



Individual Assistance Program and Policy Guide (IAPPG)

Version 1.1

FP 104-009-03 | May 2021



FEMA

This page is intentionally blank.

Table of Contents

Individual Assistance Program and Policy Guide (IAPPG).....	1
Version 1.1.....	1
Chapter 1: Introduction	3
I. Presidential Declarations.....	3
A. Types of Assistance.....	3
B. Federal Cost Share.....	5
C. Type of Incident.....	5
D. Incident Period.....	5
E. Designated Areas	5
F. FEMA-State/Territory/Tribe Agreement.....	5
II. Individual Assistance Programs Overview.....	6
A. Chapter 2: Mass Care/Emergency Assistance.....	6
B. Chapter 3: Individuals and Households Program Assistance.....	6
C. Chapter 4: Disaster Case Management (DCM).....	8
D. Chapter 5: Crisis Counseling Assistance and Training Program (CCP).....	8
E. Chapter 6: Disaster Legal Services (DLS).....	8
F. Chapter 7: Disaster Unemployment Assistance (DUA).....	9
G. Chapter 8: Voluntary Agency Coordination.....	9
III. Sequence of Delivery	10
IV. Federal Requirements for IA Programs.....	12
A. Reasonable Accommodations	12
B. Privacy Act	12
C. Nondiscrimination Requirements under the Stafford Act and Federal Civil Rights Authorities	12
D. Environmental Planning and Historic Preservation.....	13
E. Program Delivery Considerations.....	13
Chapter 2: Mass Care/Emergency Assistance.....	16
I. Overview	16
A. Period of Assistance.....	16
B. Types of Assistance.....	17
C. General Eligibility Requirements	17
D. Delivering Mass Care and Emergency Assistance MC/EA.....	17
II. Sheltering Support.....	19
A. Description of Assistance	19
B. Partner Organizations	19
C. Triggers for Implementation.....	19
D. Delivery of Assistance.....	20
III. Feeding Support	22

A. Description of Assistance	22
B. Partner Organizations	22
C. Triggers for Implementation.....	22
D. Delivery of Assistance.....	22
IV. Distribution of Emergency Supplies Support.....	25
A. Description of Assistance	25
B. Partner Organizations	25
C. Triggers for Implementation.....	26
D. Delivery of Assistance.....	26
V. Disability, Access, and Functional Needs Support.....	28
A. Description of Assistance	28
B. Partner Organizations	28
C. Triggers for Implementation.....	28
D. Delivery of Assistance.....	28
E. Personal Assistance Services.....	29
VI. Reunification Services.....	31
C. Triggers for Implementation.....	31
D. Delivery of Assistance.....	31
E. National Emergency Child Locator Center	33
VII. Household Pets, Service Animals, and Assistance Animals	34
A. Description of Assistance	34
B. Partner Organizations	34
C. Triggers for Implementation.....	34
D. Delivery of Assistance.....	34
VIII. Mass Evacuee Support	36
A. Description of Assistance	36
B. Partner Organizations	36
C. Triggers for Implementation.....	36
D. Delivery of Assistance.....	36
IX. Transitional Sheltering Assistance	38
A. Description of Assistance	38
X. Rapid Temporary Repair (Operation Blue Roof) Program	39
A. Description of Assistance	39
B. Partner Organizations	39
C. Eligibility Considerations	39
D. Delivery of Assistance.....	39
XI. National Mass Care Exercise.....	40
A. Description of Exercise	40
B. Application Process	40

C. Implementation of Exercise.....	40
Chapter 3: Individuals and Households Program.....	41
I. Individuals and Households Program Overview.....	41
A. Period of IHP Assistance.....	41
B. Amount of IHP Assistance.....	41
C. Types of IHP Assistance.....	43
II. Individuals and Households Program Eligibility.....	46
A. General IHP Eligibility.....	46
B. Additional Eligibility Considerations.....	55
C. Appeal Process.....	66
III. Delivering Individuals and Households Program Assistance.....	69
A. Applying for FEMA IHP Assistance.....	69
• Internet or Smartphone Application:.....	69
• Extensions of the Registration Period:.....	70
B. Verifying Losses.....	72
C. Applicant Communication.....	75
IV. Housing Assistance (Financial).....	78
A. Lodging Expense Reimbursement.....	78
B. Rental Assistance.....	80
C. Continued Temporary Housing Assistance.....	81
D. Rental Assistance Rate Increase.....	85
E. Home Repair Assistance.....	85
F. Privately-Owned Access Routes.....	89
G. Home Replacement Assistance.....	91
V. Housing Assistance (Direct).....	93
A. Direct Housing Assessment.....	93
B. Direct Temporary Housing Assistance Request and Approval.....	94
C. Direct Temporary Housing Assistance Conditions of Eligibility.....	96
D. Direct Temporary Housing Assistance Terms and Conditions.....	98
E. Multi-Family Lease and Repair.....	107
F. Transportable Temporary Housing Units and Site Types.....	112
G. Disposing of TTHUs through Sales to Occupants and Donations.....	119
Determining the Price of the Unit:.....	120
H. Direct Lease.....	124
I. Permanent Housing Construction.....	127
VI. Other Needs Assistance.....	145
A. ONA Options and Cost Shares.....	145
B. Non-Small Business Administration-Dependent.....	149
C. SBA-Dependent.....	166

VII.	Recovery of Program Funds	176
A.	Reasons for Recovery of Funds.....	178
B.	Identifying and Verifying Potential Debts.....	178
C.	Notice of Potential Debt and Appeal Process.....	179
D.	Debt Compromise, Suspension, or Termination	180
E.	Transfer of Debt to Treasury.....	182
F.	Statute of Limitations.....	182
Chapter 4:	Disaster Case Management.....	183
I.	Overview	183
A.	Overview of Services to Survivors.....	183
B.	Program Types.....	185
C.	Waivers to Existing Program Policy.....	185
D.	Authorities	185
II.	Immediate Disaster Case Management	186
A.	IDCM Period of Assistance.....	186
B.	Transition to Non-Federal Entity DCM Federal Award Program	186
C.	Congressional Notification Process.....	187
III.	Disaster Case Management Program.....	188
A.	Period of Assistance	188
B.	General Conditions of Eligibility for a DCM Federal award	188
C.	DCM Award Roles and Responsibilities	189
D.	Pre-Award Requirements for DCM.....	191
E.	Notice of Award (NOA)	196
F.	Post-Award Requirements for DCM.....	197
Chapter 5:	Crisis Counseling Assistance and Training Program.....	203
I.	Overview	203
A.	Overview of Services to Survivors.....	203
B.	Crisis Counseling vs. Traditional Mental Health Treatment	205
C.	Services Funded Through the CCP.....	206
D.	General Conditions of Eligibility for a Federal CCP Award.....	207
E.	Waivers to Existing Policy.....	207
F.	Authorities	207
G.	Partner Organizations	207
H.	Types of Assistance	208
II.	Immediate Services Program.....	209
A.	Period of Assistance for ISP.....	209
B.	Pre-Award Assessment and Application	209
C.	Approval Process for ISP.....	214
D.	Notice of Award (NOA) for ISP.....	215

E. Post-Award Requirements	215
F. Closeout and Records Retention	217
III. Regular Services Program	218
A. Period of Assistance for RSP.....	218
B. Pre-Award Assessment and Application	218
C. Approval Process for RSP	222
D. Notice of Award (NOA) for RSP	223
E. Post-Award Requirements	224
F. Closeout and Records Retention	226
IV. Considerations for Implementation of ISP and RSP	228
A. Main Components of a Program Management Plan.....	228
B. Media and Marketing the CCP	228
C. Staffing of the CCP.....	229
D. Data Collection, Evaluation, and Reporting.....	230
E. Quality Assurance.....	230
F. General Provisions.....	231
G. Modifications to Budget and Program Plans	232
H. Appeals	233
I. Procurement Requirements under a Federal Award.....	233
Chapter 6: Disaster Legal Services.....	235
I. Overview	235
A. Period of Assistance	235
B. Types of Assistance	235
C. Authorities	236
D. Partner Organizations	236
E. Conditions of Eligibility	236
II. Delivery of Services	237
A. Program Approval Process.....	237
Chapter 7: Disaster Unemployment Assistance	239
I. Overview	239
A. Period of Assistance	239
B. Types of Assistance.....	239
C. Application Process	239
D. Congressional Notification Process.....	240
E. Conditions of Eligibility	241
II. Delivery of Services	243
Chapter 8: Voluntary Agency Coordination.....	244
I. Overview	244
A. Voluntary Agency Coordination	244

Foreword

II. Responsibilities of FEMA Voluntary Agency Liaisons	245
A. National Response Coordination Center	245
B. Non-Declared Disasters	245
C. Emergency Declarations and Public Assistance	245
D. Volunteer and Donations Management	246
Appendix A: Section 425 Transportation Assistance.....	248
I. Authorizing Section 425 Transportation Assistance	248
A. Conditions of Eligibility	248
B. Eligible Expenses.....	249
C. Limitations and Exclusions.....	249
Appendix B: Individual Assistance Program and Assistance Approvals	250
Appendix C: Individual Assistance Policy Supersession	254
Appendix D: Federal Civil Rights Authorities Applicable to Recipients of Federal Financial Assistance.....	255
Appendix E: DCM - Allowable and Unallowable Costs.....	258
Appendix F: CCP – Allowable and Unallowable Costs	259
Appendix G: Environmental Planning and Historic Preservation Compliance.....	266
Appendix H: Definitions	270
Appendix I: Abbreviations and Acronyms.....	274
Endnotes	282

Foreword

On behalf of the Federal Emergency Management Agency (FEMA), I am pleased to present Version 1.1 of the *Individual Assistance Program and Policy Guide* (IAPPG). The IAPPG consolidates information on Individual Assistance (IA) programs offered by FEMA to a state, local, territorial, or tribal government jurisdiction affected by a disaster.

The IAPPG will:

- Supersede IAPPG Version 1.0 and the policy changes to the Individuals and Households Program resulting from the Disaster Recovery Reform Act of 2018, Section 1212 Memorandum, dated March 25, 2019;
- Provide an updated guide to programs and activities available to an affected state, local, territorial, or tribal government following a disaster; and
- Increase consistency in implementation, collaboration in planning, and the sharing of knowledge between state, local, territorial, or tribal governments, FEMA, and other Federal and non-Federal entities who assist disaster survivors.

The IAPPG will not replace the existing National Emergency Management Information System (NEMIS) business rules or internal technical manuals, as these describe FEMA's internal processes and business rules for FEMA staff.

FEMA has archived the policy, program guide, and activity documents listed in [Appendix C](#). These policy and guidance documents remain in effect for incidents declared prior to May 26, 2021. The policies reflected in this guide are effective for incidents declared on or after May 26, 2021. Any waivers to policy contained in this document must be submitted, with justification, to the IA Division Director for consideration and approval.

IAPPG Version 1.1 incorporates the following substantive updates:

List of Major Changes and Clarifications Grouped by General Topic

Administrative
Added Stafford Act requirement regarding distribution of supplies
Removed the National Mass Evacuation Tracking System (NMETS) section since it was decommissioned in September 2020
Updated Request for Federal Assistance (SF-424) definition to include the required signatories (Figure 42: RSP Application Required Information and Documents)
Added Assurances for Non-Construction Programs (SF-424B) (Figure 42: RSP Application Required Information and Documents)
Updated Delegation of IA Authorities to include the Crisis Counseling Program (CCP) Immediate Services Program (ISP) (Figure 44: Delegation of IA Authorities)
Clarified language to specify that FEMA Regional Administrators (RAs) may further delegate some of their approval authority to Federal Coordinating Officers (FCOs), with the exception of Transitional Sheltering Assistance, Crisis Counseling Program, Disaster Case Management, and Disaster Unemployment Assistance (Appendix B: Individual Assistance Program and Assistance Approvals)
Added Appendix G: Environmental Planning and Historic Preservation Compliance

Incorporation of Disaster Recovery Reform Act of 2018

Added reference to the **separate financial assistance maximum** award amounts for Housing Assistance and Other Needs Assistance ([Chapter 3: I.B. Amount of IHP Assistance](#))

Added reference to specific **disaster-damaged accessibility real property** items that can be paid in addition to the financial assistance maximum award amount for Housing Assistance ([Chapter 3: IV.E. Home Repair Assistance](#))

Updated **Multi-Family Lease and Repair** property **eligibility requirements** to include those located in an undeclared county/jurisdiction in the event MLR properties are not available within areas designated for IA ([Chapter 3: V.E.1. Multi-Family Lease and Repair](#))

Added reference to updated **two-tier approval** process for determining cost-effectiveness of **Multi-Family Lease and Repair** properties ([Chapter 3: V.E.2. Multi-Family Lease and Repair](#))

Added reference to specific **disaster-damaged accessibility personal property** items that can be paid in addition to the financial assistance maximum award amount for Other Needs Assistance ([Chapter 3: VI.A.1. Amount of Assistance](#))

Added reference to the **increase** of the **Group Flood Insurance Policy premium** to \$2,400 for all policies issues for an emergency or major disaster on or after August 1, 2019 ([Chapter 3: VI.C.3. Group Flood Insurance Policy](#))

Incorporated language on FEMA's **waiver authority for debts** that meet specific criteria ([Chapter 3: VII. Recovery of Funds](#))

Mass Care/Emergency Assistance

Added **service animal guidance** for shelter operators ([Chapter 2: II.D. Delivery of Assistance](#))

Adjusted **declaration language** under **Sheltering** section to specify that local governments cannot request declarations. Declarations may only be requested by states, tribes, and territories. ([Chapter 2: II.D. Delivery of Assistance](#))

Individuals and Households Program

Clarified that owners living in **Limited Liability Company** owned properties may be eligible for Home Repair Assistance or Home Replacement Assistance if they provide appropriate documentation ([Chapter 3: II.B.2. Limited Liability Company](#))

Updated definition for **non-traditional housing** ([Chapter 3: II.B.10. Non-Traditional Housing](#))

Delegated approval authority for **Rental Assistance rate increases** above 125% to the Individual Assistance Division Director ([Chapter 3: IV.D. Rental Assistance Rate Increase](#))

Updated the **real property verified loss threshold** to \$12 per square foot ([Chapter 3: V.C.1. Direct Temporary Housing Assistance Conditions of Eligibility](#))

Expanded alternative **documentation required** for a **direct housing major violation** to allow other documented health and safety concerns ([Chapter 3: V.D.6. Direct Temporary Housing Assistance Terms and Conditions](#))

Established the **requirement** that the applicant is responsible for any **existing pad rental costs** when FEMA provides a **Temporary Housing Unit** (TTHU) on the same site as an applicant's pre-disaster mobile home ([Chapter 3: V.F.2. Transportable Temporary Housing Units and Site Types](#))

Individuals and Households Program

Established the **requirement** that FEMA will factor reasonable **eviction costs** into the **Direct Lease** contract ([Chapter 3: V.H.2. Direct Lease](#))

Expanded **eligibility for chainsaw** reimbursement under Assistance for Miscellaneous Items ([Chapter 3: VI.B.4. Assistance for Miscellaneous Items](#))

Updated **Moving and Storage Assistance** to a **non-Small Business Administration-dependent** category of Other Needs Assistance ([Chapter 3: VI.B.5. Moving and Storage Assistance](#))

Expanded **Critical Needs Assistance eligibility** to include applicants who indicate at registration they need assistance to temporarily shelter elsewhere but have not yet left their home and other minor changes ([Chapter 3: VI.B.6. Critical Needs Assistance](#))

Established a standard award of **\$550** for **Clean and Removal Assistance** ([Chapter 3: VI.B.7. Clean and Removal Assistance](#))

Updated **documentation required** to receive **Transportation Assistance** for a destroyed vehicle ([Chapter 3: VI.C.2. Transportation Assistance](#))

Disaster Case Management

Included a timeframe of “within **60 days of receipt** of packet” for FEMA to respond to a non-federal entity’s **Disaster Case Management (DCM)** application determination or request for clarifying information ([Chapter 4: III.D.4. Federal and Congressional Review Process](#))

Crisis Counseling Assistance and Training Program

Updated **CCP eligibility** language to reflect that the state, tribal, or territorial government and FEMA must execute a FEMA-state/territorial/tribal agreement ([Chapter 5: I.D. General Conditions of Eligibility for a Federal CCP Award](#))

Clarified **CCP ISP denial specifications** by indicating an application must be received within 14 days from the date IA was authorized in the major disaster declaration ([Chapter 5: I.D. General Conditions of Eligibility for a Federal CCP Award](#))

Rephrased **CCP ISP** language to reflect **continuation** instead of extension ([Chapter 5: II.E.3. ISP Extension of the Period of Performance](#))

Added and clarified language within **CCP ISP** and **Regular Service Program (RSP)** regarding **records retention and reporting** ([Chapter 5: II.F.2. Closeout and Records Retention](#))

Voluntary Agency Coordination, and Community Services Changes

Clarified language describing the **Voluntary Agency Liaison’s (VAL’s) role** in supporting Long-Term Recovery Groups (LTRGs) through technical assistance ([Chapter 1: II.G.2. Voluntary Agency Coordination](#))

The preceding list is not inclusive of all changes to the document.

Additionally, on August 13, 2020, the Office of Management and Budget issued revisions to 2 C.F.R., including to the Uniform Administrative Requirements, Cost Principles, and Audit Requirements for Federal Awards found at Part 200. Most of the updates were effective November 12, 2020, and are applicable to Stafford Act declarations made on or after November 12, 2020. The following updated regulations were effective August 13, 2020, and are applicable to Stafford Act declarations as follows:

- System for Award Management (SAM) registration requirements at 2 C.F.R. § 25.200 (applicable to declarations made on or after August 13, 2020);
- Covered telecommunications equipment and services at 2 C.F.R. § 200.216 (applicable to all open awards; declaration date not relevant);
- Termination at 2 C.F.R. § 200.340 (applicable to declarations made on or after August 13, 2020);
- Indirect cost rates at 2 C.F.R. § 200.110(b) (allows current rates to stay in effect until they expire; declaration date not relevant); and
- New regulations on indirect costs in 2 C.F.R. Part 200, Subpart E and applicable appendices (applies to new proposals or requests made on or after August 13, 2020; declaration date not applicable).

FEMA is undertaking an extensive review of FEMA-issued grant policies and guidance documents requiring updates due to the 2 C.F.R. revisions. However, it was not possible to incorporate relevant provisions into IAPPG Version 1.1, some guidance in this document will not reflect the most recent 2 C.F.R. revisions. Where policy guidance provided in this document contradicts 2 C.F.R., 2 C.F.R. must be followed (see [Electronic Code of Federal Regulations](#)).

FEMA will conduct a comprehensive review no less than every three years. If FEMA determines it necessary to publish new or updated policy language before the next scheduled update, FEMA will update the electronic version of this document, issue a memorandum describing the additions or updates, and post both documents at www.fema.gov.



Keith Turi

Assistant Administrator, Recovery

This page is intentionally left blank.

Chapter 1: Introduction

The *Individual Assistance Program and Policy Guide* (IAPPG) consolidates information on all of FEMA's Individual Assistance (IA) programs and activities and provides a comprehensive policy resource for state,¹ local,² tribal,³ and territorial (SLTT) governments, non-governmental organization partners, and entities that participate in or support the recovery of disaster survivors.

The Robert T. Stafford Disaster Relief and Emergency Assistance Act, as amended, (Stafford Act), Public Law 93-288, 42 U.S.C. § 5121 et seq.,⁴ authorizes the President to provide Federal assistance when the magnitude of an incident or threat of an incident exceeds the affected SLTT government's capability to respond or recover.

I. Presidential Declarations

When an STT government determines an incident has exceeded their capability to respond, the Governor or Tribal Chief Executive⁵ may request a declaration from the President through FEMA. They must request the declaration within 30 days of the end of the incident. FEMA may extend the deadline if the Governor or Tribal Chief Executive submits a written time extension request within 30 days of the incident stipulating the reason for the delay.⁶

For FEMA to provide assistance, the President must declare that an emergency or major disaster exists. A declaration establishes the following:

- Types of assistance
- Federal cost share
- Type of incident
- Incident period
- Designated areas



Images of flood-damaged homes.



A. Types of Assistance

The declaration designates the types of Federal programs and assistance available. The types of assistance approved vary based on disaster needs. Assistance may be made available to SLTT governments, certain types of Private Nonprofit (PNP) organizations and faith-based organizations, or to individuals and households. The types of programs and assistance made available for emergency and major disaster declarations include those of FEMA and other Federal agencies.

FEMA provides recovery assistance through IA, Public Assistance (PA), and the Hazard Mitigation Grant Program (HMGP). Through IA programs, FEMA provides assistance to individuals and households, as well as SLTT governments to support individual survivors.

Through PA programs, FEMA provides grants to SLTT governments and certain PNP organizations to assist them with disaster response and recovery, including debris removal, emergency protective measures, and permanent restoration of facilities. FEMA provides HMGP to SLTT governments after a disaster declaration to protect eligible public or private property through various mitigation measures. For more information on PA programs and HMGP, see the [Public Assistance Program and Policy Guide \(PAPPG\)](#), FP 104-009-2, Version 4, effective June 2020, and the [Hazard Mitigation Assistance Grants Guidance](#).

Programs are authorized based on the need of the disaster. IA programs made available under emergency declarations are limited to supplemental emergency assistance to the affected state, territory, or tribal (STT) government to provide immediate and short-term assistance essential to save lives, protect public property, health, and safety, or to lessen or avert the threat of a catastrophe. IA’s Mass Care and Emergency Assistance program is always made available under an emergency declaration. Although rare, Individuals and Households Program (IHP) assistance under Section 408 of the Stafford Act may be made available under an emergency declaration.

All IA programs may be authorized once a major disaster has been declared by the President.⁷ The approval of IA under a major disaster declaration may also activate assistance programs provided by other Federal agencies based on specific disaster needs. *Figure 1* displays the IA programs that may be provided under emergency declarations and major disaster declarations.



*Above: A disaster-destroyed home.
Below: Volunteers repair a home.*

Figure 1: Available IA Programs for Emergency and Major Disaster Declarations		
Individual Assistance Program	Emergency Declaration	Major Disaster Declaration
Mass Care/Emergency Services	✓	✓
Individuals and Households Program	✓	✓
Disaster Case Management		✓
Crisis Counseling Assistance and Training Program		✓
Disaster Legal Services		✓
Disaster Unemployment Assistance		✓
Voluntary Agency Coordination ⁸	✓	✓

B. Federal Cost Share

The assistance FEMA provides through its PA program and some types of IA are subject to a cost share. For IA, FEMA provides 100% of IHP Housing Assistance, Disaster Case Management (DCM), Disaster Unemployment Assistance (DUA), Disaster Legal Services (DLS), and Crisis Counseling and Training Program (CCP) costs.⁹ However, IHP Other Needs Assistance (ONA) and Transitional Sheltering Assistance (TSA)¹⁰ are subject to a cost share between FEMA and the STT government. FEMA covers 75% of eligible ONA and TSA costs, and the STT government is responsible for the remaining 25%. ONA cost share is fixed by statute. The TSA cost share adjustment may be approved by the President¹¹ on an individual disaster basis.

C. Type of Incident

The declaration designates the type of incident (e.g., hurricane, tsunami, earthquake, etc.). An emergency declaration¹² is any instance the President determines warrants supplemental emergency assistance to the STT government to save lives and protect property, public health, and safety, or to lessen or avert the threat of a catastrophe.

A major disaster declaration is any natural catastrophe (e.g., earthquake, hurricane, flood, tornado, volcanic eruption, severe winter weather, storm surge, tsunami, wildfires, landslide, mudslide, extreme winter weather, snowstorm, high winds, ice storm, straight line winds, drought) or man-made hazards (e.g., fire, explosion, technological failure), regardless of cause, that produces damage of sufficient severity and magnitude in the President's determination to warrant supplemental assistance to an STT government.¹³ Major disaster declarations may include a combination of incident types, including man-made and natural.

D. Incident Period

The incident period¹⁴ is established by FEMA in the FEMA-State/Territory/Tribe Agreement¹⁵ and published in the Federal Register.¹⁶ The incident period is the time interval during which the Presidentially-declared incident occurs, causing losses and/or damage. This period varies in length, depending on the incident.

E. Designated Areas

The declaration designates which counties, parishes, tribes or tribal lands, municipalities, villages, or districts¹⁷ are eligible to receive Federal assistance. The Governor, Governor's Authorized Representative (GAR), Tribal Chief Executive, or Tribal Chief Executive's Authorized Representative (TAR) may request the designation of additional areas within 30 days of the declaration or the end of the incident period, whichever is later.

F. FEMA-State/Territory/Tribe Agreement

After every declaration, FEMA and the STT government enter into an agreement documenting the understanding, commitments, and conditions under which FEMA will provide assistance (FEMA-State/Territory/Tribe Agreement).¹⁸ FEMA and the Governor or Tribal Chief Executive must sign this agreement before FEMA provides Other Needs Assistance.

The FEMA-State/Territory/Tribe Agreement incorporates the DHS Standard Terms and Conditions in effect on the date the event was declared. Among the DHS Standard Terms and Conditions are federal civil rights obligations applicable to recipients of federal financial assistance.¹⁹ See [Appendix D: Federal Civil Rights Authorities Applicable to Recipients of Federal Financial Assistance](#).

II. Individual Assistance Programs Overview

A. Chapter 2: Mass Care/Emergency Assistance

1. Overview

Mass Care and Emergency Assistance (MC/EA) is the provision of life-sustaining services to disaster survivors as defined in the National Response Framework. MC/EA services are provided immediately before a potential incident, during the immediate response to an incident, and during the beginning of the post-disaster recovery effort. To provide more effective coordination, FEMA may deploy MC/EA staff and resources to the National Response Coordination Center (NRCC), Regional Response Coordination Center (RRCC), FEMA Joint Field Office (JFO), and/or SLTT Emergency Operations Centers (EOC).

In the event of a Presidentially-declared disaster, all impacted survivors are eligible to receive MC/EA services.

2. Types of Services and Delivery

MC/EA comprises seven services known as activities. Activities include: sheltering; feeding; distribution of emergency supplies; support for individuals with disabilities and others with access and functional needs; reunification services for adults and children; support for household pets, service animals, and assistance animals (HPSA); and mass evacuee support. In addition to these seven activities, MC/EA also supports the National Mass Care Exercise (NMCE) training program and offers partnerships through the Blue Roof Program and Transitional Sheltering Assistance (TSA).

MC/EA supports the whole community approach to emergency management. By engaging state, territorial, and tribal governments, National Voluntary Organizations Active in Disaster (National VOAD), and other various entities involved in delivering post-disaster aid, MC/EA increases capacity to meet the life-sustaining needs of survivors in catastrophic disasters. MC/EA coordinates the delivery of assistance for both pre-disaster preparedness and post-disaster emergency support to individuals. Pre-disaster technical assistance is provided to organizations critical in supporting mass care, including: FEMA's Response, Recovery, and Logistic Management Directorates; the National Preparedness Directorate; SLTT governments; FEMA Regions; and other Federal agencies.

B. Chapter 3: Individuals and Households Program Assistance

1. Overview

IHP assistance provides financial assistance and direct services to eligible individuals and households who have uninsured or underinsured necessary expenses and serious needs as a result of a Presidentially-declared disaster. IHP assistance is not a substitute for insurance and cannot compensate for all losses caused by a disaster; it is intended to meet basic needs and supplement disaster recovery efforts. IHP assistance is not considered income²⁰ or a resource when determining eligibility for welfare, income assistance, or income-tested benefit programs that the Federal Government funds, such as Social Security benefits or disability income. IHP assistance is also exempt from garnishment or seizure²¹, but this exception does not apply to assistance recovered by FEMA after being received in error or fraud.

2. Types of Services and Delivery

IHP assistance comprises two provisions, Housing Assistance and Other Needs Assistance (ONA)²². Housing Assistance may be provided in the form of financial assistance (funds provided to an applicant) or direct assistance (housing provided to the applicant by FEMA). Examples of financial assistance include Lodging Expense Reimbursement (LER), Rental Assistance, Home Repair Assistance, and Home Replacement Assistance. Examples of direct assistance²³ include Multi-Family Lease and Repair (MLR); Transportable Temporary Housing Units (TTHUs), such as Recreational Vehicles (RVs) or Manufactured Housing Units (MHUs); Direct Lease; and Permanent Housing Construction (PHC).

Some types of ONA may only be provided if an applicant does not qualify for a disaster loan from the U.S. Small Business Administration (SBA)²⁴; these are known as SBA-dependent types of ONA and include Personal Property Assistance, Transportation Assistance, and Group Flood Insurance Policy (GFIP). Non-SBA-dependent ONA includes Funeral Assistance, Medical and Dental Assistance, Child Care Assistance, Assistance for Miscellaneous Items, Moving and Storage Assistance, Critical Needs Assistance, and Clean and Removal Assistance.



FEMA disaster assistance staff provide applicants information on FEMA programs.

IHP assistance is limited to 18 months following the date of the Presidential disaster declaration;²⁵ however, FEMA may extend the period of assistance due to extraordinary circumstances.

C. Chapter 4: Disaster Case Management (DCM)

1. Overview

DCM is a time-limited process that promotes partnership between a case manager and a disaster survivor in order to assess and address a survivor's verified disaster-caused unmet needs through a disaster recovery plan²⁶. This disaster recovery plan includes resources, decision-making priorities, guidance, and tools to assist disaster survivors.

2. Types of Services and Delivery

FEMA is authorized to provide case management services, to include financial assistance, to SLTT government agencies or qualified private organizations (non-Federal entities), so that they may provide case management services to survivors in order to identify and address disaster-caused unmet needs.

D. Chapter 5: Crisis Counseling Assistance and Training Program (CCP)

1. Overview

CCP²⁷ provides supplemental funding to eligible SLTT governments and non-governmental organizations to assist disaster-impacted individuals and communities in recovering from the major disasters through the provision of community-based outreach and psycho-educational services. The goal is to aid survivors in recovering from the adverse reactions to disasters and to begin to rebuild their lives.

2. Types of Service and Delivery

CCP services include funding for supportive crisis counseling, psycho-education, development of coping skills, and linkages to appropriate resources. CCP services are separated into two categories: primary and secondary. Primary services are high-intensity and include crisis counseling, public education, and community support. Secondary services are those that have a broader scope. These include the development and distribution of educational material as well as media and public service announcements.

CCP services are available through the Immediate Services Program (ISP) and the Regular Services Program (RSP). ISP provides funding for up to 60 days following a major disaster declaration with IA. RSP provides longer-term funding for up to nine months from the notice of award.

E. Chapter 6: Disaster Legal Services (DLS)

1. Overview

DLS²⁸ provides legal aid to low income survivors affected by a Presidentially-declared major disaster through an agreement with the Young Lawyers Division (YLD) of the American Bar Association.

2. Types of Services and Delivery

DLS is limited to cases that would not normally incur legal fees. Typically, the types of legal assistance offered include help with insurance claims (e.g., health, property, or life), recovery or reproduction of legal documents lost in the disaster, help with home repairs and disputes with contractors and/or landlords, the preparation of powers of attorney and guardianship materials, and FEMA appeals.

F. Chapter 7: Disaster Unemployment Assistance (DUA)

1. Overview

DUA²⁹ provides unemployment benefits and re-employment assistance services to survivors affected by a Presidentially-declared major disaster. These services are under the responsibility of the U.S. Department of Labor and administered by the SLTT government emergency management officials of the affected area(s). DUA is only available to those survivors who are not eligible for regular state unemployment insurance (UI).

2. Types of Services and Delivery

State law determines the amount of disaster unemployment assistance a survivor may receive, so the amount of assistance varies state-to-state and disaster-to-disaster. DUA is a finite assistance tool: benefits are usually paid for up to 26 weeks after the disaster declaration. The continuation of assistance is dependent upon the survivor's period of unemployment as a direct result of the disaster.

G. Chapter 8: Voluntary Agency Coordination

1. Overview

Voluntary agencies are among the first to provide survivor support services post-disaster and continue throughout the recovery period; they complement Federally-provided assistance and may support gaps in coverage. FEMA's Voluntary Agency Coordination Section is staffed by personnel known as Voluntary Agency Liaisons (VALs). VALs establish and maintain relationships among Federal and SLTT governments, as well as voluntary, faith-based and community organizations active in preparedness, response, and recovery; coordinate with Voluntary Organizations Active in Disaster (VOAD) at the national, state, territorial, tribal, and local levels; assist with translating and navigating Federal programs for their stakeholders; provide technical guidance and support with donations, unaffiliated and spontaneous volunteer management; and collaborate with and support non-government organizations (NGOs) that deliver an array of disaster relief services to affected jurisdictions.

VALs are not a program-based function, thereby affording the flexibility to respond to Stafford Act declarations for Individual Assistance and Public Assistance, as well as non-Stafford Act events whereby technical expertise in convening social service organizations is needed to support other Federal agencies in times of crisis.

2. Types of Services and Delivery

FEMA VALs play a variety of roles in all types of disasters—IA disaster declarations, PA disaster declarations, and non-Presidentially-declared disasters—since these events are local and voluntary agencies are so often both the first and the last to provide assistance to survivors with immediate and unmet needs, FEMA VALs may support differently throughout the disaster lifecycle. They work to support this process by providing advice, perspective, and other forms of technical assistance to form and re-form Long-Term Recovery Groups (LTRGs) and helping to identify community-based, faith-based, voluntary, and private sector organizations to help fill gaps. They also gather, evaluate, and distribute information including damage assessments and other situational awareness that helps identify and predict needs, resources, stakeholders, community leaders, and organizations to support the long-term recovery process.

III. Sequence of Delivery

The sequence of delivery establishes the order in which disaster relief agencies and organizations provide assistance to disaster survivors.³⁰ A clear sequence of delivery prevents duplication of benefits, maximizes available resources, and organizes efforts to help disaster survivors navigate the recovery process.

Figure 2 shows the sequence of delivery after a disaster.

Figure 2: Disaster Assistance Sequence of Delivery

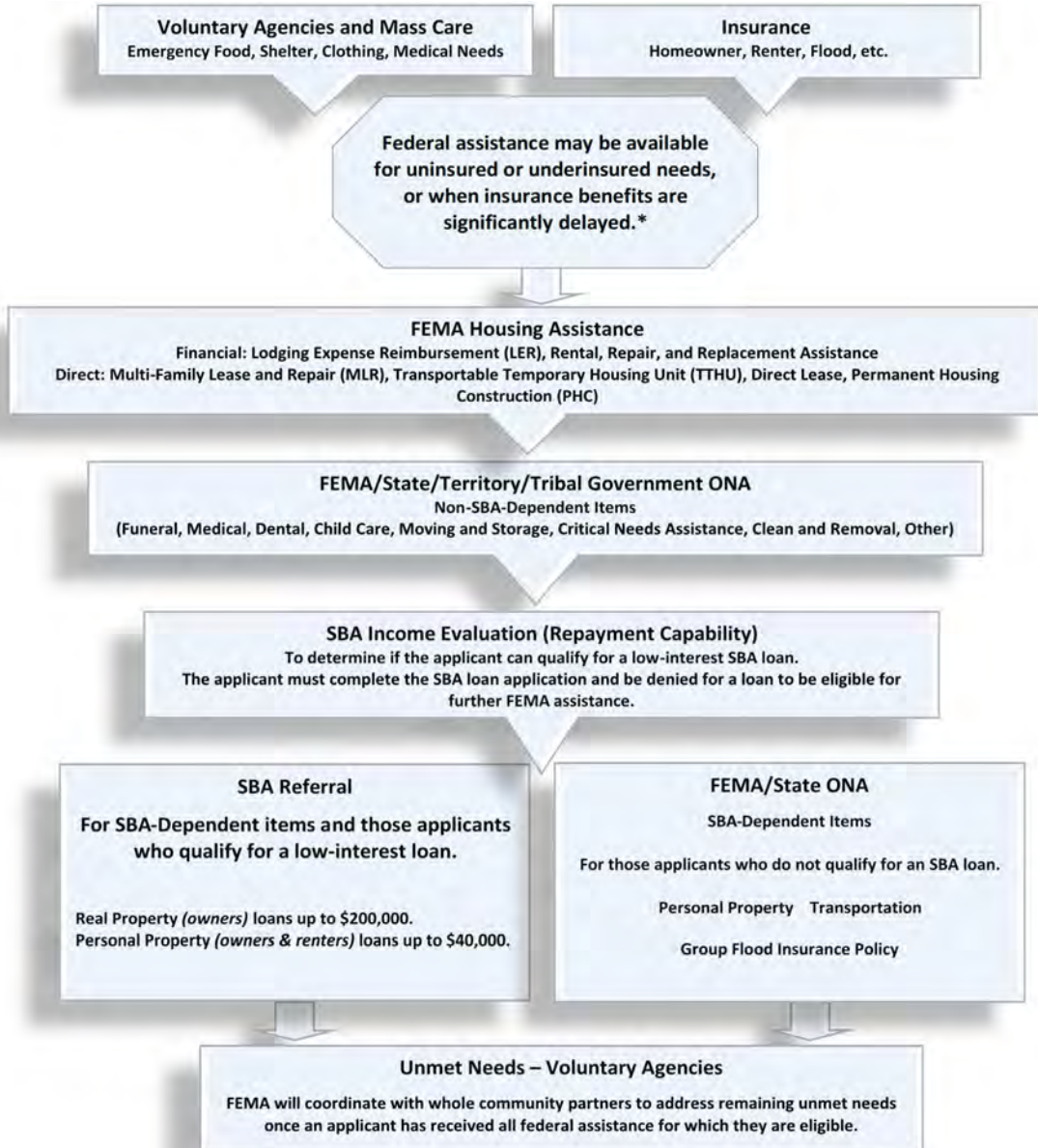

**Eligibility for Federal assistance is based on each applicant’s individual circumstances as they relate to each program’s conditions of eligibility. Not all applicants will be eligible for all forms of Federal assistance.*

Figure 3 shows a timeline of IA programs.

Figure 3: Timeline of Individual Assistance Programs

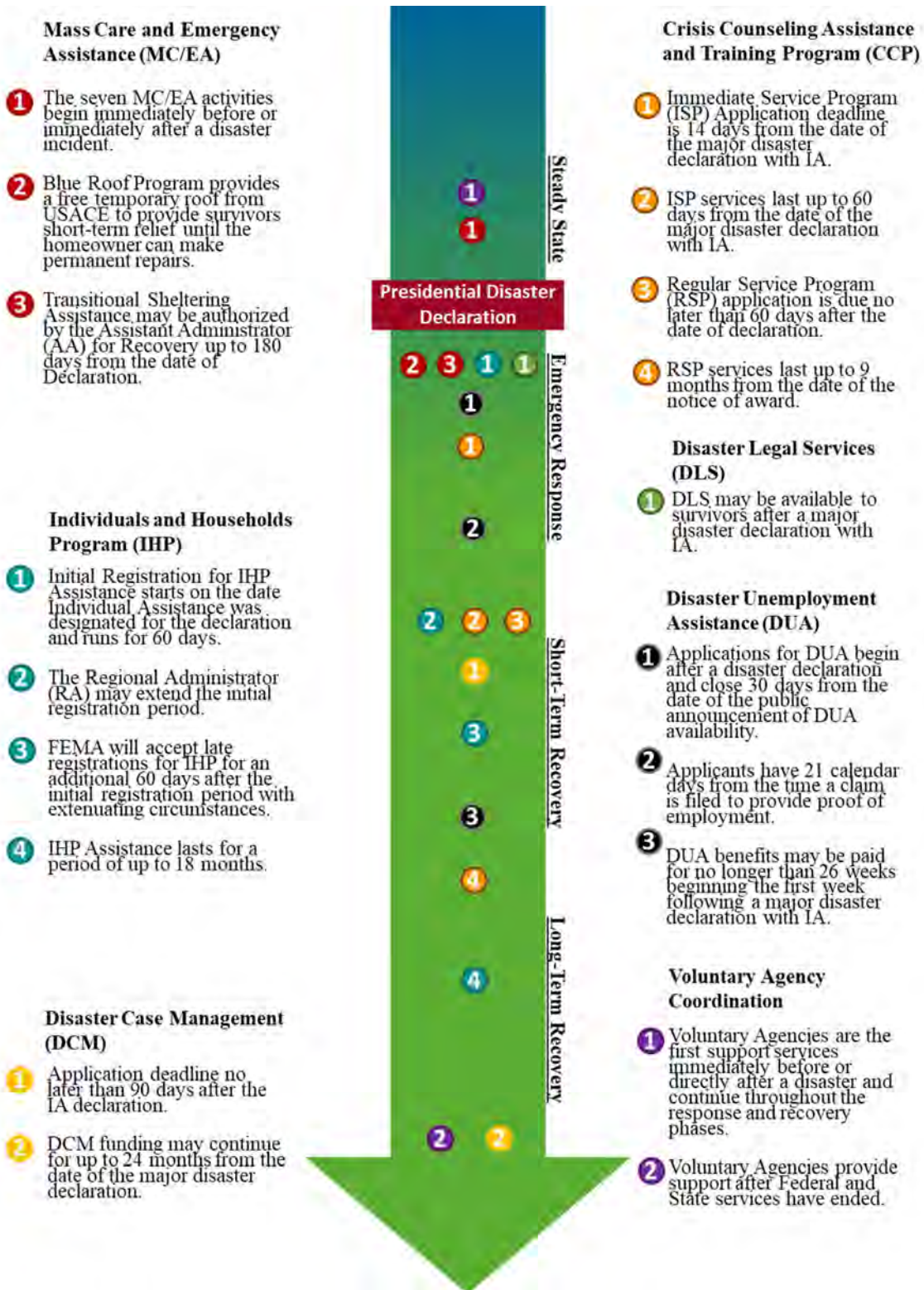

IV. Federal Requirements for IA Programs

A. Reasonable Accommodations

FEMA makes reasonable accommodations to policies, practices, and procedures to ensure physical, programmatic, and effective communication access to FEMA disaster assistance. For example, FEMA may provide technologies and services to ensure effective communication with applicants with limited English proficiency (LEP), qualified applicants with disabilities, and others with access and functional needs.

For additional information, see [Chapter 1, IV. E.](#)

B. Privacy Act

Determining eligibility for FEMA assistance requires applicants to provide personal information, such as a Social Security Number (SSN), home address, and household income.

The Privacy Act of 1974 regulates how FEMA collects, uses, and discloses an applicant's personal information in order to protect the privacy of the applicant. For example, FEMA employees and contractors will always verify an applicant's identity before discussing eligibility or potential assistance.

All FEMA staff and contractors will present an identification badge to ensure applicants know they are providing private information to a trusted FEMA representative.

C. Nondiscrimination Requirements under the Stafford Act and Federal Civil Rights Authorities

Sections 308 and 309 of the Stafford Act, and Section 504 of the Rehabilitation Act of 1973³¹ have nondiscrimination provisions applicable to FEMA programs and prohibit discrimination on the grounds of race, color, religion, [national origin], sex, age, disability, English proficiency, or economic status. FEMA also has civil rights obligations under Executive Order 13166, "Improving Access to Services for Persons with Limited English Proficiency," and Executive Order 12898, "Environmental Justice in Minority and Low-Income Populations." Additionally, Title VI of the Civil Rights Act, Section 504 of the Rehabilitation Act, Title IX of the Education Amendments Act, and the Age Discrimination Act have similar nondiscrimination provisions applicable to FEMA recipients.



Reasonable Accommodations

Applicants may request reasonable accommodations to access FEMA programs and services at any time, including during registration, inspection, community meetings, briefings, or any other event when FEMA is present.



Privacy Act

The Privacy Act of 1974 protects the applicant's rights as to how FEMA uses and shares personal information. The Stafford Act and other authorities allow FEMA to collect personal information to determine eligibility and administer FEMA disaster assistance as a result of an Emergency or a Presidentially-declared disaster. Information shared with other Federal agencies will not be used for any purpose other than assisting the applicant's recovery, preventing duplication of benefits, or informing other disaster recovery programs.

FEMA may share the applicant's information outside of FEMA with entities such as state, territorial, tribal, and local governments, voluntary organizations, and other organizations in accordance with published routine uses identified in *DHS/FEMA-008 Disaster Recovery Assistance Files System of Records Notice*. FEMA shares this information to enable the applicant to receive additional disaster assistance, prevent a duplication of benefits, and prevent future disaster losses.

Section 504 of the Rehabilitation Act requires that FEMA and FEMA recipients, including SLTT partners, ensure nondiscrimination for individuals with disabilities by providing equal access to programs, physical accessibility of facilities, effective communications, and reasonable accommodations. Non-federal recipients of financial assistance from FEMA have an obligation to take reasonable steps to provide meaningful access to persons with limited English proficiency, as required by Title VI of the Civil Rights Act of 1964 and FEMA’s implementing regulations. This requirement is similar to FEMA’s obligation under Executive Order 13166 to individuals with limited English proficiency.

D. Environmental Planning and Historic Preservation

Federal Environmental Planning and Historic Preservation (EHP) laws, regulations, and executive orders (EOs) establish requirements to protect the environment and preserve historical and cultural resources. Federally-funded IA grants and programs are subject to compliance with EHP compliance requirements, including but not limited to, the National Environmental Policy Act; EO 11988 Floodplain Management; EO 11990, Protection of Wetlands; Endangered Species Act; and the National Historic Preservation Act.

FEMA addresses EHP compliance requirements early in the project scoping and development stages to minimize delays and additional costs. In addition, FEMA works with other Federal agencies and SLTT governments to identify opportunities for implementing measures for the conservation of threatened and endangered species, as well as their designated critical habitat, when appropriate and feasible. EHP compliance may require modification to a project’s scope of work, consideration of alternate site locations, and obtainment of applicable permits. See [Appendix G: Environmental Planning and Historic Preservation](#) for a description of common EHP laws, regulations, and EOs.

E. Program Delivery Considerations

FEMA is responsible for addressing and fulfilling requests for disability access and language access from applicants, including during housing inspections, in an effective and timely manner.

Definitions

The terms “Individual with a Disability” and “Access and Functional Needs” are not synonymous and should not be used interchangeably. The terms have the following meaning:

Individual with a Disability: Individual who has a physical or mental impairment that substantially limits one or more major life activities (an “actual disability”), or a record of a physical or mental impairment that substantially limits a major life activity (“record of”), or an actual or perceived impairment, whether or not the impairment limits or is perceived to limit a major life activity, that is not both transitory and minor (“regarded as”). Individuals with disabilities have civil rights protections that may not be waived under any circumstances, including throughout emergencies and disasters.

Access and Functional Needs: Individuals having access and functional needs may include, but are not limited to, people with disabilities, older adults, and individuals with limited English proficiency, limited access to transportation, and/or limited access to financial resources to prepare for, respond to, and recover from the emergency. Federal civil rights law and policy require nondiscrimination, including on the basis of race, color, national origin, religion, sex, age, disability, English proficiency, and economic status. Many individuals with access and functional needs are protected by these provisions.

1. Applicants with Disabilities

Under Section 504 of the Rehabilitation Act of 1973 and Section 308 of the Stafford Act³², FEMA is required to provide reasonable accommodations or modifications, to policies, practices, and procedures to ensure equal access to qualified applicants with disabilities. Reasonable accommodations may include the provision of technologies and services to ensure equal access to disaster assistance.

Disaster survivors with disabilities have a right to equal access to FEMA programs and activities, including FEMA’s registration process and housing inspections, physical access to facilities, and effective communication. FEMA provides reasonable accommodations or program modifications to provide access to qualified individuals with disabilities under Section 504 of the Rehabilitation Act and under Section 308 of the Stafford Act. When providing a modification to ensure effective communication with and between qualified individuals with disabilities, FEMA will give primary consideration to the auxiliary aid requested by each individual with the disability.

FEMA may also provide effective communication access to applicants with disabilities. Effective communication access and program access may include, but is not limited to:

- American Sign Language (ASL) interpreter
- Video Relay Interpreting (VRI)
- Assistive listening devices
- Assistive reading devices
- Braille/large print documents
- Reading assistance services
- Accessible DRCs that comply with the Architectural Barriers Act and Section 504 of the Rehabilitation Act, to include: wheelchair accessibility into the facility, accessible restrooms, and accessible paths of travel from the parking lot and throughout the facility, as well as technology to provide effective communication access to individuals with disabilities
- ASL interpreters and/or Communication Access Real-time Translation (CART) at DRCs and public/community outreach events, upon request, and field staff equipped with tablet computers that can access VRI for applicants who use ASL Assistance and program modification for applicants having difficulty understanding the registration process, denial letters, or the appeal process

2. Applicants with Limited English Proficiency

FEMA ensures all applicants receive critical, accessible, and understandable disaster assistance communications, regardless of language proficiency. Under Sections 308 and 616 of the Stafford Act and Executive Order 13166, “Improving Access to Services for Persons with Limited English Proficiency,” FEMA must provide applicants with limited English proficiency (LEP) meaningful access to its programs and services.³³

Applicants with LEP are entitled to communicate with FEMA and receive information from FEMA in a language other than English.

To best assist applicants with LEP, FEMA provides all the following:

- Disaster information and multi-lingual signage in languages identified through demographic analysis of the impacted area;
- Translation and interpretation services (provided by qualified translators and interpreters) available in 250 languages to assist non-English-speaking disaster survivors;
- Staff to identify language needs and connect disaster survivors to applicable translation services by qualified translators;
- Appropriate referrals for applicants with disabilities and others with access and functional needs who also have LEP; and
- Spanish language instructions through <https://www.disasterassistance.gov/es> where individuals can register for assistance.

Chapter 2: Mass Care/Emergency Assistance

I. Overview

FEMA Mass Care/Emergency Assistance (MC/EA) provides coordination and support to state, local, tribal, and territorial (SLTT) governments and/or jurisdictions for the provision and/or direct delivery of life-sustaining services to disaster survivors as defined in the National Response Framework, Emergency Support Function #6 (ESF #6).³⁴ The National Mass Care Strategy—the strategy which underlies capacity development for and deployment of MC/EA services—was developed in partnership with the American Red Cross and other mass care practitioners and serves as a Federal guide for the provision of national mass care capability. FEMA is committed to supporting the further development and implementation of the strategy and its goals by:

- Providing technical assistance such as planning support, subject matter expertise, etc.;
- Financing invitational travel and supporting National Mass Care Exercises;
- Hosting webinars;
- Co-branding guidance documents and tools; and
- Serving as the convener and facilitating the engagement of the public and private sector in the creation of multi-agency guidance and templates.

In support of its mission, MC/EA may deploy staff and resources to the National Response Coordination Center (NRCC), Regional Response Coordination Center (RRCC), FEMA Interim Operation Facility (IOF), FEMA Joint Field Office (JFO), FEMA Area Field Office (AFO), SLTT government Emergency Operations Center (EOC), and/or other field assignment settings.

During Presidentially-declared disasters, most MC/EA services are funded under the Stafford Act Section 403³⁵ subject to the applicable cost share. Section 403 assistance for MC/EA services may be provided via Direct Federal Assistance (DFA).

A. Period of Assistance

MC/EA services may be provided before a potential incident, during the immediate response to an incident, and during the recovery phase after a disaster or incident.



FEMA Mass Care Specialist and Southern Baptist Disaster Relief nurse place donated respirators in a storage unit in Moore, Oklahoma following a tornado.

B. Types of Assistance

FEMA MC/EA is responsible for the coordination of seven activities or services detailed under the MC/EA functions of ESF #6 and has a unique partnership with the American Red Cross as the co-lead agency for the Mass Care component of ESF #6. The seven activities included are:

- Sheltering (congregate and non-congregate);
- Feeding;
- Distribution of emergency supplies (including but not limited to, medications, baby diapers and formula, clothing from donation management, Commonly Used Shelter Items (CUSI), mobile feeding, meal preparation kits, and other commodities);
- Support to individuals with disabilities and others with access and functional needs;
- Reunification services for adults and children;
- Support to HPSA; and
- Mass evacuee support.

In addition to these seven activities, FEMA MC/EA supports training and exercises, like the National Mass Care Exercise (NMCE) and also provides partnered assistance through:

- Transitional Sheltering Assistance (TSA)
- Blue Roof program (United States Army Corps of Engineers [USACE])



US Army Corps of Engineers' Blue Roof Program helps to prevent further damage to structures as a result of Hurricane Katrina in Biloxi, Mississippi.

C. General Eligibility Requirements

All survivors impacted by a disaster are eligible to receive MC/EA services. There is no application process for MC/EA services as these are most often life sustaining. These programs will be delivered directly to disaster survivors and impacted communities typically through SLTT partners and nonprofits with technical assistance and resource support from FEMA. Two notable exceptions to this general rule are the [TSA \(See Chapter 2, IX\)](#) and the [Blue Roof Program \(See Chapter 2, X\)](#), which do have specific eligibility criteria.

D. Delivering Mass Care and Emergency Assistance MC/EA

FEMA MC/EA coordinates and supports assistance for both pre-disaster preparedness and post-disaster emergency support to individuals through other FEMA divisions, Federal agencies, partner SLTT governments, and non-governmental organizations (NGOs).

Pre-disaster technical assistance is provided to:

- FEMA’s Response, Recovery, and Logistics Management Directorates in the development of national and regional response and recovery operational plans, catastrophic plans, and other critical operational planning documents and activities;
- The National Preparedness Directorate in the development and implementation of FEMA doctrine, Planning Guidance, the Resource Typing initiative, the National Exercise Program, and the National Preparedness Report as well as fulfillment of Presidential Policy Directive 8 (PPD-8) requirements; and
- SLTT governments, FEMA Regions, and other Federal agencies including, but not limited to USACE, Corporation for National and Community Service (CNCS), General Services Administration (GSA), the Department of Health and Human Services (HHS), the United States Department of Agriculture (USDA), the United States Department of Veterans Affairs (VA), and the Department of Defense (DOD).

FEMA is committed to the whole community approach to emergency management and works through the FEMA Regions to engage SLTT community experts to identify capabilities, capacities, anticipated shortfalls, and gaps. FEMA MC/EA works with government agencies, voluntary, community, faith-based organizations, and social services providers that advocate on behalf of –or support– individuals with disabilities, individuals with limited English proficiency, low-income populations, underserved communities, and diverse faith communities to secure the development of multi-agency guidance, planning templates, training, and other resources through pre-scripted mission assignments (PSMAs), interagency agreements (IAAs), and memoranda of agreement (MOAs) to expedite the ability to meet anticipated needs. Resources and services provided via PSMA, IAA, and MOA include but are not limited to, staffing for NRCC/RRCC/State EOC, Blue Roof program mission for USACE, shelter support, AmeriCorps assistance from CNCS, Retired and Senior Volunteer Program (RSVP) under CNCS, activation of National Disaster Medical System (NDMS), etc.

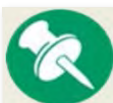

Tools and Resources

CUSI: Includes durable medical equipment (DME) items, consumable medical supplies (CMS) items, hygiene kits, and other relevant items. Information resources available at:

- [National Mass Care Strategy Website](#)
- Federal, SLTT government software systems (e.g., WebEOC)
- Multi-Agency Distribution of Emergency Supplies Plan Template

II. Sheltering Support

A. Description of Assistance

FEMA MC/EA deploys equipment, materials, supplies, and personnel to support disaster-affected jurisdictions in providing life-sustaining services in congregate and non-congregate facilities that provide a secure and sanitary environment for displaced survivors. This support includes providing a safe, sanitary, and secure place for evacuees and disaster survivors to stay while displaced from their homes and requires the cooperation and coordination of multiple agencies and organizations. MC/EA also coordinates support to survivors sheltering in place, people with disabilities and others with access and functional needs, dietary restrictions, HPSA, and survivors in ESF #8 medical shelters.

People with disabilities and others with access and functional needs are to be accommodated in general population shelters. If requested, MC/EA can assist with durable medical equipment (DME), consumable medical supplies (CMS), personal assistance services (PAS), etc. to provide a basic level of care in congregate shelters and thus ensure that only survivors with acute medical needs are referred to ESF #8 medical shelters. FEMA can provide needed resources through in-house capabilities, mission assignments, and/or contract capabilities.

During Presidentially-declared disasters, most MC/EA services are direct Federal assistance (DFA), which are funded under the Stafford Act Section 403 (a)(3)(B) (commonly referred to as Category B) of a major disaster or emergency declaration, and the Federal share of assistance shall be not less than 75% of eligible cost. Some examples of DFA include non-congregate sheltering through TSA, feeding through Individual Assistance-Support Contracts (IASC), and reunification services under the National Center for Missing and Exploited Children.³⁶

B. Partner Organizations

MC/EA works with multiple partners in sheltering support efforts including: the American Red Cross, the CNCS, Adventist Community Services (ACS), the Salvation Army, Send Relief, National Animal Rescue and Sheltering Coalition (NARSC), National Coalition for the Homeless, Convoy of Hope, Feeding America, other National Voluntary Organizations Active in Disaster (National VOAD), and many others.

C. Triggers for Implementation

In the event of a natural or manmade disaster, sheltering support services are triggered by an emergency declaration or a major disaster declaration authorizing Public Assistance (Category B) when requested by STT governments. There is no individual application process required for survivors.

D. Delivery of Assistance

Pre-disaster responsibilities include preparedness activities and other forms of technical assistance that do not require Category B funding such as:

- Providing technical assistance for the development of multi-agency sheltering templates; Federal, STT government plans; training materials; exercises; and other tools to strengthen and enhance the nation's capacity to support sheltering activities;
- Analyzing and incorporating best practices and lessons learned into preparedness activities, including reminding shelter operators that service animals are permitted in general population shelters and should not be separated from their handlers;
- Developing contracts, PSMAs, agreements, and other mechanisms to provide resources, programs, and services for sheltering during disaster response activities;
- Expanding national capabilities beyond the traditional MC/EA shelter providers to meet Federal Interagency Operational Planning (FIOP) - Response metrics;
- Providing technical assistance for the establishment of STT sheltering task forces;
- Providing training to whole community shelter providers;
- Providing technical assistance for implementation of FEMA data systems, including the National Shelter System, which supports STT governments with MC/EA planning, data analysis, and mapping and reporting; and
- Providing subject matter expertise to internal partners, including, Response, Recovery, Logistics and National Preparedness Directorates, PA, Office of Disability Integration and Coordination, and the National Processing Service Center.



FEMA coordinates with partners, like the American Red Cross, to provide temporary sheltering support for disaster evacuees.

Once a disaster has been declared, FEMA MC/EA provides post-disaster support, such as:

- Coordinating with other Federal agencies; STT governments; NGOs; and other partners to analyze and validate the need for human and material resources, programs, and services for sheltering;
- Providing subject matter expertise/technical assistance in the NRCC, RRCC, FEMA JFO, Initial Operating Facility (IOF), State EOC, and/or other field settings;
- Assisting the state in the implementation of a coordinated and integrated sheltering mission that meets the disaster-caused needs of evacuees and survivors;
- Providing resource support through FEMA Logistics, including equipment, material, supplies, facilities, shelf-stable meals, water, cots, blankets, and personnel, to support STT sheltering operations through mission assignments, contracts, and other mechanisms;
- Monitoring activity, analyzing data, validating information, and reporting on sheltering activities;

- Identifying resource requirements, shortfalls, and limiting factors;
- Providing tools and resources to assist the SLTT government in the implementation of integrated strategies and processes for coordinated sheltering operations;
- Monitoring, analyzing, validating, and supporting state requirements, as requested, in order to provide a safe, sanitary, and secure environment for shelter residents;
- Facilitating the fulfillment of requests by ensuring that the sequence for obtaining resources is followed;
- Providing evacuee and survivor support to SLTT governments through the activation of pre-negotiated blanket purchase agreements (BPAs) and indefinite delivery indefinite quantity (IDIQ) contracts for food and food supplies, DME, CMS, and other needed commodities;
- Supporting SLTT governments during a disaster when sheltering operations needs exceed SLTT government capabilities as outlined in the National Response Framework ESF #6 Annex;
- Providing the necessary tools and resources to develop an integrated strategy and process for implementing coordinated sheltering operations by the FEMA JFO and the STT government coordinator for carrying out mass care activities, limiting duplication of efforts, and maximizing resources within any STT government that has requested Federal assistance;
- Facilitating FEMA staff's access to congregate care facilities to assist in the registration of disaster survivors for Federal disaster assistance;
- Providing staff support to state for Sheltering Task Forces, Multi-agency Sheltering Transition Teams, or other teams that advise and assist shelter managers with shortfalls and other concerns that may fall outside their area of expertise (e.g., functional needs support and Americans with Disabilities Act [ADA] compliance). See <http://www.nationalmasscarestrategy.org> for more information;
- Providing technical assistance for the ESF #6 Support System, which can support the state with congregate care planning, data analysis, mapping, and reporting;
- Providing support for the collection of shelter information, including data entry (upon request);
- Issuing mission assignments to other Federal agencies, including but not limited to: CNCS to provide AmeriCorps, Senior Corps, and/or Volunteers in Service to America (VISTA) members to augment congregate care points of distribution and other operational staffing requirements; HHS for shelter assessment team staff support; USDA for subject matter expertise and technical assistance on HPSA support activities; and USACE for human and material resources, such as facility inspection teams;
- Providing NGOs and other partners with travel funds to support the ESF #6 functions with essential technical assistance through invitational travel; Requesting other federal agencies and individuals to support the mission of MC/EA and augment the leadership team with agency expertise; and
- Activating IASC, which can provide a full range of congregate care management and support resources. As IASC services are subject to STT government cost-share, activation of the IASC is generally considered the last option.

III. Feeding Support

A. Description of Assistance

FEMA MC/EA Section deploys equipment, materials, supplies, and personnel to support SLTT governmental feeding services to evacuees, disaster survivors and their HPSA, and, in some cases, emergency workers. FEMA and Red Cross (ESF #6 Mass Care Federal Co-Leads) coordinate feeding activities with other Federal agencies, NGOs, and private sector agencies and organizations.³⁷

MC/EA provides resources and technical assistance to SLTT governments before, during, and after a disaster to meet the feeding needs of evacuees. A component of feeding also includes meeting the basic needs of infants, toddlers, children, and people with dietary restrictions and/or culturally appropriate dietary needs.

B. Partner Organizations

MC/EA works with multiple partners in feeding support efforts, including but not limited to: CNCS, USDA, DOD, USACE, American Red Cross, the National VOAD and its member organizations (e.g., Feeding America, the Salvation Army, Southern Baptist Disaster Relief (SBDL), and Greater Good / Rescue Bank).

C. Triggers for Implementation

In the event of a natural or manmade disaster, feeding support services are triggered by an emergency declaration or a major disaster declaration for PA (Category B) with the request of SLTT governments. There is no individual application process required for survivors. However, a major disaster declaration for Individual Assistance is required for the Disaster Supplemental Nutrition Assistance Program (D-SNAP), a program which can be authorized by the USDA upon request.

D. Delivery of Assistance

FEMA MC/EA provides support to both pre-disaster and post-disaster feeding activities. Pre-disaster responsibilities include:

- Providing technical assistance for the development of multi-agency feeding templates, Federal, SLTT government plans, training materials, exercises, and other tools to strengthen and enhance the nation's capacity to support feeding activities;
- Analyzing and incorporating best practices and lessons learned into preparedness activities;
- Developing contracts, PSMAs, agreements, and other mechanisms to provide resources, programs, and services for feeding during disaster response activities;



Tools and Resources

- [National Mass Care Strategy Multi-Agency Feeding Plan Template](#)
- Feeding Support Task Force and Feeding Assessment Team
- FEMA Emergency Support Function (ESF) #6 Support Systems (ESF6-SS), which tracks and supports Geographic Information System (GIS) mapping of shelter locations, and other Federal systems that support feeding activities.

- Expanding national capabilities beyond the traditional MC/EA service providers to meet Federal Interagency Operational Planning-Response metrics;
- Providing technical assistance for the establishment of SLTT government feeding task forces;
- Providing subject matter expertise to internal partners, including Response, Recovery, Logistics and National Preparedness Directorates, PA, Office of Disability Integration and Coordination, and the National Processing Service Center; and
- Providing technical assistance and subject matter expertise to government agencies, NGOs, and the private sector to expand national feeding capability.

Once a disaster is declared, FEMA MC/EA provides post-disaster support, such as:

- Coordinating with other Federal agencies, the affected STT governments, NGOs, and other partners to analyze and validate the need for human and material resources, programs, and services for feeding;
- Providing subject matter expertise/technical assistance in the NRCC, RRCC, FEMA JFO, IOF, STT government EOC, and/or other field settings;
- Assisting the SLTT government in the implementation of a coordinated and integrated feeding mission that meets the disaster-caused needs of evacuees and survivors;
- Providing resource support, including equipment, material, supplies, facilities, and personnel, to support SLTT government jurisdictions and their partners with feeding operations through mission assignments, contracts, and other mechanisms;
- Coordinating with FEMA Logistics to acquire, store, transport, and/or distribute resources to support feeding operations;
- Providing tools and resources to assist the SLTT government jurisdictions and their partners with the implementation of integrated strategies and processes for coordinated feeding operations; and
- Monitoring activity, analyzing data, validating information, and reporting on feeding activities; identifying resource requirements, shortfalls, and limiting factors; providing information to FEMA, other Federal agencies, SLTT governments, NGOs, and private sector partners.



Whole Community

Whole Community is an approach to emergency management that reinforces the fact that FEMA is only one part of our nation's emergency management team; that we must leverage all of the resources of our collective team in preparing for, protecting against, responding to, recovering from, and mitigating all hazards; and that collectively we must meet the needs of the entire community in each of these areas.

Whole community contributors include children; older adults; individuals with disabilities and others with access and functional needs; those from religious, racial, and ethnically diverse backgrounds; people with limited English proficiency; and owners of animals, including household pets and service animals.

This larger collective emergency management team includes not only FEMA and its partners at the Federal level, but also SLTT government partners; non-governmental organizations like faith-based and nonprofit groups and private sector industry; and individuals, families, and communities, who continue to be the nation's most important assets as first responders during a disaster. Both the composition of the community and the individual needs of community members, regardless of age, economics, or accessibility requirements, must be accounted for when planning and implementing disaster strategies.

IV. Distribution of Emergency Supplies Support

A. Description of Assistance

Upon request from an SLTT government, FEMA MC/EA staff works with FEMA and SLTT logistics managers to provide support and ensure emergency supplies needed are identified and coordinated with ESF #6. Such support may include: technical assistance and, if required, resource support through internal logistics and contracted capabilities. FEMA VALs work with state volunteer and donations managers regarding the management and distribution of unsolicited donations. See [Chapter 8](#) for more information.

Under this activity, FEMA MC/EA coordinates with Logistics to organize the targeted acquisition, storage, delivery, and provision of life-sustaining resources, hygiene items, and clean-up items to meet the immediate, basic needs of evacuees and disaster survivors, and their HPSA. Additional support can include transportation, warehousing, equipment, technical assistance, staff, and other mission-critical services.³⁸

Organizations engaged in the distribution of supplies and other relief and assistance activities shall accomplish these activities in an equitable and impartial manner, without discrimination on the grounds of race, color, religion, national origin, sex, age, disability, English proficiency, or economic status.³⁹

There are four categories of emergency supplies:

- Life-sustaining, such as food, water, non-prescription medicine, cooking kits, and supplies for HPSA.
- Comfort, such as hygiene kits (including supplies like toothpaste, towels, washcloths, soaps, and toothbrushes), sleeping bags, tents, cots, and blankets.
- Clean-up, such as shovels, rakes, bleach, gloves, cleaning detergents, buckets, mops, trash bags, chlorine bleach, garden hose/nozzle, and hand sanitizer.
- Other essential supplies, such as first aid kits and other items unique to specific disaster.



Evacuee gathers food and necessities at the Chalmette Recovery Center following devastating Hurricane Katrina.

B. Partner Organizations

MC/EA works with multiple partners in the distribution of emergency supplies, including: other Federal agencies; American Logistics Aid Network (ALAN); Volunteer and Donations Managers at the state and local level; state VALs; the private sector; the National VOAD and its member organizations, such as the American Red Cross, Adventist Community Services, the Salvation Army, Convoy of Hope, Send Relief; and many others.

C. Triggers for Implementation

In the event of a natural or manmade disaster, the distribution of emergency supplies is triggered by an emergency declaration or a major disaster declaration for PA (Category B) at the request of the STT government. There is no individual application process required for survivors.



Tools and Resources

- CUSI includes DME, CMS, hygiene kits, and other relevant information resources, available on the [National Mass Care Strategy](#) website.
- FEMA ESF #6 Support System, which tracks and maps distribution site locations.
- FEMA MC/EA Resource Support tool, which enables users to develop estimates for MC/EA requirements based on multiple variables, quantify available resources that meet requirements, and identify shortfalls.
- National Voluntary Organizations Active in Disaster, which provides facilities, equipment, supplies, and personnel. See the Multi-Agency Distribution of Emergency Supplies Plan Template for a list of National VOAD organizations involved in the distribution of emergency supplies.
- ESF #6 Support Contract, which provides for facilities, equipment, supplies, and personnel.
- Corporation for National and Community Service, which provides personnel.

D. Delivery of Assistance

FEMA MC/EA provides support to both pre-disaster and post-disaster emergency supplies distribution efforts. Pre-disaster responsibilities include:

- Providing technical assistance in the development and maintenance of: a multi-agency distribution of emergency supplies planning template; Federal and SLTT government plans; training materials; and other tools that strengthen and enhance the nation's capacity to coordinate and distribute emergency supplies;
- Incorporating best practices and lessons learned for the distribution of emergency supplies;
- Developing contracts, PSMA's, MOA's, and Memoranda of Understanding (MOU's), and other mechanisms to acquire, store, and distribute emergency supplies during a disaster response;
- Coordinating with outside partners, including other Federal agencies; SLTT government entities; NGOs; and public and private sectors to develop and maintain integrated processes and mechanisms to increase SLTT government distribution of emergency supplies resource capabilities; and
- Providing subject matter expertise to internal FEMA partners, including the Response, Recovery, Logistics and National Preparedness Directorates, PA, the Office of Disability Integration and Coordination, and the National Processing Service Centers.

Once a disaster has been declared, MC/EA coordinates with state government and NGO partners to analyze anticipated resource shortfalls to provide commodities to impacted areas. As a last resort, MC/EA has the capability to utilize contracts to support resource shortfalls. NGOs provide support, which includes:

- Coordinating with internal and external partners, monitoring activity, analyzing data and validating information to provide support to the states for services and human and material resources;
- Providing subject matter expertise/technical assistance in the NRCC, RRCC, FEMA JFO, IOF, STT EOC, and/or other field settings;
- Assisting jurisdictions in the implementation of a coordinated and integrated whole community distribution system that meets the disaster-caused needs of evacuees and survivors;
- Providing resource support, including equipment, material, supplies, facilities, and personnel, to support the SLTT distribution operation through mission assignments, contracts, and other means;
- Monitoring activity, analyzing data, and validating information on and requests for resource support;
- Identifying resource requirements, shortfalls, and limiting factors; and
- Communicating information to partners.

V. Disability, Access, and Functional Needs Support

A. Description of Assistance

FEMA MC/EA coordinates with and supports SLTT governments in the provision of services and resources to people with disabilities and others with access and functional needs. The MC/EA Section ensures that the needs of evacuees and disaster survivors with access and functional needs are met in congregate and non-congregate facilities, including general population shelters, embarkation and disembarkation sites, reception centers, and other settings, through the coordination, procurement, transportation, and provision of resources. These services should be integrated into all MC/EA activities.⁴⁰

B. Partner Organizations

MC/EA works with multiple partners in efforts supporting individuals with disabilities and others with access and functional needs, including, but not limited to: the HHS Preparedness and Response (Personnel/Disaster Medical Assistance Teams/Emergency Prescription Assistance Program), VA, the American Red Cross, the National Council on Independent Living (NCIL), the National Disability Rights Network (NDRN), Pass It On Center, Friends of Disabled Adults and Children (FODAC), Partnership of Inclusive Disaster Strategies and Portlight Inclusive Disaster Strategies, the Salvation Army, DOD, and others.

C. Triggers for Implementation

In the event of a natural or manmade disaster, disability and access and functional needs support is triggered by an emergency declaration or a Presidential disaster declaration for PA (Category B). There is no individual application process required for survivors.

D. Delivery of Assistance

FEMA MC/EA provides support to individuals with disabilities and others with access and functional needs in both the pre-disaster and post-disaster phases. Pre-disaster responsibilities include:

- Developing plans, templates, guidance, training courses, and tools for MC/EA providers at the SLTT government and NGO levels to ensure access and functional needs support services are integrated into operational plans;
- Developing contracting requirements, pre-scripted mission assignments, interagency agreements, and other mechanisms to provide resources and services to people with disabilities and others with access and functional needs during disaster response activities; and
- Coordinating with FEMA's Office of Disability Integration and Coordination and Office of Equal Rights, the American Red Cross, HHS, and other agencies and organizations to identify and develop strategies and processes to expand support to people with disabilities and others with access and functional needs.

Once a disaster has been declared, FEMA MC/EA provides post-disaster support, such as:

- Coordinating with Federal agencies, NGOs, and other partners to support the state in monitoring, analyzing, and validating the need for human and material resources, programs, and services;
- Acquiring and deploying DME, CMS, assistive technology, accessible hygienic stations, portable ramps, enhanced cots, and bariatric equipment and provide accessible communication support (i.e., American Sign Language [ASL] interpreters, Text Telephone [TTY], and Section 508 compliant communication);
- Activating contracts under IASC for Personal Assistance Services (PAS);
- Retrofit facilities to meet ADA and other accessibility requirements;
- Coordinating with other Federal agencies and non-governmental veterinary and animal welfare organizations to support life-sustaining resources for service and assistance animals, including food, hydration, and veterinary medical care and treatment;
- Providing subject matter expertise/technical assistance in the NRCC, RRCC, FEMA JFO, IOF, STT EOC, and/or other field settings; and
- Providing subject matter expertise to the Multi-agency Sheltering Transition Team, which is responsible for identifying resources for survivors to maintain independence in congregate and non-congregate settings.

E. Personal Assistance Services

FEMA MC/EA, upon request from the STT government, contracts with PAS providers to augment the ability of SLTT governments to support individuals with disabilities in maintaining their health, safety, and independence in congregate and non-congregate shelter facilities, in the most integrated setting, to meet their needs during a Presidentially-declared disaster event, as required under the Americans with Disabilities Act or other applicable federal civil rights laws.

PAS may be required to support people whose usual means of assistance are not available due to circumstances associated with a disaster. PAS workers are sometimes referred to as home health aides, Certified Nursing Assistants, or caregivers. The services are defined as formal and informal services provided by paid personal attendants, friends, family members, and/or volunteers that enable individuals with disabilities to maintain their routine level of independence while in an emergency shelter. FEMA may provide PAS support to meet assistance with the activities of daily living and other identified care requirements upon request of the impacted SLTT government jurisdiction.



Personal Assistance Services (PAS)

PAS augments disaster-affected jurisdictions in their ability to support disaster survivors with disabilities to maintain their health, safety, and independence.

FEMA MC/EA provides subject matter expertise to internal and external partners, including the Office of Response and Recovery, Office of Disability Integration and Coordination, American Red Cross, FEMA Regions, and other agencies. They coordinate with FEMA acquisitions, and Contract Management Section to develop, maintain, manage, and implement contracts. They also maintain a list of Frequently Asked Questions (FAQ) to ensure the SLTT government and NGOs have access to current information regarding PAS program requirements.

Once a disaster has been declared, FEMA MC/EA coordinates with other Federal agencies, the Office of Disability Integration and Coordination, FEMA Logistics, NGOs, and other partners to monitor activity, analyze data, validate information and provide support to the states on the need for PAS. This includes potentially deploying subject matter expertise and technical assistance in the NRCC, RRCC, FEMA JFO, SLTT government EOCs, and other field offices in order to acquire, deploy, and provide PAS as requested by the SLTT government.



Tools and Resources

- FEMA: *Guidance on Planning for the Integration of Functional Needs Support Services in General Population Shelters*

In order to provide monitoring, analysis, and validation support to an STT government on functional needs support activities, FEMA MC/EA identifies resource requirements, shortfalls, and limiting factors and exchange information with FEMA, other Federal agencies, SLTT governments, and NGO and Private Sector agencies and organizations. FEMA MC/EA also participates in the task forces and work groups staffed by individuals from multiple agencies and organizations and created to identify shortfalls and provide the support needed to maintain independence during congregate care.

VI. Reunification Services

A. Description of Assistance

Reunification Services is one of the MC/EA activities where FEMA has a statutorily mandated role in providing services directly to disaster survivors to facilitate the reunification of unaccompanied minors with their custodial parents/legal guardians, as well as the voluntary reunification of adults with their families, during declared emergencies or major disasters.⁴¹

FEMA works to coordinate this statutory requirement directly with the impacted SLTT jurisdiction(s), and collaborates with whole community partners to develop procedures, identify best practices, and provide resources to strengthen reunification services. MC/EA facilitates partner agreements and identifies and develops new resources and tools, including training and exercises, in support of SLTT governmental reunification planning and operations. FEMA also coordinates deployment of national reunification resources—both human and material—to support state-, territory-, or tribe-led reunification task forces as well as field operations.⁴²

B. Partner Organizations

MC/EA works with multiple partners in reunification efforts, including: the National Center for Missing and Exploited Children, the CNCS, the Department of Justice (DOJ), HHS, and the American Red Cross.

C. Triggers for Implementation

In the event of a natural or manmade disaster, reunification services are triggered by an emergency declaration or a major disaster declaration for PA (Category B). Once an event is declared as an emergency or major disaster, and emergency protective measures (such as Reunification) are being performed, an individual only has to be affected by the declared incident to qualify for Reunification Assistance; there is no additional application process required for the individual or household.

D. Delivery of Assistance

FEMA MC/EA provides support to both pre-disaster and post-disaster reunification activities.

Pre-disaster responsibilities include:

- Providing technical assistance for the development of Federal and STT government reunification plans, training materials, exercises, and other tools to strengthen and enhance the nation's capacity to support reunification activities;
- Analyzing and incorporating best practices and lessons learned into preparedness activities, including anticipating and establishing practical approaches to address the communication access needs of people who are deaf or hard of hearing, people without speech, people with cognitive or intellectual disabilities, and people who speak languages other than English;
- Developing contracts, pre-scripted mission assignments, agreements, and other mechanisms to provide resources, programs, and services for reunification during disaster response activities for FEMA to meet our statutory obligations;
- Providing technical assistance for the establishment of STT government reunification task forces;

- Providing subject matter expertise to internal partners, including Response, Recovery, Logistics and National Preparedness Directorates; PA; Office of Disability Integration and Coordination; External Affairs; Office of the Senior Law Enforcement Advisor; and the National Processing Service Centers;
- Providing technical assistance and subject matter expertise to and coordinating planning efforts with government agencies, NGOs, and the private sector to expand national reunification capability;
- Identifying communication mechanisms, which include but are not limited to, new reunification systems, current and emerging social media tools and communication technologies, and private/public communications equipment;
- Developing agreements and procedures to utilize or coordinate the use of these communication mechanisms; and
- Incorporating these resources into plans and procedures in order to provide access for disaster survivors to a wide range of communications methods in a timely manner.

Once a disaster has been declared, FEMA MC/EA provides post-disaster support such as:

- Coordinating with other Federal agencies; STT governments; NGOs; and other partners to monitor, analyze, validate, and provide human and material resource support, programs, and services for reunification;
- Providing subject matter expertise/technical assistance in the NRCC, RRCC, FEMA JFO, IOF, STT government EOC, and/or other field settings;
- Providing staff and resources to support field operations, STT-led reunification task forces, and related task forces, such as a Children and Youth Task Force;
- Assisting the STT government in the implementation of coordinated and integrated reunification services system for evacuees and survivors, including evacuees and survivors who are deaf or hard of hearing, evacuees and survivor without speech, evacuees and survivor with cognitive or intellectual disabilities, and evacuees and survivors who speak languages other than English;
- Providing resources, including equipment, material, supplies, facilities, and personnel, to support STT government operations through mission assignments, contracts, and other mechanisms;
- Providing tools and resources to assist the STT government in the implementation of integrated strategies and processes for coordinated reunification operations;
- Monitoring activity, analyzing data, and validating information on reunification activities;
- Identifying resource requirements, shortfalls, and limiting factors;
- Coordinating public messaging with reunification partners and FEMA External Affairs;
- Activating resources of the National Center for Missing and Exploited Children, via the current procurement process, to stand up the National Emergency Child Locator Center (NECLC) and deploy Team Adam (a staff resource to assist with identification and reunification of children) upon request from the declared STT government; and
- Providing support to law enforcement missing persons operations and agencies tasked with child reunification during response and transition to recovery as needed and requested.

E. National Emergency Child Locator Center

FEMA also utilizes NECLC, which is operated out of the National Center for Missing and Exploited Children. In collaboration with National Center for Missing and Exploited Children, FEMA supports SLTT governments and law enforcement agencies in the tracking, locating, and reunification of children who have become separated from their parents or guardians as a result of a Presidentially-declared disaster.



**National Emergency
Child Locator Center (NECLC)**

Phone: 800-843-5678

Website: <http://www.missingkids.com/home>

VII. Household Pets, Service Animals, and Assistance Animals

A. Description of Assistance

FEMA MC/EA, in consultation with FEMA Regions and SLTT government jurisdictions provides coordination and support for the rescue, transportation, shelter, reunification, essential needs, and care of HPSA during preparedness and response and recovery operations to ensure their safety and well-being of owners and their HPSA. Upon request from the SLTT government jurisdictions, FEMA MC/EA supports HPSA activities with the provision of technical assistance and resource support through Federal, SLTT government, NGO, and private sector partners.⁴³ FEMA's engagement on HPSA issues falls under the relevant statutory requirements of the Robert T. Stafford Disaster Relief and Recovery Act and under other statutory and/or regulatory requirements related to service and assistance animals (e.g., the Americans with Disabilities Act, Fair Housing Act).

B. Partner Organizations

MC/EA works with multiple partners in HPSA support efforts, including: DOD, USDA, and HHS Assistant Secretary for Preparedness and Response (ASPR) National Veterinary Response Teams; the American Red Cross, the National Alliance of State Animal and Agricultural Emergency Programs (NASAAEP), the NARSC, GreaterGood.org, and National VOAD.



Flood survivor holds his cat inside of his gutted residence in Denham Springs; the home was damaged by severe flooding in Louisiana during 2016.

C. Triggers for Implementation

In the event of a natural or manmade disaster, HPSA support services are triggered by an emergency declaration or a major disaster declaration for PA (Category B) with a request from STT governments. There is no individual application process required for survivors.

D. Delivery of Assistance

FEMA MC/EA provides support for HPSA in both the pre-disaster and response phases. Pre-disaster responsibilities include:

- Providing technical assistance for the development of multi-agency HPSA templates, Federal response and recovery), and SLTT government emergency operations plans (EOPs), training materials, and other tools to strengthen and enhance the nation's capacity to support HPSA disaster activities;
- Analyzing and incorporating best practices and lessons learned into preparedness activities;
- Developing methods of procurement, pre-scripted mission assignments, other agreements and mechanisms to provide resources, coordinating, and supporting programs and services for owners and their HPSA during disaster response activities;
- Coordinating with government agencies, NGOs, and the private sector to develop integrated processes and mechanisms to augment national, regional, state, and local HPSA capabilities; and
- Providing subject matter expertise to internal FEMA partners, including Response, Recovery, Logistics and National Preparedness Directorates, PA, Office of Disability Integration and Coordination, and Office of External Affairs.

Once a disaster has been declared, FEMA MC/EA provides post-disaster support, such as:

- Coordinating with other Federal agencies, STT governments (related to Stafford Act authorities), FEMA Logistics, NGOs, and other partners to analyze and validate the need for support with human and material resources, programs, and services;
- Providing subject matter expertise/technical assistance in the NRCC, RRCC, FEMA JFO, IOF, STT government EOCs, and/or other field settings;
- Assisting the STT government in the implementation of coordinated and integrated HPSA response and recovery activities that meet the disaster-caused needs of evacuees, survivors, and their HPSA;
- Providing resource support, including equipment, materials, supplies, facilities, veterinary services, specialized transportation, and personnel to support the rescue, transportation, sheltering, and care of HPSA through mission assignments, contracts, and other mechanisms;
- Collecting, analyzing, validating, and reporting information on HPSA activities; identifying resource requirements, shortfalls, and limiting factors; and providing information to FEMA, other Federal agencies, SLTT governments, NGOs, and private sector partners; and
- Coordinating with other Federal agencies and NGOs at the NRCC/RRCC/EOC/IOF on transportation coordination issues, logistics, response, and evacuation issues to:
 - Encourage the inclusion of HPSA food and supplies, mobile feeding, and distribution operations;
 - Encourage the inclusion of HPSA included in the reunification plans and activities; and
 - Monitor information on the status of HPSA sheltering activities to update situational awareness.



Tools and Resources

- Public Assistance Program and Policy Guide (PAPPG)
- Multi-agency coordination support and/or multi-agency support task force, and Federal and state software systems that support HPSA activities
- FEMA ESF #6 Support System, which manages data and supports GIS products related to emergency household pet shelter locations
- FEMA MC/EA Resource Management Tool

VIII. Mass Evacuee Support

A. Description of Assistance

FEMA MC/EA may support disaster-affected and host-state governments by providing life-sustaining services and resources to disaster survivors/evacuees and their HPSA during mass evacuation incidents. MC/EA provides pre-incident support in the form of technical assistance, coordination and communication, and identified resources. At the time of an incident response, FEMA MC/EA staff will work in collaboration with the STT government to determine if Mass Evacuee Support is required or if it will conduct such activities at the direction of the President.⁴⁴

B. Partner Organizations

MC/EA works with multiple partners in mass evacuee support efforts, including but not limited to: the American Red Cross, National VOAD, USDA, and DOD.

C. Triggers for Implementation

In the event of a natural or manmade disaster, mass evacuee support services are triggered by an emergency declaration or major disaster declaration for PA (Category B), and a request from the SLTT government. There is no individual application process required for survivors.

D. Delivery of Assistance

FEMA MC/EA provides support to both pre-disaster and post-disaster mass evacuee efforts. Pre-disaster responsibilities include:

- Providing technical assistance for the development of multi-agency mass evacuee support templates; Federal and SLTT government plans; training materials; and other tools to strengthen and enhance the nation's capacity to support transportation-assisted evacuees;
- Analyzing and incorporating best practices and lessons learned into preparedness activities for evacuee support, including accessible and multilingual messaging in plain language or using pictograms and identifying accessible transportation assets for older adults and people with mobility disabilities;
- Developing contracts, pre-scripted mission assignments, agreements, and other mechanisms to provide resources, programs, and services to support mass evacuees;
- Coordinating with government agencies, NGOs, and the private sector to develop integrated processes and mechanisms to augment national, regional, SLTT government capabilities for mass evacuee support;
- Supporting implementation of Host State Agreements (a state agrees to provide evacuation and/or sheltering support to individuals from the Presidentially-declared impact state);
- Providing training and facilitating exercises with other Federal, SLTT governments and NGO partners; and
- Providing subject matter expertise to internal partners, including, Response, Recovery, Logistics and National Preparedness Directorates, PA, Office of Disability Integration and Coordination, and the National Processing Service Center.

Once a disaster has been declared, FEMA MC/EA provides post-disaster support, such as:

- Coordinating with other Federal agencies, declared and host SLTT governments, FEMA Logistics, NGOs, and other partners to monitor, analyze, validate the need for, and provide support to SLTT governments for human and material resources, programs, and services;
- Providing subject matter expertise/technical assistance in the NRCC, RRCC, FEMA JFO, IOF, STT government EOC, and/or other field settings;
- Providing resources, including equipment, material, supplies, facilities, and personnel to support mass evacuees through mission assignments, contracts, and other mechanisms;
- Identifying resource requirements, shortfalls, and limiting factors, and providing information to FEMA, other Federal agencies, SLTT governments, NGOs, and private sector partners.

IX. Transitional Sheltering Assistance

A. Description of Assistance

The guidelines for TSA are currently under review in order to incorporate changes resulting from the 2017 Hurricane Season. Due to the publication date of the IAPPG, the updated guidelines could not be included. The new guidelines will be published as soon as they are available. At this time, the operation of TSA will be determined on a disaster-specific basis.

TSA is a short-term non-congregate sheltering form of assistance for displaced disaster survivors taking refuge in emergency shelter locations other than their pre-disaster primary residence. The intent of TSA is to provide temporary sheltering for survivors as they transition from emergency shelters to temporary or permanent housing solutions.

FEMA may provide TSA at the request of a declared STT government. When authorized, TSA provides assistance under Sections 403 or 502 of the Stafford Act, as amended, and is implemented under Section 408.⁴⁵ TSA does not count toward the applicants' financial Housing Assistance or Other Needs Assistance maximum award. TSA is funded under Section 403 of the Stafford Act and is subject to PA regulations on cost-share. For more information on PA, see *Public Assistance Program and Guide, FP 104-009-2*.

Additional program guidance and implementation information and tools will be made available to non-Federal entities by FEMA MC/EA through interim and final policy guidance.

X. Rapid Temporary Repair (Operation Blue Roof) Program

A. Description of Assistance

The Operation Blue Roof Program provides a free temporary roof for residential structures, schools, daycares, and some publicly-owned facilities. These temporary roofs provide short-term relief until the owner can make permanent repairs. They also prevent additional damage from occurring to the building and its contents. Plastic covering and tarps are temporary fixes designed to provide protection from the elements until the homeowner can make permanent repairs with a qualified professional. The authority governing the Rapid Temporary Repair program is the Stafford Act Section 403.

B. Partner Organizations

USACE staffs and operates Right of Entry (ROE) centers for disaster-affected areas. ROE centers are used to collect the ROE form from homeowners

C. Eligibility Considerations

In order for a structure to qualify for Operation Blue Roof, damage to the roof must be less than 50%, and the area to be covered must be structurally sound for a crew to work on. Additionally, homeowners must complete a ROE form to allow government and contractor employees on their property.



Tools and Resources

ROE centers for affected areas are staffed by USACE employees.

To contact the nearest center, call 888-766-3258.

D. Delivery of Assistance

Once eligibility is determined, homeowners must complete a ROE form before government and contractor employees will begin installing a blue roof. Homeowners may also cover their roofs with free tarps provided by FEMA and issued through their local governments. Survivors should contact their local officials and/or monitor social media for updates on where to pick up these tarps.

XI. National Mass Care Exercise

A. Description of Exercise

The goal of the NMCE is to support the development of an STT government's mass care capacity and capabilities through partnership, coordination, and collaboration. The NMCE can serve to validate an STT government's mass care services delivery or support plan. The NMCE should be adapted to suit the unique needs of the STT government hosting the exercise. This may include incorporating mass care as a main focus of a larger, existing state exercise or by developing a standalone mass care exercise. The exercises are valuable for enhancing the nation's Mass Care Services core capability by utilizing a Whole Community Emergency Management approach to ensure that the needs of disaster survivors are met and contributing lessons learned and best practices.

B. Application Process

States, territories, and tribes interested in applying to host the National Mass Care Exercise are encouraged to contact their FEMA Regional MC/EA Point of Contact for detailed information. Host entities are selected in the last quarter of the calendar year and typically conduct the exercise two to three years after selection.

C. Implementation of Exercise

FEMA Headquarters MC/EA will be designated as the lead to coordinate or directly provide additional support to the FEMA Region, as requested. The MC/EA Headquarters Lead is responsible for not only supporting the Region/Host State but also in ensuring that national MC/EA concepts and capabilities are continuously being tested and that national best practices are captured and updated. The Headquarters MC/EA lead can also provide access to past exercise expertise and tools. The FEMA MC/EA Section may also provide additional support through the sponsorship of invitational travel for a limited number of additional state Mass Care Coordinators (or their equivalent) from across the country, generally including the state Mass Care Coordinator for the following year's NMCE.



Tools and Resources

- National Mass Care Strategy
- Mass Care Multi-Agency Planning Templates
- Applicant/Host Toolkit
- After Action Reports of Past Exercises
- FEMA Regional Mass Care/Emergency Assistance Points of Contact (POCs)
- FEMA Regional Exercise Officers
- National Preparedness Goal (NPG)

Chapter 3: Individuals and Households Program

I. Individuals and Households Program Overview

Individuals and Households Program (IHP) assistance provides financial assistance and direct services to eligible individuals and households who have uninsured or underinsured necessary expenses and serious needs. IHP assistance is not a substitute for insurance and cannot compensate for all losses caused by a disaster; it is intended to meet basic needs and supplement disaster recovery efforts.

IHP assistance is not considered income⁴⁶ or a resource when determining eligibility for welfare, income assistance, or income-tested benefit programs that the Federal government funds, such as Social Security benefits or disability income.⁴⁷ IHP assistance is also exempt from garnishment or seizure, but this exception does not apply to FEMA recovering assistance received in error or fraud.⁴⁸

A. Period of IHP Assistance

IHP assistance is limited to 18 months following the date of the disaster declaration.⁴⁹ The period of assistance begins at the date of the Presidential disaster declaration and not the date on which the disaster is designated for Individual Assistance (IA).⁵⁰ The President may extend the period of assistance due to extraordinary circumstances if an extension would be in the public interest.

Through the delegation of authority, the Assistant Administrator (AA) for Recovery may, at the written request of an STT government, extend the period of assistance.⁵¹ Should extraordinary circumstances exist, the AA for Recovery may extend the period of assistance for Direct Temporary Housing Assistance (See Chapter 3, V.C.4) or financial assistance. The affected STT government should request an extension in writing at least 90 days before the end of the current period of assistance.

B. Amount of IHP Assistance

The amount of financial assistance an individual or household may receive under IHP is limited. Financial Housing Assistance and Other Needs Assistance (ONA) have independent and equal financial maximums. FEMA adjusts these maximum awards each fiscal year based on the Department of Labor Consumer Price Index.⁵² FEMA informs the public of changes to the financial Housing Assistance and ONA maximums each year by publishing a notice in the Federal Register.

As shown in *Figure 4*, the financial Housing Assistance⁵³ maximum applies to Home Repair Assistance and Home Replacement Assistance. Temporary Housing Assistance, including Lodging Expense Reimbursement, Rental Assistance, and Continued Temporary Housing Assistance are not counted toward the financial Housing Assistance maximum award.

Disaster-caused losses to accessibility-related real and personal property for qualified applicants with a disability or other access and functional need are not subject to a financial assistance maximum.

- The U.S. Small Business Administration disaster loan referral limitations still apply.
- This applies to accessibility items currently awarded under Home Repair Assistance and Personal Property Assistance.

Eligible individuals or households receiving IHP assistance may not necessarily be awarded the maximum amount of financial assistance for their disaster-caused losses.

Figure 4: Types of Financial Assistance and Financial Maximum Awards		
IHP Assistance Maximum	Type of Assistance	Maximum
Financial Housing Assistance Maximum	Home Repair Assistance	Adjusted annually by Consumer Price Index
	Home Replacement Assistance	
Financial Other Needs Assistance Maximum	Personal Property Assistance	Adjusted annually by Consumer Price Index
	Transportation Assistance	
	Moving and Storage Assistance	
	Medical and Dental Assistance	
	Funeral Assistance	
	Child Care Assistance	
	Assistance for Miscellaneous Items	
	Critical Needs Assistance	
	Clean and Removal Assistance	
No Maximum Applicable	Group Flood Insurance Policy	Award amount based on receipts, Fair Market Rent rates, or line item amounts established by FEMA
	Lodging Expense Reimbursement	
	Rental Assistance	
	Continued Temporary Housing Assistance	
	Home Repair Assistance accessibility items	
Personal Property accessibility items		

Although minimal damage may cause some inconvenience, it is expected that individuals or households will address those losses without Federal assistance. Therefore, FEMA will only provide assistance when the total initial IHP award amount is a minimum of \$50.⁵⁴ There is no minimum amount for subsequent awards.

Other Federal programs and voluntary organizations may provide additional financial assistance for unmet needs.

C. Types of IHP Assistance

There are two categories of IHP assistance: Housing Assistance and Other Needs Assistance (ONA).

1. Housing Assistance

Individuals and households may receive more than one type of Housing Assistance, including a combination of financial assistance and direct services (see *Figure 5*).⁵⁵

FEMA determines the appropriate types of Housing Assistance for which an individual or household may be eligible based on disaster-caused losses, access to life-sustaining services, cost-effectiveness, and other factors.⁵⁶

FEMA provides financial Housing Assistance through funds paid directly to eligible individuals and households. Financial Housing Assistance may include the following types of assistance:

- **Lodging Expense Reimbursement (LER):** Financial assistance to reimburse for hotels, motels, or other short-term lodging while an applicant is displaced from their primary residence.
- **Rental Assistance:** Financial assistance to rent alternate housing⁵⁷ accommodations while an applicant is displaced from their primary residence.⁵⁸
- **Home Repair Assistance:** Financial assistance to repair an owner-occupied primary residence, utilities, and residential infrastructure, including privately-owned access routes (i.e., driveways, roads, or bridges), to a safe and sanitary living or functioning condition.⁵⁹
- **Home Replacement Assistance:** Financial assistance to help replace an owner-occupied primary residence when the residence is destroyed.⁶⁰



IHP Assistance Scenario

An applicant's FEMA inspection recorded \$900 in real property damage and \$25 in personal property damage. The applicant's insurance settlement totaled \$875 for real property, which left an unmet need of \$25 in real property and \$25 in personal property. In this scenario, the applicant is eligible for the total IHP award of \$50, which is a combined total of Home Repair Assistance and Personal Property Assistance.



Primary Residence

Primary residence refers to:

- The home where the applicant normally lives during the major portion of the calendar year, **or**
- The home that is required because of proximity to employment, including agricultural activities that provide 50% of the household's income.

FEMA may provide Direct Housing Assistance⁶¹ when applicants are unable to use Rental Assistance due to a lack of available housing resources. Direct Housing Assistance does not count toward the financial Housing Assistance maximum award and may include:

- **Multi-Family Lease and Repair (MLR):** Allows FEMA to enter into lease agreements with owners of multi-family rental property located within or near declared areas to make repairs or improvements that provide temporary housing to applicants.⁶²
- **Transportable Temporary Housing Units (TTHUs):** A readily fabricated dwelling (i.e., a Recreational Vehicle [RV] or a Manufactured Housing Unit [MHU]), purchased or leased by FEMA and provided to eligible applicants for use as temporary housing for a limited period of time.
- **Direct Lease:** Existing ready-for-occupancy residential property leased for eligible applicants and, if necessary, modified or improved to provide a reasonable accommodation for an eligible applicant with a disability, for use as temporary housing.
- **Permanent Housing Construction (PHC):** Home repair and/or construction services provided in insular areas outside the continental U.S. and in other locations where no alternative housing resources are available; and where types of housing assistance FEMA normally provides, such as Rental Assistance or other forms of direct assistance, are unavailable, infeasible, or not cost-effective.⁶³

Figure 5: Housing Assistance	
Financial Assistance	<ul style="list-style-type: none"> • Lodging Expense Reimbursement • Rental Assistance • Repair Assistance • Replacement Assistance
Direct Assistance	<ul style="list-style-type: none"> • Multi-Family Lease and Repair • Transportable Temporary Housing Units • Direct Lease • Permanent Housing Construction

2. Other Needs Assistance

Applicants may receive financial assistance for other disaster-caused expenses and serious needs.⁶⁴ The types of ONA are divided into two categories that are either dependent or non-dependent on the applicant's ability to secure a U.S. Small Business Administration (SBA) disaster loan. The SBA may provide low-interest, long-term loans to help applicants with transportation losses, as well as repair/replacement funds for real and personal property damage caused by the disaster.

Only applicants who do not qualify for a loan from the SBA may be eligible for assistance for the SBA-dependent category. SBA-dependent ONA includes Personal Property Assistance, Transportation Assistance, and Group Flood Insurance Policy (GFIP). Non-SBA-dependent types of ONA may be awarded regardless of the applicant's SBA status and may include Funeral Assistance, Medical and Dental Assistance, Child Care Assistance, Assistance for Miscellaneous Items, Moving and Storage Assistance, Critical Needs Assistance, and Clean and Removal Assistance.



FEMA and SBA conduct inspections along the Yukon River for applicants residing in fishing camps who were affected by severe flooding in Fort Yukon, Alaska.

II. Individuals and Households Program Eligibility

While each type of IHP assistance has specific conditions of eligibility and documentation requirements, this chapter describes the basic conditions of eligibility that apply to all FEMA IHP assistance. Specific situations and living arrangements that require clarification are also addressed. This chapter also provides information on the appeal process for applicants who disagree with FEMA’s eligibility determination.

A. General IHP Eligibility

These general conditions must be met for an applicant to be eligible to receive IHP assistance:

- The applicant must be a U.S. citizen, non-citizen national, or qualified alien.
- FEMA must be able to verify the applicant's identity.⁶⁵
- The applicant’s insurance, or other forms of disaster assistance received, cannot meet their disaster-caused needs.⁶⁶
- The applicant’s necessary expenses and serious needs are directly caused by a declared disaster.⁶⁷

The process FEMA uses to verify that necessary expenses and serious needs are directly caused by a declared disaster is described in [Chapter 3, III](#).

In order to receive some forms of Housing Assistance and ONA, applicants must also satisfy occupancy and ownership requirements.

The estate of a deceased applicant is not eligible for IHP assistance. However, a surviving pre-disaster resident of the household may receive assistance if they meet all IHP eligibility criteria.

1. U.S. Citizenship

Only U.S. citizens, non-citizen nationals, or qualified aliens may be eligible for IHP assistance.

During the disaster assistance registration process or on a *Declaration and Release form (FEMA Form 009-0-3)*, applicants self-certify their citizenship status and declare, under penalty of perjury, they fit one of the statuses indicated in *Figure 6*.



Welfare Reform Act

Title IV of the Personal Responsibility and Work Opportunity Reconciliation Act of 1996, commonly known as the Welfare Reform Act, provides that aliens who are not qualified aliens are not eligible for Federal public benefits.

Federal public benefits include any retirement, welfare, health disability, public or assisted housing, post-secondary education, food assistance, unemployment benefits, or any similar benefits for which payments or assistance are provided to an individual, household, or family eligibility unit by an agency of the U.S. or by appropriated funds of the U.S.

Figure 6: U.S. Citizenship and Resident Aliens	
Status	Definitions
U.S. Citizen	A person born in one of the 50 United States, the District of Columbia, Puerto Rico, Guam, the U.S. Virgin Islands, or the Northern Mariana Islands; a person born outside of the U.S. to at least one U.S. parent; or naturalized citizen.
Non-Citizen National	A person born in an outlying possession of the U.S. (e.g., American Samoa or Swain’s Island) on or after the date the U.S. acquired the possession, or a person whose parents are U.S. non-citizen nationals. All U.S. citizens are U.S. nationals; however, not every U.S. national is a U.S. citizen.
Qualified Alien	<ul style="list-style-type: none"> • Legal permanent resident ("green card" holder) • An asylee, refugee, or an alien whose deportation is being withheld • Alien paroled into the U.S. for at least one year • Alien granted conditional entry (per law in effect prior to April 1, 1980) • Cuban/Haitian entrant • Aliens in the U.S. who have been abused, subject to battery or extreme cruelty by a spouse or other family/ household member, or have been a victim of a severe form of human trafficking • Aliens whose children have been abused and alien children whose parent has been abused who fit certain criteria

If an applicant does not meet the criteria identified in *Figure 6*, the household may still apply for and be considered for IHP assistance if:

- Another adult household member meets the eligibility criteria and certifies their citizenship status during the registration process or signs the *Declaration and Release* form; or
- The parent or guardian of a minor child who is a U.S. citizen, non-citizen national, or a qualified alien applies for assistance on behalf of the child, as long as they live in the same household. The parent or legal guardian must register as the co-applicant, and the minor child must be under age 18 at the time the disaster occurred.

There are several categories of aliens lawfully present in the U.S. who are not eligible for IHP assistance. These include, but are not limited to:

- Temporary tourist visa holders
- Foreign students
- Temporary work visa holders
- Habitual residents such as citizens of the Federated States of Micronesia and the Republic of the Marshall Islands

Regardless of citizenship status, disaster survivors may be eligible for the following programs:

- [Chapter 2: Mass Care/Emergency Assistance](#) (search and rescue, medical care, shelter, food, and water, and reducing threats to life, property, and public health or safety)
- [Chapter 5: Crisis Counseling Assistance and Training Program \(CCP\)](#)
- [Chapter 4: Disaster Case Management \(DCM\)](#)
- [Chapter 6: Disaster Legal Services \(DLS\)](#)
- Disaster Food Stamps (*Disaster Supplemental Nutrition Assistance Program, or D-SNAP*), which is administered by the U.S. Department of Agriculture; the STT government can request the Federal government to initiate D-SNAP only after a Presidential disaster declaration approving Individual Assistance.

2. Identity Verification

FEMA must be able to verify an applicant's identity with a valid Social Security Number (SSN) before considering their eligibility for disaster assistance. By verifying identity, FEMA prevents fraud and ensures applicants receive the disaster assistance intended for them.⁶⁸

FEMA typically verifies an applicant's identity at the time of registration:

- Through an automated public records search; and
- Through a series of questions associated with the applicant's credit file or public records.

Applicants who do not successfully respond to the series of questions will not be eligible for expedited forms of assistance prior to receiving an inspection or submitting identity verification documents.

When FEMA is unable to verify an applicant's identity through the automated public records search or the applicant answers identity-verifying questions incorrectly, the applicant may be asked to submit a copy of one of the documents described in *Figure 7*.

Figure 7: Acceptable Documentation to Verify Identity	
Documentation to verify name/SSN:	<ul style="list-style-type: none"> • Documentation from the Social Security Administration (SSA), or other Federal entity, containing full or last four digits of SSN • Social Security card if accompanied by Federal or state-issued identification • Employer’s payroll document containing full or last four digits of the SSN • Military identification • Proof of name change: <ul style="list-style-type: none"> ○ Name change court order ○ Marriage, civil union, or domestic partnership certificate ○ Divorce or annulment decree ○ Certificate of citizenship or naturalization ○ U.S. Tribal government document ○ U.S. amended/corrected birth certificate ○ If the applicant still fails identity verification using their previous name, the applicant will be required to submit one of the other forms of acceptable identity verification • U.S. passport • On a case-by-case basis, FEMA may allow applicants residing in U.S. territories to submit specific identity verification documents, such as voter registration cards, etc.
Documentation - applying for assistance on behalf of a minor child:	<ul style="list-style-type: none"> • Any of the documents listed above, if in the child’s name • Child’s birth certificate and a copy of the child’s Social Security card or documentation from the SSA, or other Federal entity, containing the full or last four digits of the child’s SSN

FEMA does not accept the following documents as proof of an applicant’s identity:

- Internal Revenue Service forms (IRS)
- Notarized statements or affidavits from applicants or any third parties
- Applications for a marriage license or assistance from a Federal entity

3. Insurance

FEMA provides IHP assistance to applicants for their uninsured or underinsured disaster-caused expenses and serious needs (see *Figure 8* for eligibility examples). Applicants are required to inform FEMA of all insurance (flood, homeowners, vehicle, mobile home, medical, burial, etc.) coverage that may be available to them to meet their disaster- caused needs. Insured applicants must provide documentation that identifies their insurance settlements or benefits before FEMA will consider their eligibility for categories of assistance that may be covered by private insurance.

Figure 8. Insurance Eligibility Examples

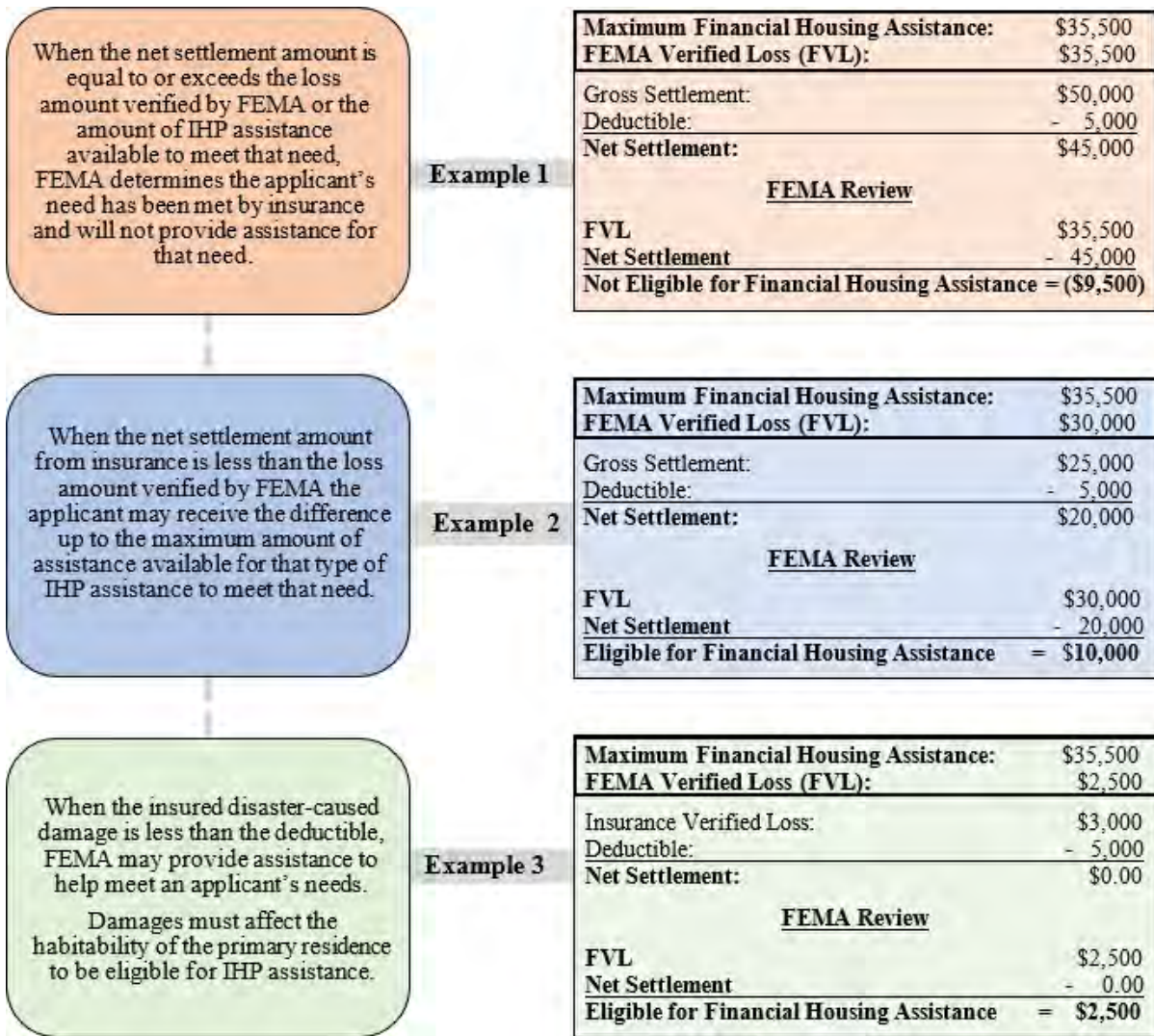

Insurance Deductible

In an insurance policy, the deductible is the amount that the policyholder agreed to pay out of pocket before an insurance company pays any benefits. This amount is subtracted from the total amount paid by the insurance company. Insurance premiums are typically more affordable when they involve higher deductibles.



FEMA-Verified Loss (FVL)

The total dollar amount of IHP eligible disaster-caused damage to real and personal property as verified by FEMA.

The FVL represents the total potentially eligible damage, but due to insurance coverage, the financial Housing Assistance maximum, and other eligibility factors an applicant may not ultimately receive assistance for their full FVL.

After an applicant submits their insurance settlement information, FEMA compares the net settlement amount received for each loss to the maximum amount of assistance available for that type of IHP assistance.

FEMA only considers insurance coverage which includes the peril(s) (e.g., flood, wind, wind-driven rain, tornado, fire, etc.) listed as a cause of damage identified for the disaster when determining eligibility for assistance. For example, an applicant is not required to submit flood insurance documents for a wind-only disaster. When applicants are impacted by multiple perils, FEMA compares insurance benefits and verified loss amount separately for each peril.

Exceptions:

- **Uninsurable Items:** Insured applicants may receive assistance for items not typically covered by homeowners or flood insurance, such as wells, septic systems, access roads, etc., regardless of the type of disaster-caused damage or the applicant's insurance coverage.
- **Delayed Settlement:** While FEMA cannot provide assistance for disaster-caused needs covered by insurance benefits, FEMA may provide assistance to help meet an applicant's immediate needs when their insurance benefits are delayed.⁶⁹ Two important conditions for receiving this form of FEMA assistance are:
 - Applicants who demonstrate their insurance settlement has been significantly delayed (30 days or more from the date a claim was filed) through no fault of their own, may be considered for initial Rental Assistance.⁷⁰
 - Applicants accepting assistance in advance of receiving their insurance settlement must agree to repay FEMA upon receiving their insurance settlement.

4. Occupancy

Applicants (both owners and renters) must be able to prove they occupied the disaster-damaged primary residence before receiving Housing Assistance and some types of ONA (i.e., Personal Property Assistance and Moving and Storage Assistance). Certain types of ONA do not require verification of occupancy of a primary residence; these include Transportation Assistance, Funeral Assistance, Medical and Dental Assistance, and Child Care Assistance.

All household members at the time of the disaster are considered occupants. Occupant means a resident of the housing unit.⁷¹ FEMA verifies occupancy through an automated public records search or submitted documents. In locations where automated verification of public records is limited, FEMA may partner with applicable authorities from the SLTT government to verify occupancy.

Occupancy Documentation:

When FEMA is unable to verify an applicant's occupancy of their disaster-damaged primary residence, the applicant may provide FEMA with any of the documents listed below for verification. FEMA will request additional documents from the list in *Figure 9* to prove occupancy in cases where the name reflected on utility bills and the name of the primary occupant conflict or when additional documentation is needed to clarify other conflicting information.

Figure 9 : Documentation to Verify Occupancy

Document and Description	Acceptable Document Dates
<p>Utility Bills: Electric, gas, oil, trash, water/sewer bills that reflect the name of the applicant or co-applicant and the disaster-damaged residence address.</p>	<p>Utility bills must be dated within 3 months prior to the incident period. Utility bills showing no usage, or only service charges, are not sufficient occupancy verification documents.</p>
<p>Merchant’s Statement: Bank or credit card statement, phone bill, cable/satellite bill, etc. that reflect the name of the applicant or co-applicant and the disaster-damaged residence address.</p>	<p>Merchant statements must be dated within 3 months prior to the incident period.</p>
<p>Employer’s Statement: Pay stubs and similar documents that reflect the name of the applicant or co-applicant and the disaster-damaged residence address.</p>	<p>Employer’s statements must be dated within 3 months prior to the incident period.</p>
<p>Lease/Housing Agreement: Copy of a written lease, housing agreement, or landlord’s written statement that includes the name of the applicant or co-applicant, the landlord contact information, the basic terms of tenancy including the location of the pre-disaster unit, amount of rent, and duration of the lease confirming that the applicant lived there at the time of the disaster; and signatures from both the landlord and applicant/co-applicant.</p>	<p>These documents must be issued and dated prior to the incident start date and current (not expired) at the time of the disaster.</p>
<p>Rent Receipts: Copy of a rent receipt or bank statement (with image of the cancelled check) that reflects the name of the applicant or co-applicant, the landlord’s contact information, the location of the pre-disaster unit, the amount of rent, and the landlord’s signature.</p>	<p>Rent receipts must be dated within 3 months prior to the incident period.</p>
<p>Public Official’s Statement: Public official’s (e.g., Police Chief, Mayor, Postmaster) written statement that includes the name of the applicant or co-applicant, the disaster-damaged residence address, the period of occupation, and the name and telephone number of the individual providing the verification.</p>	<p>Public official’s statements must be dated within the 18-month period of assistance or extended period of assistance.</p>
<p>Driver’s license, state-issued ID card, voter registration card that reflect the name of the applicant or co-applicant and the disaster-damaged residence address.</p>	<p>Identification documents must be issued and dated prior to the incident start date and current (not expired) at the time of the disaster.</p>

Document Exceptions:

- **Proof of Occupancy:** If the listed documentation is unavailable, FEMA may accept a written self-declarative statement as a last resort, only from the applicants living in insular areas, islands, and tribal lands. The statement must also include how long the applicant lived in the disaster-damaged residence prior to the Presidential disaster declaration, an explanation of the circumstances that prevent standard occupancy verification, and the applicant's signature. The self-declarative statement may be written post-disaster.
- **Intent to Occupy Statement:** Applicants not occupying the residence at the time of the disaster may still receive consideration for IHP assistance if they submit a written statement along with supporting verifiable documentation, such as a utility deposit or a pre-dated lease that contains the applicant/co-applicant's name and the residence address. Supporting documentation must be dated on or before the first day of the incident period.
 - **Example 1:** An applicant who recently purchased a home that was destroyed while the applicant was in the process of moving in may be eligible based on intent to occupy. Such applicants not occupying the residence at the time of the disaster may still be eligible if they submit documentation showing their intent to occupy the home as their primary residence.
 - **Example 2:** In addition to meeting general eligibility criteria (see Chapter 3, II.), incarcerated applicants must submit documentation verifying they will be released prior to the end of the assistance period, such as official documentation from the correctional facility or detention center, or information (e.g., name of incarcerated individual, city and state of the facility, etc.) necessary to complete an online search of the facility's online database to determine the release date, if available.
- If an incarcerated applicant is not released prior to the inspection, and cannot be present for an inspection, they must designate a third party 18-years or older to meet with the inspector on their behalf.

Citizenship and Occupancy: To meet the occupancy requirement, the applicant (or co-applicant) must prove occupancy and meet FEMA's citizenship requirement. If the applicant is a minor child, the co-applicant must be the child's parent or legal guardian, and prove they occupied the disaster-damaged residence at the time of the disaster.

Student Occupancy: Applicants who lived in housing provided by an educational facility (e.g., college dormitory) may be eligible for IHP assistance if the student housing was their primary residence. For additional information on student eligibility for disaster assistance, see [Chapter 3, II.B.](#)

5. Ownership

FEMA verifies ownership through an automated public records search or submitted documents. In locations where automated verification of public records is limited, FEMA may partner with applicable authorities from the SLTT government to verify ownership.

When an applicant's ownership of their pre-disaster primary residence has been verified, they may be considered for Home Repair Assistance, Home Replacement Assistance, or PHC Assistance.

FEMA defines an owner-occupied residence⁷² as one where the applicant:

- Is the legal owner who permanently resides at the disaster-damaged residence; or
- Does not hold a formal title to the residence and pays no rent, but is responsible for the payment of taxes or maintenance of the residence; or
- Has lifetime occupancy rights with formal title vested in another (see *Figure 10* for required documentation).

Ownership Documentation: When FEMA is unable to verify an applicant’s ownership of their primary residence, the applicant may provide FEMA with documentation to prove ownership. Applicants may provide additional documents from the list in *Figure 10*.

Figure 10: Documentation to Verify Ownership	
Document and Description	Acceptable Document Date
Deed or Official Record: Original deed or deed of trust to the property.	Deed must be current/effective during the disaster incident period.
Mortgage Documentation: Mortgage statement or escrow analysis.	The most recent mortgage statements available should be submitted (within three months of the disaster incident period) and escrow documents should be from the last quarter.
Real property* insurance document, bill, payment record, or structural insurance documentation. <i>*Buildings or other structures permanently attached to land, and the land itself. Includes items that are structural components of the buildings or structures.</i>	Within three months of the disaster incident period
Property tax receipt or property tax bill	Current and/or effective during the disaster incident period.
Manufactured home certificate of title	
Real Estate Provision	
Contract for Deed	
Land Installment Contract	
Quitclaim Deed	
Bill of Sale or Bond for Title	
Will or Affidavit of Heirship naming the applicant heir to the property and a death certificate	

The document provided must reflect:

- The name of the applicant or co-applicant registering for assistance;
 - If the applicant is a minor child, documentation must be in the parent/guardian co-applicant's name
 - If ownership is proven by an Affidavit of Heirship or a will, documentation must reflect the deceased owner's name, date of death, and evidence of the applicant's heirship. The will or Affidavit of Heirship documentation must comply with state law.
- The address of the disaster-damaged primary residence; and
- A date prior to the disaster incident period.

Document Exceptions: If the listed documentation is unavailable, FEMA may accept:

- A written self-declarative statement as a last resort, only from applicants living in insular areas, islands, and tribal lands. The statement must include the address of the disaster-damaged primary residence, how long the applicant lived in the disaster-damaged primary residence prior to the Presidential disaster declaration, an explanation of the circumstances that prevent standard ownership verification, and the applicant's signature. The self-declarative statement may be written post-disaster; however, FEMA will not accept a declarative statement of ownership for pre-disaster squatters.
- Evidence the applicant is financially responsible for major repairs to the primary residence. Evidence may include receipts that show the applicant was responsible for major repairs or maintenance (e.g., roof, furnace, plumbing, structural component repair or replacement).

Citizenship and Ownership: To meet the ownership requirement, the applicant or co-applicant must prove ownership and meet FEMA's citizenship requirements. If applying on behalf of a minor child, the applicant must be the owner of the home and the child's parent or legal guardian.

B. Additional Eligibility Considerations

Although general eligibility considerations apply to all IHP applicants, certain situations and living arrangements require additional clarification.

1. Condominiums and Cooperatives

FEMA may provide Housing Assistance and ONA to condominium (condo) owner-occupants and cooperative (co-op) owner-occupants for eligible disaster-caused damage they are responsible for within their unit (see *Figure 11*).

The owner of a condo or co-op unit is generally responsible for the fixtures, installations, and additions within the interior surfaces of the unit's perimeter walls, floors, and ceilings. This includes interior partitions, plumbing, appliances, and the exterior heating and cooling units from the point of supply into the unit. FEMA generally does not provide assistance for disaster-caused damage to structural elements (e.g., roof, exterior walls, chimneys, and shared foundation) and common areas shared by all residents such as recreational facilities, outdoor space, parking, landscaping, fences, laundry rooms, and all other jointly-used space.

The condo or co-op association’s master insurance policy generally covers damage to common areas and structural elements of the building that are shared by all residents. If the condo or co-op association does not hold an insurance policy for a particular peril and the association is responsible for the item, FEMA will not assist with the expenses related to any damage or the assessment fees resulting from the disaster due to the item being a shared common area expense.



Condominium vs. Cooperative

A **condominium residence** generally is a type of housing where each resident owns their individual unit in a multi-unit building and shares the costs of maintaining the structural elements and common areas (i.e., roof, hallway, HVAC, walkways).

A **cooperative residence** is generally a type of housing wherein residents are shareholders of a corporation that owns the building and/or property where they reside. The share entitles each resident exclusive use of the unit they live in.

Figure 11: Condo and Co-op Assistance

Building Portion	Responsible Party	Insurance Policy Type	Eligible for IHP
Condo or co-op unit, walls in	Unit owner	Unit owner’s policy	Yes, if uninsured or underinsured losses
Damaged structural elements and common areas shared by all residents	Condo or co-op association	Condo or co-op association’s master policy	No, unless applicant submits documentation indicating individual responsibility

Individual condo or co-op owners who claim responsibility for damaged structural elements (e.g., roof, exterior walls, chimneys, and shared foundation) or damaged items in common areas need to submit verifiable documentation to FEMA indicating individual responsibility, including the master policy or bylaws, in order to be considered for assistance.

2. Limited Liability Company

Individuals or households living in properties owned by a Limited Liability Company (LLC) or time-share properties are considered renters and generally are not eligible for Home Repair Assistance or Home Replacement Assistance. However, an applicant occupying a dwelling owned by an LLC or other similar legal entity may be eligible for Home Repair Assistance or Home Replacement Assistance if they provide documentation that proves:

- The applicant occupies the dwelling as their primary residence;
- The legal entity does not have commercial purposes, such as ownership of more than one dwelling;
- The applicant or member of the household is the sole member of the legal entity;
- The dwelling is uninsured or underinsured; and
- All other Conditions of Eligibility are satisfied.

Applicants who own a dwelling on LLC-owned land may also be eligible for Home Repair Assistance or Home Replacement Assistance if they prove ownership of the home. FEMA may request additional documents to prove ownership when additional information is needed or to clarify conflicting information.

Applicants living in dwellings owned by an LLC or other similar legal entity will remain eligible for all categories of assistance that do not require ownership verification.

3. Separated Households

FEMA may provide Rental Assistance and/or LER to members of a family or household who were separated during a disaster through no fault of their own, such as those who were evacuated to different locations. Once the separated household members reunite, any eligible Continued Temporary Housing Assistance (see [Chapter 3, IV.C.](#)) will continue under the head of household's application to ensure no duplication of benefits (DOB). Rental Assistance provided to the previously separated household members will cease to ensure no DOB. Each application's total number of months and total amount of Rental Assistance and LER awarded is compared to the 18-month assistance period separately. Generally, FEMA provides all eligible IHP awards under only the head of household's application to assist all members of the pre-disaster household. Only the head of household will be eligible for additional categories of IHP assistance.

4. Roommates and Boarders

FEMA defines roommates as household members with an independent financial responsibility for the housing unit that are not dependents of each other and are not married, such as renters whose names are on a lease.

FEMA considers boarders as individuals or families in a private commercial relationship with the landlord. Boarders may reside in a housing unit with the landlord/head of household or in a separate housing unit within the structure.

FEMA defines a commercial relationship as a formal agreement to rent a portion of a residence from the owner.



Housing Unit

Housing unit is defined as a house, apartment, manufactured home, recreational vehicle, readily-fabricated dwelling, houseboat, or any other distinctly-separated living space. A living space may qualify as a housing unit if it includes facilities for cooking, eating, and sanitation. It must be directly accessible from an outer door or through an interior door in a shared hallway rather than by walking through another household's living space.

Figure 12: Assistance for Roommates and Boarders		
Type of Assistance	Eligible Party	Limitations
Personal Property Assistance	Each roommate and boarder with individually-owned items	Combined applications for same housing unit cannot exceed a specific line item maximum quantity limit
Medical and Dental Assistance Funeral Assistance Child Care Assistance Moving and Storage Assistance Miscellaneous Items Transportation Assistance Group Flood Insurance Policy	Each roommate and boarder	Standard criteria
Rental Assistance	<p>First roommate who applies, unless roommates are unable to relocate together due to extenuating circumstances</p> <p>Boarders residing in the same housing unit as the landlord/head of household, if unable to relocate together due to extenuating circumstances</p> <p>Boarders residing in a separate housing unit within the structure may be eligible for Rental Assistance separate from the landlord</p>	FEMA expects all household members residing in the same housing unit to relocate together



A FEMA inspector verifies wildfire damage at a severely impacted home site in Texas.

Roommates and boarders must be able to demonstrate a formal agreement or financial responsibility to the household. A pre-disaster financial responsibility or formal agreement can be supported by one of the following:

- Pre-disaster rent receipts, cancelled checks, or money orders for the disaster-damaged primary residence;
- Pre-disaster lease, landlord's written or verbal statement, or rental agreement for the disaster-damaged primary residence; or
- Pre-disaster major utility bills (water, electricity, or gas) in the roommate's or boarder's name for service at the disaster-damaged primary residence.

Roommates and boarders may be eligible for individually-owned ONA personal property items and identified miscellaneous line items on the *ONA Administrative Option Selection Form*. They will be considered under separate applications, but all the applications combined cannot exceed what FEMA identifies as the maximum quantity limit for a specific line item for a housing unit. FEMA awards assistance to the landlord/head of household or the first roommate that applies. Subsequent applicants designated as roommates or boarders will only receive assistance for non-duplicative line items; however, this limitation excludes boarders residing in a separate housing unit. Designation as a roommate or boarder does not impact an applicant's eligibility for Medical and Dental Assistance, Funeral Assistance, Child Care Assistance, Moving and Storage Assistance, Transportation Assistance, or GFIP under ONA.

Generally, FEMA awards Rental Assistance under one household member application for the housing unit, with the expectation that the household will relocate together. In some instances, Rental Assistance may be provided to individual roommates or boarders when they are unable to relocate with the household due to extenuating circumstances. In order for FEMA to process Rental Assistance, the individual roommate or boarder must submit a written statement explaining the extenuating circumstances that prevented the household from relocating together along with supporting documentation, if applicable.

5. Military Personnel

FEMA may provide assistance to eligible active duty military and civilian military employees if the assistance is not duplicated from available assistance from the military such as the Military Personnel and Civilian Employees' Claim Act.

FEMA does not automatically provide Rental Assistance for applicants who live in military-provided housing that received disaster-caused damage. However, applicants living in military housing may receive FEMA Rental Assistance if they provide documentation showing they are not receiving housing assistance from another source.



Military Personnel

The *Military Personnel and Civilian Employees' Claim Act* provides assistance to active duty military personnel and military civilian employees in military housing for personal property (including vehicles) as a result of disaster-caused damage or loss.

The *Safe Haven Allowance* from the Department of Defense (DOD), assists military personnel and their families with disaster-caused housing costs.

Active duty military members who can satisfy occupancy and ownership conditions of eligibility for their privately-owned pre-disaster primary residence may be eligible for all categories of assistance. Active duty military members are ineligible for assistance if they are not occupying their privately-owned residence at the time of the disaster or cannot prove their intent to occupy the residence within the period of assistance. Active duty military personnel stationed outside of the country can authorize a third party to be present for inspection of their primary residence within the declared area. All military personnel, regardless of residence type or military status, may be eligible for ONA if the items are not covered by the Military Personnel and Civil Employees' Claim Act.

6. *Students*

FEMA may provide assistance to students who have disaster-caused damage or losses. Students living in housing provided by an educational facility may be eligible for Housing Assistance. FEMA determines eligibility for Rental Assistance based on whether the student applicant is “dependent” or “independent” and whether the housing is their primary residence. Independent students living in college dormitories may be eligible for Rental Assistance; dependent students are not eligible for Rental Assistance.



Students

Eligible student applicants may receive Medical and Dental Assistance, Funeral Assistance, Moving and Storage Assistance, Transportation Assistance, Assistance for Miscellaneous Items, and Child Care Assistance under ONA regardless of their residence type or dependent status.

Personal Property Assistance is available for uninsured damaged items regardless of the student’s residence type or dependent status. Personal Property Assistance is limited to student-owned items recorded during FEMA inspection. This excludes items provided by the institution or covered by an insurance policy.



Independent

The term “Independent” refers to students who are financially independent from parent(s) or guardian(s) and:

- Do not have a primary residence elsewhere and are responsible for their own living expenses;
- Are at least age 24 by December 31 of the award year;
- Were married prior to the disaster;
- Are in a masters or doctorate program;
- Have legal dependents;
- Are an orphan or ward of the court;
- Are on active military duty or are a military veteran; or
- Have documented determination of independent status by a financial aid administrator.

7. Pre-Disaster U.S. Department of Housing and Urban Development (HUD) Applicants

FEMA works closely with HUD to ensure applicants who were pre-disaster recipients of HUD assistance receive the appropriate form of FEMA Temporary Housing Assistance after a disaster.

Because FEMA may not duplicate assistance with any other Federal program, insurance, voluntary organization, or other entity, the applicant, FEMA, and HUD must work closely to determine the appropriate responsibility for the applicant's disaster housing needs. FEMA's Joint Field Office (JFO) will work with HUD counterparts at the SLTT government levels to determine which applicants were assisted by HUD prior to the disaster. Applicants' eligibility for FEMA Temporary Housing Assistance will be based on the availability of HUD assistance for the applicants after the disaster.

Once HUD assistance is available and offered to the applicant by HUD, the applicant will no longer be eligible for FEMA Temporary Housing Assistance. At this time, if they refuse to receive HUD assistance, they will no longer be eligible for continued disaster-related HUD assistance. For limitations and exclusions, see [Chapter 3, IV.A.3](#).

8. Residents of Assisted Living Facilities

Applicants whose primary residence is an assisted living facility may receive assistance for housing, personal property, and other disaster-caused needs not covered by the assisted living facility. Assisted living facilities are usually responsible for relocating their residents to temporary housing, if necessary. In some instances, certain furnishings in the residence may belong to the assisted living facility.

FEMA provides assistance to applicants living temporarily in a hospice, hospital, nursing home facility, or similar facility at the time of the disaster, and who have a primary residence in the declared area. The applicant must demonstrate their current living situation is temporary, they intend to relocate back to their damaged primary residence, and their housing needs are not being met by the temporary living facility.

Applicants living in assisted living facilities may still be eligible for certain ONA types, such as Personal Property Assistance and Moving and Storage Assistance.

9. Homeless

FEMA does not provide Housing Assistance (Rental Assistance, direct assistance, Home Repair Assistance, or Home Replacement Assistance) to applicants experiencing homelessness because the need for housing was not caused by the disaster.

Applicants experiencing homelessness pre-disaster may be eligible for certain types of ONA (Transportation Assistance, Medical and Dental Assistance, Funeral Assistance, and Child Care Assistance).



Definition of Homeless

An applicant experiencing homelessness is an individual whose pre-disaster living arrangements were transient in nature and void of any form of structural ownership. Examples of homeless living situations may include rent-free shelters, bridges, underpasses, or streets.

10. Residents of Non-Traditional Housing

FEMA may provide initial Rental Assistance and ONA to applicants who resided in non-traditional forms of housing (e.g., tents and certain types of huts and lean-to structures) pre-disaster.

Non-traditional housing may be more prevalent in certain areas, such as tribal communities, territories, and insular areas. Occupancy must be verified by a credible or official source (e.g., tribal council, public official, homeless outreach advocate) at the time of inspection. Applicants may also verify occupancy by submitting any document listed in [Chapter 3, II.A.4](#), or a signed, written statement from a credible or official source, which includes the applicant’s name, location of residence, dates of occupancy pre-disaster, and the source’s name, title, and contact information.

If pre-disaster occupancy cannot be verified, applicants may only be eligible for types of ONA that do not require occupancy verification (Transportation Assistance, Medical and Dental Assistance, Funeral Assistance, and Child Care Assistance). FEMA does not provide direct assistance, Home Repair Assistance, Home Replacement Assistance, or Continued Temporary Housing Assistance to residents of non-traditional housing.



Definition of Non-Traditional Housing

Non-traditional housing is a form of dwelling void of structural floor, structural walls, and structural roof.

Figure 13: Assistance for Residents of Non-Traditional Housing

Eligible Party	Type of Assistance	Limitations
Applicants who resided in non-traditional housing who are unable to verify occupancy	<ul style="list-style-type: none"> • Transportation • Medical and Dental • Funeral • Child Care 	<ul style="list-style-type: none"> • Ineligible for all forms of Housing Assistance • Ineligible for forms of ONA that require successful verification of occupancy (Personal Property, CNA, and Moving and Storage)
Applicants who resided in non-traditional housing (i.e., tents, etc.) who are able to verify occupancy	<ul style="list-style-type: none"> • Initial Rental Assistance • LER • All types of ONA 	<ul style="list-style-type: none"> • Ineligible for Continued Temporary Housing Assistance or direct assistance • Ineligible for Home Repair or Replacement Assistance

11. Flood Zones and Protected Areas

Restrictions and conditions apply to the IHP assistance FEMA provides in Special Flood Hazard Areas (SFHAs), sanctioned communities, Coastal Barrier Resources System (CBRS) units, and otherwise protected areas (OPAs).

National Flood Insurance Reform Act (NFIRA)

NFIRA and FEMA regulations require applicants who receive Federal financial assistance to purchase flood insurance for future flood damage to any insurable property for acquisition or construction purposes. This requirement applies only to real and personal property that is, or will be, in a designated SFHA and can be insured under the National Flood Insurance Program (NFIP). For purposes of IHP, Federal financial assistance means assistance in the form of Home Repair Assistance, Home Replacement Assistance, PHC, or Personal Property Assistance. Therefore, applicants who live in a designated SFHA and receive IHP assistance for Home Repair Assistance, Home Replacement Assistance, PHC, or Personal Property Assistance must obtain and maintain flood insurance coverage for at least the amount of disaster assistance they receive from FEMA for NFIP-insurable items real or personal property. Applicants may satisfy the insurance requirement by purchasing private insurance or a policy through the NFIP.

Applicants who do not obtain and maintain flood insurance will be ineligible for IHP assistance for flood-damaged real or personal property in future disasters with flood-related damage.

A dwelling may be insurable by the NFIP if it meets the NFIP definition of a building, which is defined as “a structure with two or more outside rigid walls and a fully secured roof, that is affixed to a permanent site.”⁷³ If an applicant is provided IHP assistance for flood-damaged real property and the dwelling is uninsurable through NFIP, the applicant will not be eligible for flood-damaged real property losses in future disasters with flood-related damage.

The NFIP was created to reduce the impact of flooding on private and public structures by providing affordable insurance to property owners and by encouraging communities to adopt and enforce floodplain management regulations. If a property is later remapped and no longer determined to be in a designated SFHA, the flood insurance requirement will no longer apply.

Coastal Barrier Resources Act (CBRA)

CBRA protects coastal areas from development by limiting Federal financial assistance for development-related activities in designated CBRS areas. CBRS areas are coastal areas that protect valuable habitat for fish and wildlife and are subject to wave, wind, and tidal forces; these areas are mapped by the U.S. Fish and Wildlife Service. The CBRS contains two types of coastal barrier areas: CBRS Units and OPAs.

An eligible applicant whose pre-disaster primary residence is located within a CBRS Unit may not be considered for Home Repair Assistance, Home Replacement Assistance, PHC, or certain types of ONA.

An eligible applicant may be considered for Rental Assistance and the following types of ONA:

- Funeral Assistance
- Medical and Dental Assistance
- Child Care Assistance
- Critical Needs Assistance

- Clean and Removal Assistance
- Assistance for Miscellaneous Items
 - Financial assistance may not be considered for items obtained after the start of the incident period that are typically used to rebuild the pre-disaster residence.⁷⁴ However, assistance may be awarded for expenses to purchase or rent items required to power life-sustaining medical equipment (e.g., generators; see [Chapter 3, VI.B.4](#)).

FEMA may not provide Direct Temporary Housing Assistance in the forms of MLR or TTHUs within a CBRS Unit. However, an applicant may be eligible to receive these forms of assistance provided in locations outside of the CBRS Unit.

An eligible applicant whose pre-disaster primary residence is located within an OPA may be considered for all forms of IHP assistance; however, the residence is also subject to NFIRA requirements for sanctioned communities and SFHAs, if applicable (see [Chapter 3, II.B.10](#)). Federal flood insurance through the NFIP is not available in CBRS Units or OPAs.

Sanctioned Communities

Sanctioned community means a community in which FEMA has identified SFHAs on a Flood Insurance Rate Map (FIRM) and the community has failed to join the NFIP within one year of the FIRM being published. Although a community's participation in the NFIP is voluntary, participation is required for purchase of Federal flood insurance within the community and requires the community to adopt and enforce a flood damage prevention ordinance. A suspended community is a community in which FEMA has identified SFHAs on a FIRM, but FEMA has suspended the community from the NFIP for failure to enforce a flood damage prevention ordinance in compliance with the NFIP.

Applicants who have disaster-caused flood damage to their primary residence in a sanctioned community are not eligible to receive assistance for NFIP-insurable real and personal property items damaged by flooding.⁷⁵ However, the individual or household may be eligible,⁷⁶ if the community in which the damaged property is located qualifies for and enters the NFIP during the 6-month period following the declaration.

Applicants who fail to obtain and maintain flood insurance, or live in sanctioned communities may be eligible for all the following, if general IHP conditions of eligibility are met:

- Medical and Dental Assistance, Funeral Assistance, Assistance for Miscellaneous Items, Child Care Assistance, Moving and Storage Assistance costs over \$1,000 (NFIP covers the first \$1,000 of moving expenses), Transportation Assistance, and CNA;
- Rental Assistance or Direct Temporary Housing Assistance in the form of Multi-Family Lease and Repair, TTHUs, or Direct Lease;
- Real and Personal Property items not damaged by flooding; and
- Uninsurable damaged items, such as wells and septic systems.

Figure 14: Flood Insurance Requirements for Homeowners and Renters	
Owners	Flood insurance coverage must be maintained at the address for as long as the address exists and for at least the assistance amount awarded for flood-damaged, NFIP-insurable losses. If the home is sold or otherwise becomes owned by someone else, the requirement to purchase and maintain flood insurance carries over to any subsequent owner.
Renters	<p>Flood insurance coverage must be maintained on the contents for at least the IHP assistance amount awarded for flood-damaged, NFIP-insurable personal property, as long as the applicant lives at the flood-damaged rental property address. The requirement is lifted once the applicant permanently moves from the rental unit.</p> <p>Subsequent renters will not be required to maintain flood insurance for their personal property unless they previously received IHP assistance for flood-damaged, NFIP-insurable personal property while residing at the same address.</p> <p>Note: If a pre-disaster renter becomes an owner by purchasing the rental property at which they received IHP assistance for their flood-damaged, NFIP-insurable personal property losses, but fails to maintain the flood insurance on their personal property, they may receive IHP assistance for flood-damaged real property losses; however, they will not be eligible for Personal Property Assistance.</p>
*44 C.F.R. § 206.110(k)(3)(i)(A)	

Applicants may also receive Mass Care and Emergency Assistance (MC/EA), including congregate sheltering ([Chapter 2, II.](#)) and Transitional Sheltering Assistance (TSA) ([Chapter 2, IX.](#)), Crisis Counseling ([Chapter 5](#)), Disaster Unemployment Assistance (DUA) ([Chapter 7](#)), Disaster Legal Services ([Chapter 6](#)), and Disaster Case Management ([Chapter 4](#)).

Flood Insurance Requirement for Recreational Vehicles

Recreational Vehicles (RVs) may include motorized vehicles (i.e., Class A, B, or C vehicles, or motorhomes) and travel trailers (e.g., fifth wheel, pop-up camper, etc.).

Generally, motorized vehicles are not insurable as property by the NFIP. Applicants whose primary residence is a motorized vehicle are exempt from the requirement to obtain and maintain flood insurance and may be eligible for IHP assistance, even if they received IHP assistance for flood-damaged personal property in a previous disaster.

RVs without wheels, built on a chassis, and affixed to a permanent foundation (referred to as “travel trailers”)⁷⁷ are insurable under the NFIP. Applicants located in an SFHA, who previously accepted IHP assistance for a flooding incident and whose primary residence is a travel trailer,⁷⁸ are required to obtain and maintain flood insurance for as long as the address exists for at least the amount of flood-damaged IHP assistance received for real and/or personal property.

Applicants with a NFIRA requirement, who fail to affix a travel trailer to a permanent foundation and/or to properly elevate the travel trailer in compliance with the community’s floodplain management requirements, rendering the unit uninsurable under NFIP, will be ineligible to receive any Federal assistance for flood-damaged real or personal property⁷⁹ in a future disaster.⁸⁰

30-Day Period for Applicants to Decline Financial Assistance

An applicant has 30 days to decline financial assistance that would trigger the flood insurance obtain and maintain requirement. Applicants who do not wish to obtain and maintain flood insurance must return all disaster assistance they receive for NFIP-insurable real and personal property to FEMA no later than 30 days from the date of the award determination letter from FEMA.

C. Appeal Process

1. Timeline for Appeal

Applicants must appeal initial eligibility determinations⁸¹ within 60 days of the date on their eligibility notification letter.⁸²

2. Determinations that May be Appealed

Applicants may submit a written appeal if they disagree with any FEMA determination. An applicant may appeal:

- Initial eligibility determinations for Housing Assistance and ONA, including:
 - The amount or type of Housing Assistance and ONA an applicant received;
 - The decision to withdraw an application for FEMA disaster assistance;
 - The recovery of funds improperly awarded to an applicant (see [Chapter 3, VII](#)); or
 - The denial of a late application request for assistance.
- A denial for Continued Temporary Housing Assistance.
- Direct Housing Assistance determinations, including:
 - The termination of eligibility to remain in a temporary housing unit;
 - FEMA's intent to collect rent or the amount of rent collected from occupants of a FEMA-provided temporary housing unit;
 - A denial of a request to purchase a FEMA-provided MHU;
 - The sales price of a FEMA-provided MHU the applicant may want to purchase; or
 - Any Individual Assistance eligibility or participation-related determination, action or inaction.

When ONA is administered under the Joint or State Option described in ONA Cost Share and Administration (see [Chapter 3, VI.A.2](#)), the applicant must submit their appeal to the STT government. FEMA does not accept multiple appeals for the same reason, but may request additional information and conduct additional reviews as new information is received.

3. Requests for Copies of IHP Assistance File

Applicants may submit a written, signed request for a copy of FEMA's records related to their application for IHP assistance. The request must be in writing and specifically state what information the applicant would like to receive (e.g., entire file copy, copy of all correspondence from FEMA, etc.) and who is to receive the requested information (e.g., self, attorney, friend, etc.). If the file copy is to be provided to a third party, the full name and address of the third party must be included in the request.

The request must include the following for identity verification purposes:

- Applicant's full name
- Applicant's FEMA Application Number and Disaster Number
- Damaged property address and current mailing address, if different
- Applicant's date and place of birth
- Applicant's signature with one of the following:
 - Notary stamp or seal; or
 - The statement "I hereby declare under penalty of perjury that the foregoing is true and correct."

Written requests can be mailed or faxed using the information below.

- **Mailing Address:** Individuals and Households Program, National Processing Service Center; P.O. Box 10055; Hyattsville, MD 20782-8055
- **Fax Number:** 800-827-8112

If a Disaster Assistance Center account has been created, applicants can also upload documents through the Upload Center in their online account.

4. Appeal Submission

The applicant's appeal letter must explain the reason(s) for appeal and must be signed by the applicant or person who the applicant authorizes to act on their behalf.

The appeal submission should also include the following information:

- Applicant's full name
- Applicant's FEMA Application Number and Disaster Number
- Address of the applicant's pre-disaster primary residence
- Applicant's current phone number and address

Figure 15: Sample Appeal Letter

	Applicant Name Application Number Disaster number Street Address City, State, Zip Phone number
Dear FEMA,	
On February 17, 2016, I received a letter from you stating that I am ineligible for assistance because I have insurance. I would like to appeal your decision, as my insurance company will not cover the damage.	
Enclosed please find my insurance denial letter showing that I do not have insurance coverage for the damage to my home and personal property located at 123 Main Street, Everytown, Virginia.	
Please review the enclosed information and reconsider your decision.	
Thank you,	
Applicant [Signature]	

If someone other than the applicant files the appeal, the applicant must also submit a signed statement giving that person authority to represent the applicant.⁸³ See Written Consent ([Chapter 3, II.C.1](#)) for more information. The appeal letter should be accompanied by documentation to support the appeal request, such as repair estimates, contractor estimates, or other supporting documentation.

5. Appeal Determination

After FEMA receives the appeal, a caseworker with no prior involvement in the case reviews the appeal and file to determine if there is sufficient documentation to change FEMA's determination. If more information is needed in order to make a determination, FEMA takes one or more of the following actions:

- Calls the applicant and sends a letter requesting additional information with a deadline of 30 days to submit the additional information
- Contacts a third party, such as a contractor, insurance company, or mechanic in order to verify submitted information
- Schedules an appeal inspection

FEMA notifies applicants in writing about the appeal decision within 90 days of the receipt of the appeal letter.⁸⁴ FEMA's appeal decision represents the final agency determination and cannot be appealed again.⁸⁵

III. Delivering Individuals and Households Program Assistance

This section discusses the disaster assistance registration process, FEMA’s process for verifying disaster-caused losses, and communication with applicants, as well as considerations for successfully providing equal access and delivering IHP assistance to all disaster survivors without discrimination. An applicant for IHP assistance will not be denied benefits or Federal financial assistance on the grounds of race, color, religion, nationality, sex, age, disability, English proficiency, or economic status, pursuant to Section 308 of the Stafford Act⁸⁶ and 44 C.F.R. Part 7.

A. Applying for FEMA IHP Assistance

After the President declares a major disaster or emergency, FEMA coordinates with the respective STT government to determine the area designated for IA, establish a registration period, and provide multiple channels for disaster survivors to apply for IHP assistance.

1. Application Methods

FEMA offers disaster survivors multiple options to apply for IHP assistance and to receive updates on their application. Information on resources for non-English speakers can be found in [Chapter 1](#).

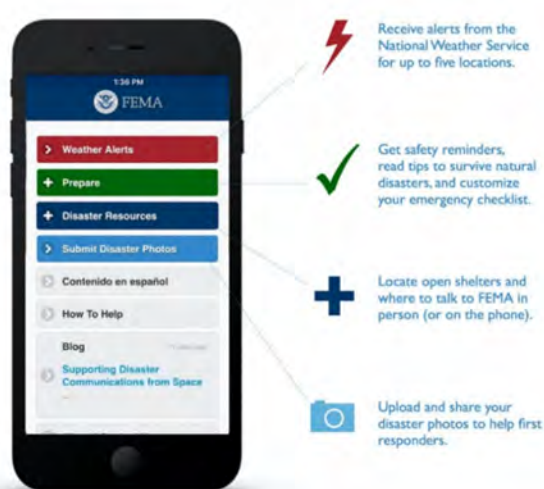

Access FEMA via smartphone through the application at www.fema.gov.

- Internet or Smartphone Application:** Disaster survivors may apply for IHP assistance or check their status at www.disasterassistance.gov. Disaster survivors may access FEMA via smartphone by visiting www.disasterassistance.gov or by downloading the FEMA application from www.fema.gov or through their mobile provider’s application store.
- Toll-free Helpline:** Disaster survivors may call FEMA toll-free at 800-621-3362 to register for assistance or check their application status. Disaster survivors who are deaf, hard of hearing, or have a speech disability and use a Text Telephone (TTY) may call 800-462-7585. Disaster survivors who use 711 or VRS (Video Relay Service) may call 800-621-3362.
- Disaster Recovery Centers (DRCs):** Disaster survivors may apply for assistance in person at a DRC in or near their communities. FEMA and applicable STT governments and communities work together to quickly establish DRCs in convenient locations within an area impacted by a disaster. The variety of services available at DRCs give survivors the ability to “one-stop shop” for disaster related programs and receive help in navigating the path toward recovery. DRCs

are usually opened quickly after a disaster for a limited period of time. They are accessible and equipped to accommodate disaster survivors who need disability-related communication aids. FEMA staff can assist with completing registrations or checking their application status.

- **Disaster Survivor Assistance (DSA) Teams:** FEMA may send staff into the affected communities to help disaster survivors apply for IHP assistance. FEMA may also coordinate with the SLTT government to send staff into emergency shelters to assist survivors. FEMA staff are equipped with computers or similar devices to assist survivors with registering for IHP assistance or providing them referrals to other resources.

2. Registration Period

Disaster survivors may apply for assistance after the start of the registration period. The application process begins with disaster survivors completing a registration with FEMA through any of the channels described above.

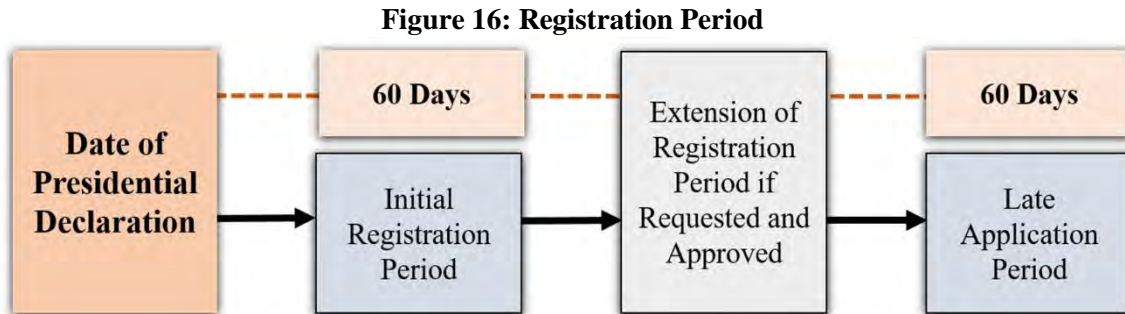

- **Initial Period:** The standard FEMA registration period is 60 days following the date the President declares a disaster for the designated area. The 60-day registration period starts on the date IA was designated for the declaration.⁸⁷
- **Extensions of the Registration Period:** FEMA may extend the registration period when the STT government requests more time to collect registrations from the affected population. Examples of situations when an extension may be warranted include, but are not limited to when:
 - Necessary to establish the same registration deadline for subsequently designated contiguous areas;
 - There is a continued high volume of registrations; and/or
 - There are significant barriers to registration (i.e., extended loss of electricity).



Subsequently Designated Areas

For individuals in areas subsequently designated for IA after the date of declaration, the registration deadline is still 60 days after the date of declaration, not 60 days from the day the county or parish was designated for IA, unless extended.

Extensions may be approved as follows:

- The Regional Administrator, or their designee, may extend the initial registration period up to 60 days.
- Any subsequent extensions must be approved by the IA Division Director (IADD).
- **Late Application:** After the end of the registration period, FEMA will accept late applications for an additional 60 days. FEMA will not allow applications after the 60-day grace period, however, in order for FEMA to process late applications, the applicant must submit a letter to FEMA that explains the extenuating circumstances that prevented them from applying for assistance in a timely manner and signed by the applicant or person who the applicant authorizes to act on their behalf.⁸⁸ The letter should also include documentation justifying the extenuating circumstances. The documentation provided must be dated immediately prior to or within the FEMA registration period. Acceptable documentation may include:
 - Record of hospitalization, illness, or disability of the applicant or an immediate family member;
 - Record of death for an immediate family member; or
 - Proof of personal or business travel that kept the applicant out of the area for the full application period.

3. Information Needed to Complete Application

FEMA requires all individuals registering for disaster assistance to self-certify and declare, under penalty of perjury, that they are a U.S. citizen, non-citizen national, a qualified alien, or the parent or guardian of a minor who is a U.S. citizen, non-citizen national, or qualified alien, and acknowledge the terms of the Privacy Act and Declaration of Eligibility Statement (*see Figure 17* for an excerpt of the statement).

Figure 17: Privacy Act Statement and Declaration of Eligibility

The image shows a screenshot of a form titled "Privacy Act Statement and Declaration of Eligibility". At the top right, there is a blue header with the text "Application Progress" and a row of ten small circles, with the first one filled. Below the title, the text reads "OMB No. 1660-0002, Exp. 11-30-2017". The main body of the form contains the following text: "FEMA is required by law to provide you with a copy of the Privacy Act Statement." followed by a paragraph under the heading "CITIZENSHIP: In order to be eligible to receive FEMA Disaster Assistance, a member of the household must be a citizen, non-citizen national or qualified alien of the United States. Please feel free to consult with an attorney or other immigration expert if you have any questions. By checking the box below, you hereby declare under penalty of perjury, that you are a citizen or non-citizen national of the United States, or a qualified alien of the United States, or a parent or legal custodian of a child who is a minor, who resides with you and who is a citizen, naturalized citizen or qualified alien of the United States. .". Below this is a paragraph under the heading "AUTHORITY: The Robert T. Stafford Disaster Relief and Emergency Assistance Act as amended, 42 U.S.C. § 5121-5207 and Reorganization Plan No. 3 of 1978; 4 U.S.C. §§ 2904 and 2906; 4 C.F.R. § 206.2(a)(27); the Personal Responsibility and Work Opportunity Reconciliation Act of 1996 (Pub. L. 104-193) and Executive Order 13411. DHS asks for your SSN pursuant to the Debt Collection Improvement Act of 1996, 31 U.S.C. § 3325(d) and § 7701(c)(1).". At the bottom is a paragraph under the heading "PRINCIPAL PURPOSE(S): This information is being collected for the primary purpose of determining eligibility and administering financial assistance under a Presidentially-declared disaster. Additionally, information may be reviewed within FEMA for quality assurance purposes and used to assess FEMA's customer service to disaster assistance applicants."

In addition, applicants must also provide all the following information to complete their application:

- Name and SSN of the primary applicant
- Name and SSN of secondary/co-applicant (encouraged but not required)
- Current and pre-disaster address
- Names of all occupants of the pre-disaster household
- Current contact information
- Types of insurance held by the household
- Household pre-disaster annual gross income
- Losses caused by the disaster
- Banking information for direct deposit of financial assistance, if requested

B. Verifying Losses

Once disaster survivors register for assistance, FEMA is required to verify losses to determine their eligibility for IHP assistance. FEMA uses multiple loss verification methods, including:

- Onsite inspection
- Geospatial inspection
- Documentation

FEMA's standard loss verification method for initial eligibility determination is an on-site inspection by a FEMA inspector.

FEMA may, at its discretion, determine other methods of verification (i.e., geospatial inspection) that will be used to help verify loss and deliver assistance. FEMA may also review and verify documentation such as medical bills or auto repair receipts for disaster-caused losses that cannot be verified through on-site or geospatial inspections.



A FEMA inspector speaks with a resident of a home damaged by Hurricane Sandy during an on-site inspection in New Jersey.

1. Onsite Inspection

FEMA inspectors typically schedule an on-site inspection with the applicant within two weeks after the applicant has registered for disaster assistance. FEMA inspectors are typically hired contractors, must pass a background check prior to working with FEMA, and are issued a badge identifying them as a FEMA contractor.

The FEMA inspector does not determine the applicant's eligibility for disaster assistance. During the inspection, the FEMA inspector assesses damage to the disaster-damaged primary residence and personal property such as furniture, appliances, vehicles, and essential equipment for daily household needs. IHP assistance may be awarded if, during inspection, the inspector determines the damage was caused by the disaster and affects the functionality of the home. FEMA inspectors will not physically inspect areas it is unsafe for them to access. Specifically, the FEMA inspector will:



A FEMA inspector arrives for an on-site inspection and shakes hands with a tornado survivor in Oklahoma.

- Verify the applicant's name, address, contact information, and insurance;
- If required for a specific disaster, collect the applicant's signature on the *Declaration and Release form (FEMA Form 009-0-3)* certifying the applicant's citizenship or eligible immigration status;
- Confirm individuals living in the disaster-damaged residence; bedrooms occupied; clothing, medical, dental, transportation, or miscellaneous losses; and items purchased as a result of the disaster (e.g., chainsaw, dehumidifier);
- Assess the pre-disaster residence's structure, furniture, and appliances for damage caused by the disaster, as well as undamaged items;
- Document the pre-disaster residence's square footage, foundation, and structural type (e.g., one or multiple stories). Record the cause of damage, applicable water levels, impacted utilities, and accessibility features; and
- Confirm with the applicant all damage has been viewed, describe next steps in the FEMA process, and advise the applicant to contact FEMA's Helpline (800-621-3362) to request information such as status updates, types and amount of assistance awarded, required documentation, and/or general questions about IHP assistance.

Applicants who cannot meet the inspector on-site may write to FEMA authorizing a third party over the age of 18 (e.g., neighbor, landlord) to attend the inspection on their behalf. Applicants whose pre-disaster residence is inaccessible may meet the FEMA inspector at an alternate location.

Applicants with limited English proficiency, or those who are deaf or hard of hearing, can request translation services, a qualified sign language interpreter, or other accommodations for inspections.

Applicants may request accommodations by contacting FEMA’s Helpline, visiting a DRC, or speaking with a DSA Team. Once the inspection is complete, the inspector will submit the inspection record to FEMA, which will consider the information when determining eligibility for IHP assistance.

In some cases, FEMA may conduct another inspection to validate losses if, for example, areas of the residence are initially inaccessible, or in cases where the applicant appeals FEMA eligibility determinations. Inspectors do not perform inspections on residences they have previously evaluated; appeal inspections are conducted by a different inspector to ensure a fair and impartial assessment.

2. Geospatial Inspection

FEMA may use geospatial inspections to verify losses. Geospatial inspections can be instrumental in FEMA’s ability to quickly determine eligibility for a large number of communities and expedite delivery of initial assistance to eligible applicants.

FEMA uses a variety of techniques and technologies to conduct geospatial inspections. This includes using aerial and satellite photography and remote sensing technologies. FEMA’s evaluation of pre-disaster data includes information on the area’s demographics and population density, property parcels, building and infrastructure types, and pre-disaster images.



FEMA inspectors use an airplane to inspect homes damaged by flooding in remote Alaskan villages.

3. Documentation of Losses

In some cases, FEMA needs documentation from applicants such as receipts, bills, or estimates to verify losses. Examples of documentation include, but are not limited to:

- Receipts or estimates for medical or dental services, prescriptions, durable medical equipment (DME), assistive technology devices
 - Receipts or contracts for child care services
 - Receipts for moving and storage services
 - Mechanic’s statement, estimate, or receipt for vehicle repair
 - Contractor’s statement, estimate, or receipt for damage to wells, septic, or furnace system
- For additional information on assistance for these losses and documentation requirements, see [Chapter 3, VI](#).

C. Applicant Communication

FEMA communicates with each applicant throughout the IHP process to gather information, inform them of their eligibility for assistance, refer them to other sources of assistance, and guide them on the proper use of IHP funds.

1. *Written Consent*

FEMA generally communicates directly with each applicant to protect their private information. The Privacy Act requires FEMA to obtain written consent from the applicant in order to share their disaster assistance records with a third party.

The written consent must:

- Be in writing (handwritten or typed);
- Include the applicant's identity verification information (full name, current address, date and place of birth);
- Be dated and signed by the applicant;
- Be notarized or include the statement, "I hereby declare under penalty of perjury that the foregoing is true and correct.";
- Include an individual identifier. Examples are: the FEMA Application Number, current mailing address, current phone number;
- Specify what information can be released to the third party (e.g., the entire case file, the current contact information, the amount of disaster assistance received); and
- Include a third-party designation. The individual must designate the individuals, entities, or organizations to which the disclosure is being consented.

FEMA may accept a Power of Attorney, Guardianship, or Conservatorship documentation from an applicant's assigned third party if it meets the state law requirements where the applicant resides. Since these instruments have different restrictions, authorizations, or purposes than the Privacy Act, the submitted information must be coordinated further for program review and FEMA's Office of Chief Counsel review and validation prior to sharing information or access to the applicant's file with the third party.

2. *Letters*

FEMA also communicates with applicants through electronic notification via email, online through www.disasterassistance.gov, or letters sent through the U.S. Postal Service. If the applicant needs letters in an alternative format or needs assistance understanding the letters, they may contact FEMA's Helpline or visit a DRC. All FEMA letters sent to applicants are written in plain language. Letters may include:

- **Eligibility Notifications:** This letter informs the applicant of the types of assistance FEMA has determined they are eligible or ineligible to receive, the amounts of assistance FEMA is providing for each eligible need, the reasons an applicant is ineligible for the applicable types of assistance, an explanation of the appeals process, and other key information regarding disaster assistance, including proper use of disaster assistance funds.

- **Use of Funds:** Applicants are advised on appropriate use of disaster assistance funds in their notification letter from FEMA. Applicants should document how they used disaster funds and retain these records (e.g., receipts, invoices) for at least three years to ensure they are prepared if FEMA identifies their case for an audit.
- **Appeals Process:** Applicants who disagree with a FEMA eligibility decision may appeal the decision. FEMA reviews the applicant's written appeal and documentation received from the applicant supporting the appeal. Upon review, FEMA either provides a written decision to the applicant or requests more information from the applicant. If FEMA upholds a decision on an appeal, FEMA's decision is considered final and will generally not be reconsidered.
- **Request for Information:** If FEMA requires more information to process an applicant's request, an applicant may receive a letter requesting additional information.

3. *Insular and Remote Areas*

FEMA has unique considerations for delivering Federal assistance in insular areas (i.e., Guam, the Commonwealth of the Northern Mariana Islands, American Samoa, and the U.S. Virgin Islands) or otherwise remote areas such as the interior of Alaska. In some cases, the lack of building materials and skilled local labor, high transportation costs, and/or subsistence lifestyles require tailoring FEMA program delivery. FEMA works to immediately identify any potential obstacles to effectively deliver IHP assistance and determine what guidelines or procedures may need to be modified based on the needs of the impacted area.



A FEMA inspector with a disaster survivor surveying damage from severe flooding and ice jams in the remote areas of the Koyukuk River, Alaska.

Depending on the situation, FEMA may:

- Develop alternate means of identifying properties (e.g., using Global Positioning System coordinates if the area does not have or use a street naming or numbering system).
- Deploy registration and inspection teams to enable FEMA to gather information and verify losses in areas with unique logistical requirements.
- Consider additional personal property items necessary for climate-appropriate survival in insular areas, in coordination with the STT government. These items may include detached communal cooking facilities, food caches, smoke houses, or steam bath houses.
- Manually review applicant cases to determine eligibility instead of using an automated process. A manual determination process can better accommodate unique situations falling outside of standard IHP guidelines (e.g., verifying property ownership based on local official statements in areas where properties are handed down to families and few written records exist).
- Provide FEMA disaster assistance for increased shipping costs of materials to insular areas in order to make repair or replacement feasible.

4. Tribal Governments

FEMA recognizes the sovereign rights, authority, and unique status of tribal governments and is committed to working in partnership with tribal governments on a nation-to-nation basis. Tribal government refers to any Native American tribe, band, nation, pueblo, village, or community in the continental U.S. and Alaska that is listed as a tribe under the Federally Recognized Native American Tribe List Act of 1994.

Federally-recognized tribal governments may choose to request a disaster declaration from the President directly or be considered as part of their respective state's declaration request. Additionally, tribal governments may choose to receive one form of assistance (i.e., IA, PA, and HMGP) under a state declaration and another form of assistance through a direct disaster declaration as long as the assistance programs are different and there is no duplication of benefits. IA cost share⁸⁹ and other regulations apply for tribal governments as they do for state governments.



Tribal village members gather at a local school to register with FEMA.

FEMA works closely with the tribal government's assigned representatives to immediately identify issues and potential obstacles and determine what standard guidelines or procedures may need to be modified based on the needs of the impacted area.

Depending on the needs of the tribal government, FEMA may use alternative processes, services, and tools—such as those described above for insular and remote areas—to better serve and ensure expedited access to FEMA programs and assistance.

Overall, FEMA assists and coordinates with the tribal governments in accordance with the following principles:

- Consult with the tribal governments before taking a proposed FEMA action that would have a substantial direct effect on one or more tribes, the relationship between the Federal government and tribes, or the distribution of power and responsibilities between the Federal government and tribes.
- Evaluate the impact of policies, programs, and activities on tribal trust resources and consider the rights and concerns of tribal governments in its decision-making, including impacts on individuals with disabilities and others with access and functional needs.
- Assist tribal governments, should they seek assistance, in setting priorities for the interests of their community members as related to FEMA programs.



Members of the Shingle Springs Band of Miwok Indians hosted the California Tribal Historic Preservation Officers State Historic Preservation Summit.

IV. Housing Assistance (Financial)

The Housing Assistance provision of the IHP, authorized by Section 408(c) of the Stafford Act, provides financial and direct assistance for disaster-caused housing needs not covered by insurance or provided by any other source. Financial Housing Assistance refers to funds provided to eligible applicants for temporary lodging expenses, rental of temporary housing, or repair or replacement of a damaged primary residence.



A road is severely damaged by flooding in Manitou Spring, Colorado, 2013.

FEMA assistance may be provided when the disaster has caused damage that affects the habitability of the home. FEMA defines “uninhabitable” as a dwelling that is not safe, sanitary, or fit to occupy. “Safe” refers to being secure from disaster-caused hazards or threats to occupants and “sanitary” refers to being free of disaster-caused health hazards. FEMA also requires that disaster-damaged components were functional prior to the disaster. “Functional” refers to an item or home capable of being used for its intended purpose.⁹⁰ Applicants may provide FEMA with documentation about their disabilities that could potentially impact the habitability determination.

In addition, the applicant must agree to return funds to FEMA when the assistance provided by FEMA duplicates assistance from another source, was provided in error, was spent on expenses inappropriately, or was obtained through fraudulent means.

A. Lodging Expense Reimbursement

FEMA may provide LER for applicants who incur out-of-pocket temporary lodging expenses⁹¹ due to damage that affects the habitability of their primary residence as a result of a Presidentially-declared disaster.⁹² Eligible lodging expenses may include the cost of the room and taxes charged by a hotel or other lodging provider. As a type of Temporary Housing Assistance, LER does not count toward the financial Housing Assistance maximum award an applicant may receive (see [Chapter 3, I](#)).



Lodging Expenses

Lodging expense means expenses for reasonable short-term accommodations that individuals or households incur in the immediate aftermath of a disaster.

1. Conditions of Eligibility

LER may be awarded from the start date of the incident, up to and not to exceed seven days from the approved date of any initial Rental Assistance ([Chapter 3, IV.B.](#)) award, unless FEMA authorizes an extension. In addition to general conditions of eligibility (see [Chapter 3, II.](#)), applicants must meet the following conditions in order to receive LER:

- FEMA verifies, as a result of the disaster, the pre-disaster residence is:
 - Uninhabitable, meaning the dwelling is not safe, sanitary, or fit to occupy,⁹³ or requires repairs to make the residence habitable; or
 - Inaccessible, meaning the applicant's disaster-damaged primary residence cannot be entered due to access impediments (e.g., fallen trees, downed power lines, damaged access ramps) or restrictions placed by Federal, SLTT government officials.

- The applicant incurred temporary lodging expenses on or after the incident period start date.
- The applicant is not covered by insurance (e.g., Additional Living Expense [ALE], Loss of Use [LOU] coverage) or has insufficient insurance coverage to meet their temporary lodging needs.
- The applicant has not received lodging assistance from any other source (e.g., voluntary organization, etc.) for the same dates the applicant is requesting LER.

2. Required Documentation

To be considered for LER, applicants must submit verifiable lodging receipts or itemized statements, including:

- The applicant or co-applicant's name
- The name, address, and phone number of the accommodation
- Dates of occupancy
- The amount of expenses incurred



Acceptable Lodging Receipts

FEMA may accept lodging receipts in the name of an individual not listed as a household member if the applicant submits proof they have reimbursed the third party for the charges.

Appropriate documentation may include a copy of the canceled check or receipt for the reimbursement of the charges made.

3. Limitations and Exclusions

- LER does not include costs associated with:
 - Phone
 - Laundry
 - Internet
 - Movies
 - Food
 - Pet charges
- Lodging expenses incurred while residing at the home of family or friends will not be reimbursed.
- FEMA will not reimburse lodging expenses for dates an applicant was receiving Transitional Sheltering Assistance. (see [Chapter 2, IX.](#))
- Expenses incurred during mandatory evacuation will not be reimbursed unless an inspection reports the applicant's home as uninhabitable, inaccessible, or affected by an extended disaster-caused utility outage.
- For applicants affected by inaccessibility or utility outage, LER is limited to the dates their residence was inaccessible or had an extended utility outage.
- For applicants whose primary residence is determined uninhabitable who do not choose to relocate, LER is limited to the period from the incident date to the inspection date when the applicant states they do not intend to relocate and are ineligible for Rental

Assistance.

B. Rental Assistance

FEMA may provide financial assistance to pre-disaster homeowners or renters to rent alternate temporary housing if they are displaced from their primary residence as a result of a Presidentially-declared disaster.⁹⁴

FEMA awards eligible applicants initial Rental Assistance based on the Fair Market Rent (FMR)⁹⁵ established by HUD for the county, parish, tribal land, municipality, village, or district where the pre-disaster residence is located and the number of bedrooms the household requires.⁹⁶

Rental Assistance is intended to cover the monthly rent amount (including lot rent, if applicable) and cost of essential utilities (i.e., gas, electric, water, oil, trash, and sewer), excluding telephone, cable, TV, or internet service for the housing unit.⁹⁷

FEMA may provide Rental Assistance, including initial and continued assistance awards, up to 18 months or the end of the 18-month period of assistance, whichever comes first. FEMA will also award applicants one additional month of rent when utilized for a security deposit. If the 18-month financial period of assistance is extended, the number of eligible months of Rental Assistance will also be extended.

Figure 18. FEMA Rental Assistance Overview

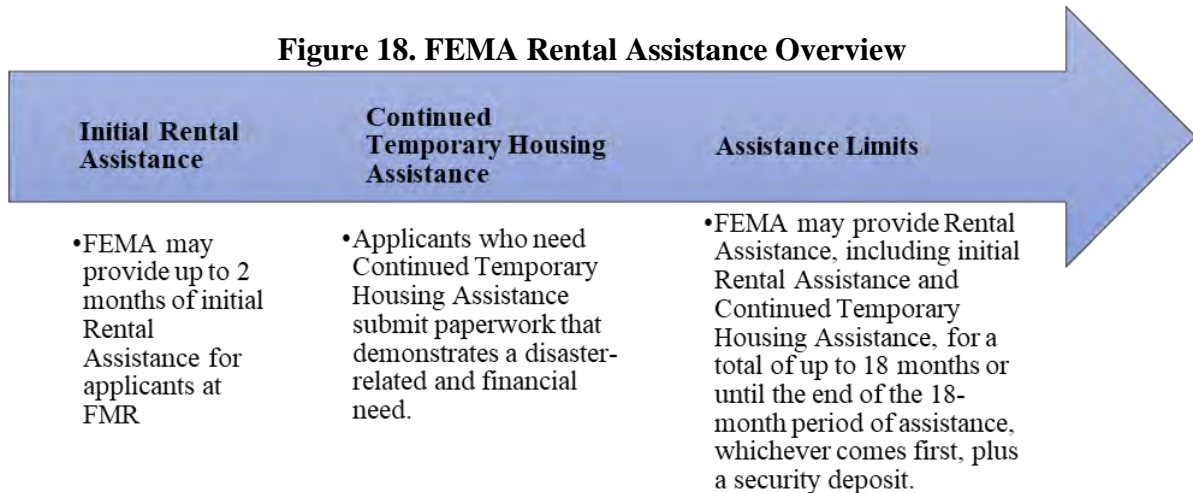

As a type of Temporary Housing Assistance, Rental Assistance does not count toward the financial Housing Assistance maximum award.

1. Conditions of Eligibility

In addition to meeting general conditions of eligibility (see [Chapter 3, II](#)), applicants must meet the following conditions in order to receive Rental Assistance:

- FEMA verifies, as a result of the disaster, the pre-disaster residence is:
 - Uninhabitable and requires repairs to make the residence habitable; or
 - Inaccessible and cannot be entered due to access impediments (e.g., fallen trees, downed power lines, damaged access ramps) or restrictions placed by Federal, SLTT government officials; or
 - Affected by utility outages that disrupt functionality of the residence; or
 - Unavailable due to forced relocation, such as the property owner restricting access to the property due to disaster damage or the owner taking possession of the

property for their own disaster housing.

- Applicant is not insured or has insufficient coverage to meet temporary housing needs (e.g., ALE, LOU coverage).
- Applicant is willing to relocate while repairs are being made to their pre-disaster residence. FEMA will not provide Rental Assistance to applicants who choose not to relocate.
- Applicant does not have access to adequate rent-free housing, or own a secondary or vacation home⁹⁸ within a reasonable commuting distance⁹⁹, or own an available rental property that meets their temporary housing needs.¹⁰⁰

FEMA generally provides only one Rental Assistance award per household to assist all members of the pre-disaster household. FEMA will provide assistance to rent one housing unit per application, unless the size or nature of the applicant's household requires assistance to rent more than one housing unit (see [Chapter 3, II](#)).¹⁰¹

C. Continued Temporary Housing Assistance

FEMA may provide Continued Temporary Housing Assistance to eligible applicants based on need and generally only when adequate, alternate housing is not available, or when the applicant's permanent housing plan has not been fulfilled through no fault of the applicant.¹⁰² The continued temporary housing need must be documented and the applicant must continue to work toward obtaining permanent housing to remain eligible for Continued Temporary Housing Assistance.

FEMA generally expects that pre-disaster renters will use their initial Rental Assistance to obtain permanent housing¹⁰³ and that all recipients of financial assistance will obtain and occupy permanent housing at the earliest possible time.

Continued Temporary Housing Assistance is based on the HUD FMR for the county, parish, tribal land, municipality, village, or district in which the post-disaster housing unit is located. Award amounts are based on actual rent costs plus a utility allowance determined by HUD, not to exceed the HUD FMR unless a Rental Assistance rate increase has been authorized.¹⁰⁴

As a type of Temporary Housing Assistance, Continued Temporary Housing Assistance does not count toward the financial Housing Assistance maximum award. FEMA may provide Temporary Housing Assistance up to 18 months or the end of the 18-month period of assistance, whichever comes first, plus one additional month of rent when utilized for a security deposit. Initial Rental Assistance and Continued Temporary Housing Assistance count toward the 18-month limit. If the 18-month financial period of assistance is extended, the number of eligible months of Rental Assistance will also be extended.



Reasonable Commuting Distance

Reasonable commuting distance means a distance that does not place undue hardship on an applicant. It also takes into consideration travel time involved due to road conditions (e.g., mountainous regions or bridges out) and the normal commuting patterns of the area.



Permanent Housing Plan

Permanent housing plan means a realistic plan that within a reasonable time frame, puts the disaster survivor back into permanent housing that is similar to the pre-disaster housing situation. A reasonable time frame includes sufficient time for securing funds, locating a permanent dwelling, and moving into the dwelling.

1. Conditions of Eligibility

Applicants must meet the following conditions to receive Continued Temporary Housing Assistance:

- Applicant was awarded initial Rental Assistance.
- Applicant exhausted previously awarded Rental Assistance for its intended use.
- Applicant is unable to return to their pre-disaster residence because it is uninhabitable, inaccessible, or not available due to the disaster.
- Applicant does not have the financial ability to obtain housing without assistance.¹⁰⁵
- Applicant is not receiving assistance from any other source for temporary housing.



Maximum Rental Assistance

The maximum amount of Continued Temporary Housing Assistance available under IHP is 18 months of assistance plus the security deposit.

If the 18-month financial period of assistance is extended, the number of eligible months of Rental Assistance will also be extended.

2. Required Documentation

Applicants in need of Continued Temporary Housing Assistance may request additional assistance by completing *FEMA Form FF-104-FY-21-115: Application for Continued Temporary Housing Assistance* (see *Figure 19* for an excerpt of the form), and return it to FEMA along with supporting documentation.¹⁰⁶ The form can also be found online by searching on www.FEMA.gov.

- **Homeowners:** if the applicant's FEMA-verified Real Property Loss exceeds the amount of initial Rental Assistance awarded, the *Application for Continued Temporary Housing Assistance* will automatically be mailed after the initial Rental Assistance award.
 - If the recorded FEMA-verified Real Property Loss does not exceed the amount of initial Rental Assistance awarded, the applicant must call FEMA's Helpline to request an *Application for Continued Temporary Housing Assistance*.
- **Renters:** the applicant must call FEMA's Helpline to request an *Application for Continued Temporary Housing Assistance*.

FEMA uses the information collected on *Application for Continued Temporary Housing Assistance* to verify an applicant continues to have a disaster-caused need for Continued Temporary Housing Assistance and determine how much Rental Assistance the applicant may be eligible to receive.



A FEMA Program Specialist provides service to a flood survivor in Melbourne, FL.

Figure 19: Excerpt of FEMA Form FF-104-FY-21-115: Application for Continued Temporary Housing Assistance

DEPARTMENT OF HOMELAND SECURITY
Federal Emergency Management Agency

OMB No. 1660-0061
Expires January 31, 2024

**INDIVIDUALS AND HOUSEHOLDS PROGRAM
APPLICATION FOR CONTINUED TEMPORARY HOUSING ASSISTANCE**

Instructions for Completing Your Application for Continued Temporary Housing Assistance

Please read these instructions prior to filling out your "Application for Continued Temporary Housing Assistance".

STEP ONE: Fill out the form. **NOTE:** After your initial "Application for Continued Temporary Housing Assistance" is approved, the "Pre-Disaster or Prior Reported" column on the form will be filled-in for you, using the information provided by you in your previously approved request.

Items 1-6

Items 1 through 6 will be filled-in for you, using the information provided by you at registration. If the information supplied on the form is correct, you may move on to Item 7: "Housing Costs." However, if the information is incorrect, please check the box that is incorrect and provide the updated information.

Current Mailing Address is the address you want FEMA to send you disaster assistance information, such as letters regarding your eligibility for continued temporary housing assistance.

Current Phone is the phone number that FEMA can use to contact you about your application for continued temporary housing assistance and other disaster assistance.

Item 7

You will need to supply the dollar amount of both pre-disaster and current expenses that are applicable to your household.

Next to the appropriate "Expense" enter the dollar amount of your bill or payment.

You must submit a copy of each document to prove the dollar amount included as a "Housing Cost." This would include documents such as your mortgage statement, rent receipts and utility bills. Shade in the circle next to the "Expense" indicating that you have attached the document to your application. You must submit documentation that can be verified; otherwise the amount will not be accepted.

Under "Payment Cycle", shade in the circle indicating how you are billed for the housing expense.

7. Housing Costs (See Instructions for Definitions of Expenses)								
Expense	Pre Disaster or Prior Reported	Current	Shade if Document is Attached	Payment Cycle (How You Are Billed)				
				Monthly (1)	Quarterly (4)	Bi-Annual (6)	Annual (12)	Other
Mortgage	\$1495.00	\$1495.00	<input checked="" type="radio"/>	<input checked="" type="radio"/>	<input type="radio"/>	<input type="radio"/>	<input type="radio"/>	<input type="radio"/>

Definitions for certain expenses have been provided below.

Home Insurance means typical homeowners, renters, flood, or earthquake insurance policy or any other type of insurance policy or rider for the dwelling.

Housing Cost means the rent and/or mortgage payments (including principal, interest, and real estate taxes), real property insurance, and utility costs (not to include cable television, internet, and telephone service).

Housing Unit means a house, apartment, a manufactured home, recreational vehicle, or other readily fabricated dwelling. A room or group of rooms in an occupied dwelling may qualify as a housing unit if the room(s) in which the applicant and household live are separate from any other persons in the dwelling/building, and are generally available to be rented by the public.

Item 8

In addition to providing a copy of your written and signed lease, you will have to provide the name and phone number of the landlord. The lease must be signed by the applicant or co-applicant and the landlord.

QUESTIONS OR NEED ASSISTANCE?

If you have any questions about completing this document, you should call the FEMA Disaster Helpline at 1-800-821-FEMA (3362) (hearing/speech impaired only: 1-800-462-7585) as soon as possible.

Figure 20 lists supporting documentation that must be submitted to FEMA, as outlined in the *Application for Continued Temporary Housing Assistance*.¹⁰⁷

Figure 20: Continued Temporary Housing Assistance Documentation

Type of Documentation	Description of Documentation
Copy of current lease or rental agreement signed by the landlord and tenant	The lease or rental agreement should include location of the unit, amount of rent, duration of lease, and number of occupants.
Proof of prior Rental Assistance provided by FEMA has been used for temporary housing	<ul style="list-style-type: none"> • Rent receipts showing date, location of rental unit, and time period for which the payment applies. • If separate from the rent, receipts showing payment of essential utilities. Essential utilities are gas, electric, water, oil, trash, and sewer. • If applicable, receipt showing payment of security deposit for up to one month’s rent. • In instances where rent receipts are not available, the lease or rental agreement may serve as proof of use of prior Rental Assistance. • Hotel/motel receipts showing date, address of hotel/motel, and time period for which payment applies. Only the cost of the room and taxes charged by the hotel will be considered toward acceptable exhaustion of Rental Assistance.
Proof of pre-disaster housing costs, as identified on the <i>Application for Continued Temporary Housing Assistance</i>	<ul style="list-style-type: none"> • Mortgage statement or lease/rental agreement for the disaster-damaged primary residence. • Real estate tax statement and homeowners or renters’ insurance statement, if paid separately from the mortgage. • Essential utility bill(s) for the disaster-damaged primary residence: gas, electric, oil, trash, water, and sewer.
Proof of pre-disaster and current post-disaster income for all members of the household 18 years and older	<p>Examples include, but are not limited to:</p> <ul style="list-style-type: none"> • Recent pay stubs. • W-2 forms or tax returns from most recent tax year. • Documentation of self-employment, if applicable. • Documentation of government assistance, including Social Security.

Upon subsequent requests for Continued Temporary Housing Assistance, applicants will only be required to submit supporting documentation if the household’s income or rent has changed.

3. Limitations and Exclusions

- Applicants must request Continued Temporary Housing Assistance within the period of assistance.
- When an applicant first requests Continued Temporary Housing Assistance and submits documentation that does not demonstrate full exhaustion of the initial Rental Assistance award, the first Continued Temporary Housing Assistance award will be reduced by the remaining amount of initial Rental Assistance.
- Applicants residing in non-traditional housing are not eligible for Continued Temporary Housing Assistance.

D. Rental Assistance Rate Increase

FEMA evaluates the need for a Rental Assistance rate increase by comparing U.S. Census Bureau American Community Survey statistics on housing inventory and vacancy rates to the best available data on disaster-caused housing impacts in declared disaster areas.

The STT government may request a Rental Assistance rate increase by submitting other reliable sources of these data elements for FEMA to use. The FMR Calculator allows FEMA to rapidly evaluate the need for a Rental Assistance rate increase based on pre-disaster housing stock data, the amount of housing impacted by the disaster, and the post-disaster vacancy rate for each impacted county.

FEMA may authorize Rental Assistance rate increases when the FMR Calculator demonstrates available housing for the area is insufficient to meet the disaster-caused housing need, or when elevated housing market rates adversely impact eligible applicants' ability to obtain rental resources.

The Regional Administrator (RA) or the Federal Coordinating Officer (FCO), if the RA has delegated authority to the FCO, may approve Rental Assistance rate increases for designated counties (or equivalent) when the FMR Calculator result indicates an increase above 100%. The increase may not exceed the amount indicated by the FMR Calculator, or 125% of the HUD FMR, whichever is lower. The RA or FCO must provide a written notification of the Rental Assistance rate increase and a copy of the FMR Calculator to the IADD.

The IADD may authorize Rental Assistance rate increases above 125% of the HUD FMR for individual counties (or equivalent) when the FMR Calculator indicates an increase to 125% of the published FMR and additional justification demonstrates a further increase is needed to meet the disaster-caused housing need. Only the IADD may authorize statewide Rental Assistance rate increases. The IADD may approve Rental Assistance rate increases for undeclared areas when housing availability is demonstrated to be insufficient to meet the disaster-caused housing need or when elevated housing market rates adversely impact eligible applicants' ability to obtain rental resources.

FEMA only applies Rental Assistance rate increases to Continued Temporary Housing Assistance awards. If an applicant relocates to a temporary housing unit outside of the area approved for a Rental Assistance rate increase, they are no longer eligible for Continued Temporary Housing Assistance awards above the published HUD FMR.

E. Home Repair Assistance

FEMA may provide financial assistance to repair an owner-occupied primary residence, utilities, and residential infrastructure, including private access routes damaged as a result of a Presidentially-declared disaster up to the financial Housing Assistance maximum award.¹⁰⁸ Home Repair Assistance is intended to make the damaged home safe, sanitary, or functional. It is not intended to return the home to its pre-disaster condition. Home Repair Assistance counts towards the financial Housing Assistance maximum award an applicant may receive (see [Chapter 3, I](#)).



Pre-Disaster HUD Applications

Prior to reviewing a pre-disaster HUD applicant's file for Continued Temporary Housing Assistance, FEMA will coordinate with HUD to determine if the pre-disaster housing unit is available to the applicant. Once the pre-disaster housing unit is available, or HUD is able to provide housing, FEMA will stop providing Continued Temporary Housing Assistance.

Home Repair Assistance for specific disaster-damaged accessibility items is not limited by a financial maximum award. The following accessibility items are eligible under Home Repair Assistance:

- Access ramp
- Grab bars

FEMA may provide financial assistance for the repair of real property components, including, but not limited to:

- Structural components of a home (e.g., foundation, exterior walls, roof)
- Windows, doors, floors, walls, ceilings, and cabinetry
- Heating, ventilation, and air conditioning system (HVAC)
- Access and egress, including privately-owned roads, privately-owned bridges, and privately-owned docks
- Blocking, leveling, and anchoring of a mobile home, and reconnecting or resetting its sewer, water, electrical, oil, and fuel lines and tanks
- Line items to restore a houseboat to a habitable state, not necessarily to return the houseboat to seaworthiness
- Utility systems, including electrical, gas, water, oil, and septic/sewage systems



Wells, Furnaces, and Septic Systems

For wells, furnaces, and septic systems, FEMA may provide assistance or reimbursement for the cost of a licensed technician’s professional assessment associated with the repair or replacement of those components.

Additionally, when verifiable receipts or estimates are submitted on appeal, FEMA may pay up to the actual cost of the receipt or estimate for wells, furnaces, and septic systems.

Certain items or services determined to be eligible hazard mitigation measures, which reduce the likelihood of future damage to the residence, utilities, or infrastructure, may be eligible for Home Repair Assistance.

Figure 21 shows examples of disaster-caused damage that may be eligible for Home Repair Assistance, and also damage not covered by FEMA’s IHP, and therefore, not eligible for Home Repair Assistance.

Figure 21: Types of Potentially Eligible Disaster-Caused Home Damage	
<i>May be eligible for Home Repair Assistance:</i>	<i>Not eligible for Home Repair Assistance:</i>
Roof	Garage
Windows	Pool
Foundation	Fences
Walls	Landscaping

1. Conditions of Eligibility

In addition to meeting general conditions of eligibility (see [Chapter 3, II](#)), the following conditions must be met to receive Home Repair Assistance:

- A FEMA inspection determines the repair of the component is necessary to ensure the safety or health of the occupant or to make the component or residence functional.
- The real property components were functional immediately before the declared disaster.
- The component was damaged, and the damage was caused by the disaster.
- The damage to the component is not covered by insurance.



Components

Components or residences that were fully or partially functional immediately before the declared disaster, despite their need for maintenance, may be eligible for Home Repair Assistance if they ceased to function as a result of the disaster.

2. Limitations and Exclusions

- Hazard mitigation may be awarded as part of Home Repair Assistance for real property components that existed, and were functional, prior to the disaster.
- Home Repair Assistance is not available for non-traditional forms of housing (e.g., tents and certain types of huts and lean-to structures).
- Home Repair Assistance is not available to landlords who do not permanently reside in the damaged dwelling. In addition, any available assistance is limited to the owner-occupied unit and not common areas.
- Applicants whose pre-disaster residence was a houseboat will not be required to obtain and maintain flood insurance for NFIP-insurable items, as these structures are uninsurable under NFIP.
- An applicant with insurance for a covered peril will be ineligible for Home Repair Assistance for insured real property components when the applicant fails to file a claim with their insurance company.
- Home Repair Assistance for flood-damaged real property in basements is limited to damaged items that result in living conditions affecting the safety, sanitation, and functionality of the home.¹⁰⁹



Basements

FEMA defines a basement as an area of the home with its floor below grade (below ground level) on all sides.

Disaster-caused damage in a basement affecting the safety, sanitation, and functionality of the home may include:

- Damage to the structural components (e.g., foundation) of the home
 - Damage to critical utilities that support the overall function of the home (e.g., furnace, water heater)
 - Damage to the structure's interior (e.g., doors, floor covering); limited to rooms required for the occupancy of the dwelling (e.g., occupied bedrooms, a bathroom required for the occupied bedroom, a sole kitchen or living room); and no other room in another part of the dwelling meets that need
 - Damage presenting a hazard (e.g., wet or moldy drywall, carpet, or cabinets) in non-essential living areas (for removal only)
- Home Repair Assistance award amounts are based on repair or replacement of components that are of average quality, size, or capacity.
 - Home Repair Assistance will not be provided to make improvements to a component's pre-disaster condition unless required by current SLTT government building codes or ordinances, similar products are no longer feasible or available in the marketplace, or for reasonable hazard mitigation measures.

F. Privately-Owned Access Routes

FEMA may provide financial assistance to repair privately-owned access routes (i.e., driveways, roads, or bridges) damaged as a result of a Presidentially-declared disaster.¹¹⁰ Assistance for privately-owned access routes is intended to restore access to the owner's primary residence. In instances where multiple households share a privately-owned access route, assistance is shared between applicants, requiring additional coordination and documentation between FEMA and the applicants.

1. Conditions of Eligibility

In addition to meeting general conditions of eligibility (see [Chapter 3, II.](#)), the following conditions must be met to receive Home Repair Assistance for privately-owned access routes:

- A FEMA inspection determines repairs are necessary to provide drivable access to the primary residence.
- The applicant is responsible (or shares responsibility with other homeowners) for maintaining the privately-owned access route to their primary residence.
- The privately-owned access route is the only access to the applicant's primary residence or repair or replacement of a secondary route is necessary for practical use (e.g., it is impossible to access the residence without a bridge or road) or the safety of the occupants or the residence would be adversely affected because SLTT government emergency equipment could not reach the residence.
- Docks only:
 - A FEMA inspection will be required to determine whether the dock was functional prior to the Presidentially-declared disaster and whether repair is necessary.
 - The dock must be the applicant's sole means to access the primary residence.
 - Dock maintenance and repairs must be the applicant's responsibility.
- If multiple households share the access route, FEMA also requires:
 - Written consent from all applicants as pertains to the shared privately-owned access route.
 - A declarative statement affirming any assistance FEMA provides will be used to make repairs to the access route and the applicant understands they are responsible for securing permits and complying with local codes and ordinances.
 - The applicants do not have an established Homeowner's Association or Covenant responsible for repair of the access route, or the established Homeowner's Association or Covenant is unable to receive assistance from the SBA or private insurance to repair the access route.



Privately-Owned Access Route

If multiple households use a privately-owned access route, FEMA will make several attempts to encourage all households to apply for assistance in order to meet the needs of all affected households. Additionally, access of emergency vehicles should only be considered if access was available prior to the disaster.

2. *Limitations and Exclusions*

- FEMA will provide other types of IHP assistance before considering providing Home Repair Assistance for an applicant’s private access route.
 - For eligible applicants who have sole responsibility to repair the access route to their home, FEMA will provide Rental Assistance, then consider eligibility for Home Repair Assistance for an applicant’s private access route.
 - For eligible applicants who share responsibility with other eligible applicants to repair the access route, FEMA will provide Rental Assistance, Home Repair Assistance for items that do not affect the access route, ONA, then consider eligibility for Home Repair Assistance for an applicant’s private access route.
- The Home Repair Assistance award amount is based on repair items (e.g., decking, guardrails, and handrails) that are of average quality, size, and capacity.
 - Repair awards will not include improvements to the access route’s pre-disaster condition unless improvements are required by current SLTT government building codes or ordinances.
 - An applicant with access and functional needs that requires access for a particular vehicle may be approved for additional funds to improve the access if required for safe passage.
- FEMA will verify whether the SLTT government has taken or plans to take any emergency actions to repair the route to provide access for emergency service providers or to remove immediate threats to public health and safety. Eligible activities for the repair of privately-owned access routes are subject to Federal Environmental Planning and Historic Preservation (EHP) compliance review requirements.
 - Eligible applicants are responsible for complying with any conditions developed as a result of the EHP compliance review process and for obtaining any applicable Federal or SLTT government permits prior to conducting work.
- If multiple families share an access route, individuals who do not apply or do not meet all eligibility requirements will not receive assistance and will not be considered when determining the amount an eligible applicant will receive.



EHP Compliance Review

The EHP compliance review process considers the effects of Federal funding on resources such as endangered species, floodplains and wetlands, and historic properties. FEMA is required to ensure that Federal funding complies with applicable Federal EHP laws, regulations, and executive orders (EOs) prior to providing assistance.

G. Home Replacement Assistance

FEMA may provide financial assistance to owners whose primary residences were destroyed as a result of a Presidentially-declared disaster. Home Replacement Assistance may be applied toward purchasing a new permanent residence even if the new residence's cost is greater than the financial Housing Assistance maximum award.

FEMA calculates the replacement award amount according to the consumer price index data for the types of housing in the area where the damage occurred. FEMA establishes award amounts based on whether the pre-disaster home was a manufactured home, travel trailer, houseboat, or residential construction (e.g., single-family home). However, the award amount cannot exceed the financial Housing Assistance maximum award (see [Chapter 3, I.](#)).

1. Conditions of Eligibility

In order to qualify for Home Replacement Assistance, applicants must meet general conditions of eligibility (see [Chapter 3, II.](#)) and the following:

- The residence was functional immediately before the disaster.
- A FEMA inspection confirms the residence was destroyed, and the damage was caused by the disaster. FEMA considers a residence destroyed when:
 - Disaster-caused damage necessitates the replacement of the majority of two or more major structural components (e.g., basement walls/foundation, load-bearing walls, or roof assembly have collapsed);
 - The disaster has completely removed the above-grade structure and only the foundation remains;
 - Flood waters have reached the roof, inundating the majority of the structure's living area;
 - The dwelling is in imminent threat of collapse because of disaster-caused damages;
 - In the case of mobile homes and or travel trailers, when the frame is visibly bent or twisted and releveling is not possible; or
 - Repair is not feasible, and replacement is necessary to ensure the safety or health of the occupant or make the residence functional.
- The damage to the residence is not covered by insurance.



Functional

Functional means a “component” or residence capable of being used for its intended purpose, or an item or home capable of being used for its intended purpose.

2. Limitations and Exclusions

- Home Replacement Assistance is not available for non-traditional forms of housing (e.g., tents, certain types of huts, and lean-to structures).
- Home Replacement Assistance is not available for other residence types (e.g., yurts and shipping containers or railroad cars converted into living quarters).
- Home Replacement Assistance is not available to landlords who do not permanently reside in the damaged dwelling. In addition, any available assistance is limited to the owner-occupied unit and not common areas.

3. Appeal Considerations

If FEMA determines the residence was not destroyed by the disaster, the applicant may appeal by submitting supporting documentation from governing authorities giving notice of condemnation, substantial damage, or demolition.

- FEMA will not automatically determine an applicant eligible for Home Replacement Assistance based on submitted documentation, because local authority determinations could be based on non-disaster-caused circumstances.
- After receiving appeal documentation from the applicant, FEMA will review the request to determine if another inspection is necessary in order to verify if the residence was destroyed due to disaster-caused damage.

V. Housing Assistance (Direct)

The Housing Assistance provision of the IHP, authorized by Section 408(c) of the Stafford Act, provides assistance for disaster-caused housing needs not covered by insurance or provided by any other source. FEMA may provide Direct Housing Assistance in two forms: Direct Temporary Housing Assistance and PHC. These types of assistance do not count toward the financial Housing Assistance maximum award.¹¹¹

FEMA may only provide Direct Temporary Housing Assistance when eligible applicants are unable to use Rental Assistance to secure temporary housing. Direct Temporary Housing Assistance includes providing Temporary Housing Units (THUs) through MLR or Direct Lease, or placing TTHUs on private, commercial, or group sites.¹¹²

FEMA may only provide PHC in insular areas and other locations when other housing options are not available and Temporary Housing Assistance (i.e., Rental Assistance or Direct Temporary Housing Assistance) is not feasible, available, or cost-effective. PHC may be delivered in the form of repairs and new construction.¹¹³

A. Direct Housing Assessment

When there appears to be a lack of available housing resources within the HUD FMR or the approved Rental Assistance rate for the disaster to support the potential need for housing due to the disaster, FEMA will partner with the affected STT government to perform a comprehensive analysis of the disaster-caused housing needs and available resources. This assessment is comprised of local housing information, U.S. Census Bureau American Community Survey Statistics on housing inventory and vacancy rates, registration projections, and other data to determine if the disaster-caused housing needs significantly exceed available resources in declared disaster areas.

For National Response Coordination Center (NRCC) Level 1 events with major disaster declarations authorizing IA (and some Level 2s), the FCO or RA may request a Sheltering and Housing Field Team (SHFT) deploy to provide subject matter expert planning support in addition to the assessment described above. This request will be approved or denied by the IA Division Director. Once the SHFTs are established, rostered teams made up of FEMA HQ and Regional staff will support the JFO staff in outlining a streamlined suite of sheltering and housing solutions as well as case management services that promote effective and efficient housing recovery outcomes. In the event that a SHFT is not deployed, a Sheltering and Housing Strategy should be developed for any disaster where multiple sheltering and housing options may be needed to support the needs of disaster survivors.

FEMA expects states to maintain a State-Led Disaster Housing Task Force (SLDHTF), which will examine the scope of disaster-caused housing needs, to explore available rental resources and feasible alternatives, and to develop housing solutions.



THU and TTHU

Temporary Housing Unit

(THU): A house, apartment, cooperative, condominium, manufactured home, or other dwelling acquired by FEMA and made available to eligible applicants for a limited period of time. The term “THU” includes TTHUs where used in this guidance, except where specifically stated otherwise.

Transportable Temporary Housing Unit

(TTHU): A readily-fabricated dwelling (i.e., a Recreational Vehicle [RV] or Manufactured Housing Unit [MHU]) purchased or leased by FEMA and provided to eligible applicants for use as temporary housing for a limited period of time.

Other duties of the SLDHTF include:

- Coordinating with federal and SLTT government, non-governmental organizations, and private sector expertise to identify, evaluate, and deliver available programs, resources, and capabilities to disaster survivors; and
- Providing federal and non-Federal supported assistance through agencies other than FEMA, including case management, administration of the HUD Community Development Block Grant – Disaster Recovery Program and organization of the mission.

FEMA will coordinate with the SLDHTF to identify all applicable compliance requirements for providing Direct Temporary Housing Assistance, if needed, including Federal, SLTT government ordinances, the currently-adopted building code, zoning, permitting process and requirements, and any impediments and requirements that may impact the delivery of Direct Temporary Housing Assistance. Other related requirements may include:

- SFHA and wetland identification;
- EHP compliance requirements, including those related to any Federally-listed threatened or endangered species and designated critical habitat or historic properties; and
- A comprehensive procurement approach, including market research and independent government cost estimates.

B. Direct Temporary Housing Assistance Request and Approval

FEMA will only authorize Direct Temporary Housing Assistance in response to a written request from the State, Territorial, or Tribal Coordinating Officer (SCO/TCO) or Governor's Authorized Representative (GAR) or Tribal Chief Executive's Authorized Representative (TAR).

FEMA's AA for Recovery has the authority to approve Direct Temporary Housing Assistance and to specify relevant conditions for implementation. The AA for Recovery will evaluate the Direct Temporary Housing Assistance request from the STT government using information obtained from the Sheltering and Housing Strategy and the RA or FCO's/TCO's recommendation and provide approval if all the following have been verified:

- Eligible applicants are unable to make use of Rental Assistance due to a lack of available housing resources.¹¹⁴
- Increasing the Rental Assistance rate to 125% of the HUD FMR will not be sufficient to meet the disaster-caused housing needs.
- Assistance from other providers, including other Federal agencies, STT government, and voluntary organizations is insufficient to meet the disaster-caused temporary housing needs of eligible applicants.

In the event the preceding criteria is verified by the Region and the Disaster Housing Unit (DHU), the AA for Recovery may authorize the Initial Direct Temporary Housing Assistance Approval in the form of TTHUs on private and commercial sites and MLR.

The RA will review the Sheltering and Housing Strategy to determine which forms of Direct Temporary Housing Assistance to implement based on locations and numbers of eligible applicants and the availability, feasibility, and cost-effectiveness of each option. The RA may delegate this authority to the FCO. In addition, the RA may approve the implementation of group site(s) if the approved Direct Temporary Housing Assistance options are not feasible. The RA must notify the AA for Recovery in writing prior to approving and implementing any TTHU Group Site(s).

A separate written request from the FCO to the AA for Recovery is required for the approval of Direct Lease. The request should demonstrate that other forms of housing assistance have been evaluated and delivered in sequential order and are not sufficient to meet the disaster-caused housing need; housing needs exceed the capacity to provide MLR units or TTHUs in a timely manner; and when one or more properties have been identified that meet the criteria identified in the Direct Lease (see Chapter 3, V.G) section of this chapter.

After Direct Temporary Housing Assistance has been approved and the forms of assistance being provided have been determined, the FCO will coordinate with the STT government to execute an addendum to the agreement between FEMA and the STT government that describes the responsibilities of each party. FEMA will use the most cost-effective forms of available Direct Temporary Housing Assistance to meet the disaster-caused housing needs. In general, FEMA, in coordination with the STT government and based on disaster-specific requirements, will prioritize the types of Direct Temporary Housing Assistance as depicted in *Figure 22*.

PHC may be considered when no alternative housing resources are available and all forms of Direct Temporary Housing Assistance are unavailable, infeasible, or not cost-effective.

Figure 22: General Sequence of FEMA Direct Housing Assistance Options

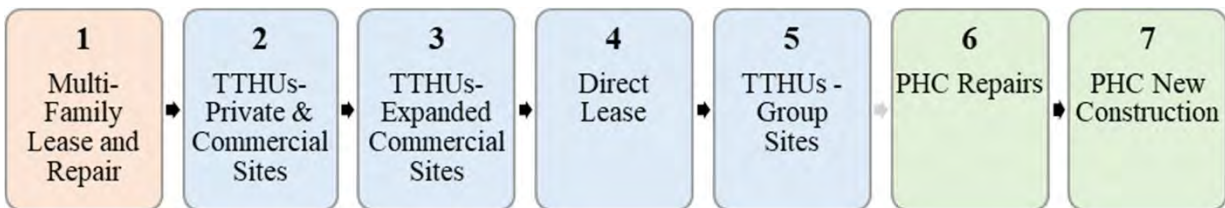

C. Direct Temporary Housing Assistance Conditions of Eligibility

This section describes the additional conditions FEMA uses to determine an applicant’s eligibility for Direct Temporary Housing Assistance and to select the appropriate size and type of THU to meet the household’s needs.



Direct Temporary Housing Assistance

Applicants who are ineligible for Home Repair Assistance or Home Replacement Assistance because they failed to maintain flood insurance required as a condition of accepting financial assistance in a previous disaster may still be eligible for Direct Temporary Housing Assistance.

1. Conditions of Eligibility

Applicants who may be eligible for Direct Temporary Housing Assistance must:

- Meet all the conditions of eligibility found in IHP Eligibility (see [Chapter 3, II.](#)).
- Be verified by FEMA through the on-site inspection conducted following an applicant’s registration as:
 - An owner of a disaster-damaged primary residence with real property verified loss amount of at least \$12 per square foot (see examples in *Figure 23*);¹¹⁵ or
 - A renter with a disaster-damaged primary residence that was destroyed or received major damage as a result of the disaster.

Figure 23: Three examples of the \$12 per square foot Real Property Verified Loss Amount

Square Footage of Disaster-Damaged Primary Residence	Real Property Verified Loss Amount at \$12 per square foot.
<i>Disaster-damaged primary residence sq.ft. X \$12 = FVL</i>	
750 square feet	\$9,000
2,000 square feet	\$24,000
5,000 square feet	\$60,000

- Not be receiving Continued Temporary Housing Assistance and Direct Temporary Housing Assistance for the same months.

Limitations and Exclusions

- Applicants who are receiving Continued Temporary Housing Assistance for a rental resource outside of reasonable commuting distance of their disaster-damaged residence may be considered for Direct Temporary Housing Assistance.

FEMA contacts applicants to obtain information about their household's unmet temporary housing needs. During the contact, typically by phone, FEMA refers eligible applicants to other adequate, accessible, alternate housing units, if available, prior to discussing Direct Temporary Housing Assistance. FEMA expects applicants to accept the first offer of available alternate housing that meets their household's needs; applicants who refuse available housing that meets their household's needs may become ineligible for Direct Temporary Housing Assistance. FEMA determines no housing resources are available or available alternate housing resources are not adequate for the applicant's household because of one of the following:



Recording Property Loss

FEMA inspectors do not record real property losses for renters, as renters are not responsible for repairs to their pre-disaster residence. Therefore, the threshold for renters is based on a general level of damage rather than a specific dollar amount of real property damage.

- Housing resources are not within reasonable commuting distance.
- Housing resources exceed the applicant's financial ability, defined as no more than 30% of the household's income.
- The applicant's household includes children attending school (not including post-secondary education) and transportation to school is not available from any of the available alternate housing resources.
- Housing resources are not accessible to one or more members of the applicant's household who have a disability.
- Housing resources are not in reasonable distance to accessible public transportation and the household includes one or more persons with a disability who requires accessible public transportation.
- The applicant's primary residence is a working agricultural interest generating at least 50% of the household's pre-disaster income.
- A member of the applicant's household needs in-home health care services, or provides such services to a friend, neighbor, or relative, and would be unable to receive or provide these services if relocated to an alternate housing resource.
- The applicant is able to provide verifiable documentation that demonstrates:
 - The landlord or leasing agent will not agree to a lease of less than one year; or
 - The applicant is unable to use Rental Assistance due to adverse credit history or criminal background. However, FEMA will coordinate with voluntary agencies and other organizations to assist in housing applicants in this situation prior to considering Direct Temporary Housing Assistance.

2. Temporary Housing Unit (THU) Selection Considerations

FEMA determines the size of the THU to provide an applicant based on the required number of bedrooms recorded during the FEMA inspection. FEMA generally provides one bedroom for every two persons in the applicant's household.¹¹⁶

- FEMA may provide an additional bedroom based on the age, sex, and relationship of household members or as a reasonable accommodation for a household member with a disability.
- FEMA may provide an additional unit when the size of the applicant's household exceeds the capacity of a single available unit; however, FEMA will not provide more than one unit when the household has only one member over the age of 18.

D. Direct Temporary Housing Assistance Terms and Conditions

FEMA provides Direct Temporary Housing Assistance for up to 18 months from the date of the declaration when adequate, alternate housing is unavailable, and the occupants cannot fulfill their permanent housing plan (PHP) through no fault of their own.

FEMA re-evaluates the occupant's eligibility on a periodic basis through recertification visits, usually monthly, and the Direct Temporary Housing Assistance eligibility for the entire period of assistance is subject to the occupant continuing to meet recertification requirements. All occupants must agree to comply with FEMA's rules, terms, and conditions for occupying the THUs before they move in by signing a Temporary Housing Agreement or Revocable License. The Revocable License documents the applicant's acceptance of government property for temporary housing based on FEMA's terms and conditions included in the license.

Occupants must demonstrate a continued housing assistance need, actively participate in the FEMA recertification process, and show progress towards achieving their PHP to remain eligible to stay in the THU. When applicants fail to comply with FEMA's rules, terms, and conditions, FEMA may terminate their eligibility to remain in the THU.¹¹⁷ Applicants who have been deemed ineligible by FEMA and refuse to vacate the THU will be subject to a monthly penalty fee. If an applicant refuses to surrender possession of the THU, legal and/or other appropriate actions may be taken.¹¹⁸

1. Occupant Responsibilities

All THU primary occupants must sign and abide by the terms and conditions of the Temporary Housing Agreement or Revocable License, which specifies the household's obligations to:



Primary Occupant

Primary Occupant means the applicant, co-applicant, or other household member over the age of 18 who signs the Temporary Housing Agreement or Revocable License. The primary occupant is responsible for any monthly rent or additional charges related to the Temporary Housing Unit.

- Comply with THU Rules of Use, such as maintaining the unit, its furnishings, and the surrounding area in a clean and orderly condition; paying applicable utility charges; and not damaging or making unauthorized modifications to the THU and its contents;
- For THUs not owned by FEMA (i.e., MLR property) or located on sites not owned by FEMA or the occupant (e.g., commercial parks), the occupant will be required to comply with the terms of the owner's lease or terms of use;
- Act to secure adequate, alternate housing at the earliest possible time within the period of assistance;
- Comply with all rules for a group site or commercial park and comply with all relevant local ordinances;
- Refrain from conduct which adversely affects FEMA's property interest in the THU or the rights of other THU occupants to enjoy safe, secure, and functional temporary housing; and
- Meet the recertification requirements identified in continued Direct Temporary Housing Assistance.

FEMA will notify insured THU occupants that DOB may occur if an insured member of their household receives ALE or LOU benefits to rent alternate housing. When this occurs, the primary occupant must:

- Pay an amount equal to the ALE or LOU benefit to FEMA starting from the date the occupant signed the Temporary Housing Agreement or Revocable License. The amount of the monthly DOB payment to FEMA will not exceed FMR; and
- Continue to make the ALE or LOU payment to FEMA until the total amount of the insurance benefit for ALE or LOU has been exhausted or the occupant vacates the THU, whichever is first.

2. Direct Temporary Housing Assistance Recertification

FEMA requires all THU occupants to actively participate in the recertification process. Occupants are responsible for achieving their PHP at the earliest possible time within the period of assistance and providing verifiable information of their progress towards their PHP to FEMA in order to receive continued Direct Temporary Housing Assistance.

FEMA requires the THU primary occupant to establish a realistic PHP for their household no later than the first recertification. An acceptable PHP may demonstrate one of the following:

- A pre-disaster owner is able to repair or rebuild the pre-disaster residence.
- A pre-disaster owner is able to purchase a new residence.
- A pre-disaster owner or renter is able to find and lease an available rental unit.
 - FEMA expects owners who cannot demonstrate the ability to repair or rebuild their pre-disaster residence or purchase a new residence within the period of assistance to move into an available rental resource.

FEMA will regularly review the primary occupant's PHP to ensure the plan is realistic and achievable within the period of assistance. A PHP is realistic and achievable when:

- The primary occupant demonstrates sufficient financial resources or other viable means for achieving the PHP within the period of assistance. Sufficient resources include funds or a verifiable commitment of non-financial assistance, such as voluntary agency labor; and
- The primary occupant shows documented progress towards the PHP (e.g., acquired permits, contracts for repairs).

Primary occupants who have not made progress toward their PHP must demonstrate it is due to no fault of their own (e.g., a contractor failure to obtain the required building permits, or a delay in the rental unit move-in date) and update their PHP to ensure they are realistic within the period of assistance.



Disaster Case Management Program (DCM)

SLTT governments may request the FEMA DCM Program if the Presidential disaster declaration includes IA. DCM provides disaster survivors with a single point of contact to facilitate access to a broad range of resources.

The case manager verifies the survivor's disaster-caused unmet needs, and works with the survivor to develop a goal-oriented plan that outlines the steps necessary to achieve recovery.

The case manager also organizes and coordinates information on available resources that match the survivor's disaster-caused need, monitors progress toward reaching recovery plan goals, and advocates for the survivor as needed. DCM is a critical resource for THU occupants with disaster-caused needs. More information on DCM is available in [Chapter 4](#).

3. Health and Safety Concerns of THU Occupants

When an occupant reports a health and safety concern about the living environment in the THU, FEMA will investigate to identify or verify the cause and obtain professional, expert recommendations for addressing the concern. If this investigation determines that testing and/or remediation is necessary, FEMA may require the occupant to vacate the unit. FEMA may offer alternate accommodations and moving and storage of personal property for occupants displaced due to any THU testing and/or remediation requirements.

4. Extension of Direct Temporary Housing Assistance

FEMA may extend Direct Temporary Housing Assistance beyond the 18-month period of assistance when the affected STT government requests an extension in writing.¹¹⁹ Consistent with the terms and conditions of the FEMA-State/Territory/Tribe Agreement, the affected STT government should request an extension at least 90 days before the end of the current period of assistance. The AA for Recovery will consider the request for approval. When the period of assistance is extended, FEMA will begin monthly rent collection from eligible occupants of FEMA TTHUs.¹²⁰

- FEMA may authorize extensions to the initial 18-month period of assistance due to extraordinary circumstances when doing so is in the public interest.
- FEMA will typically not consider extending the period of assistance without a written request from the SCO/TCO or GAR/TAR. However, FEMA may extend the period of assistance at its sole discretion; extensions to the period of assistance will only be considered in situations where the remaining disaster-caused temporary housing need exceeds the capabilities of the STT government, or the affected communities to support and there remains a lack of available resources. The request should include supporting documents demonstrating this housing need.
- The AA for Recovery may consider extending the period of assistance when:
 - Adequate, alternate housing is not available in the affected area; and
 - Accessible housing units for occupants with disabilities are not available or are not within a reasonable commuting distance of essential services (e.g., accessible public transportation, grocery, medical facilities, banking, child care, schools, or place of employment).
- If an extension is approved, the affected STT government must execute an amendment to the FEMA-State/Territory/Tribe Agreement .

5. Rent Collection for FEMA Temporary Housing Unit

After the period of assistance has been extended, FEMA charges the primary occupant a monthly rent for each month any occupant remains in or maintains possession of a THU.¹²¹ The monthly THU rent is based on the locally applicable FMR.

Establishing Rent Amount: FEMA calculates each occupant’s monthly rent by applying the FMR based on the number of bedrooms in the THU and the THU location for the fiscal year in which Direct Housing Assistance is extended. Monthly rent begins accruing on the first day of the first full month after the extended assistance period begins.¹²² The primary occupant will be required to pay monthly rent due on the first day of each month after the date rent begins to accrue.¹²³

Prior to the end of the period of assistance, FEMA provides a 30-day written notice of the requirement to pay monthly rent to occupants who remain in a FEMA THU after the initial 18-month period of assistance.

FEMA does not prorate rent or reimburse the primary occupant when any occupant remains in or maintains possession of the THU on or after the first day of the month. If any occupant remains in the THU on or after the first day of the month, the primary occupant is required to pay full rent for that month.



Extra Bedroom

If FEMA provided the occupant with an extra bedroom as a reasonable accommodation, the extra bedroom will not be included in the monthly rent calculation. Reasonable accommodations are part of the cost of doing business, and no surcharges will be passed on to the occupants to pay for them. See Title II of the Americans with Disabilities Act for further information.

Appeal of Rent: If the primary occupant is unable to pay the amount of rent established by FEMA, they may appeal FEMA's rent determination within 60 days of receiving FEMA's notice of the requirement to pay monthly rent. Appeals must include documentation demonstrating the applicant does not have the financial ability to pay the established rent. Specifically, FEMA requires both of the following information:

- Pre-disaster versus post-disaster monthly gross income of all household occupants age 18 or older; and
- Pre-disaster versus post-disaster monthly housing costs, such as mortgage payments on the pre-disaster residence while it is being repaired.

FEMA may adjust the amount of rent using the following criteria:

- If the total monthly adjusted gross income amount of all occupants 18 years of age and older remained the same subsequent to the disaster, FEMA will consider the primary occupant capable of paying the same monthly amount for housing costs paid before the disaster or 30% of their household income, whichever is greater, but not to exceed the FMR.
- If the total monthly gross adjusted income amount of all occupants 18 years of age and older increased or decreased as a result of the disaster, FEMA will consider the primary occupant capable of paying a monthly amount for housing costs equal to 30% of their household income or the FMR, whichever is greater, but not to exceed the FMR.
- FEMA will subtract post-disaster monthly housing costs from the amount FEMA considers the primary occupant is capable of paying for housing costs to determine the FEMA adjusted rent amount to be charged, up to the applicable FMR. Housing costs may include rent and/or mortgage payments (including principal, interest, and real estate taxes) on the pre-disaster primary residence, real property insurance, and utility costs (not to include cable television, internet, and telephone service).
- FEMA will not charge any primary occupant more than the FMR for monthly rent.
- FEMA will not charge any primary occupant less than the FEMA minimum monthly rent amount of \$50.



Minimum Rent Amount

FEMA uses 30% of the total monthly adjusted gross income of all household members' income based on the formula used by HUD to determine the Total Tenant Payment (TTP). HUD allows a minimum rent amount to be set in the TTP formula of up to \$50. FEMA established \$50 as the minimum rent amount.

Rent for a THU will continue to accrue each month while FEMA is considering the appeal, which may take up to 90 days.

- If the appeal is denied, the primary occupant must pay the originally established rent in total within 30 days of the date of the appeal decision, including any rent not paid while FEMA was considering the appeal; or

- If the appeal is granted, the primary occupant must pay the adjusted rent in total within 30 days of the date of the appeal decision:
 - If the primary occupant paid the originally established rent amount while FEMA considered the appeal, FEMA will reimburse any overpayment based upon the amount of the adjusted rent.

6. Reasons for Terminating Direct Temporary Housing Assistance

The occupant's eligibility to live in a FEMA THU automatically expires at the end of the period of assistance, unless the period of assistance has been extended. FEMA may terminate an occupant's Direct Temporary Housing Assistance prior to the end of the period of assistance for the following reasons:¹²⁴

Program Eligibility Violations

- Occupants are not actively participating in the recertification process (e.g., not being available to meet with FEMA recertification staff on a regular basis).
- Occupants are not taking all actions necessary to achieve their PHP in a reasonable time frame.

Conduct Violations

In some cases, an occupant who committed a violation may be removed from the THU and other occupants may remain in the unit.

- **Major Violations:** Occupants engaging in conduct violations involving criminal activity in violation of federal, STT government law, or other actions which present an imminent threat to the health and safety of the occupant, other THU occupants, or persons in the surrounding area. Major violations must be supported by an arrest, police report or other documented health and safety concern and occur in the vicinity of the TTHU or be an immediate threat to one or more occupants of the TTHU or other persons in the surrounding area; however, FEMA does not have to wait for a conviction before terminating assistance. Examples of major violations include, but are not limited to:
 - Assault, battery, rape, domestic violence, child abuse, or sexual assault
 - The use, sale, possession, or manufacture of illegal drugs
 - Destruction or theft of property owned or leased by FEMA (including the THU), other THU occupants (including their guests), and contractors performing work for FEMA.

General Violations

Occupants engaging in conduct violations involving the breaking of rules established by the commercial park or other temporary housing site management rules included within the Temporary Housing Agreement or Revocable License. Examples of general violations include, but are not limited to:

- Excessive noise or disturbance of peace
- Unleashed or unattended pets outside of the THU
- Damage to the THU beyond normal wear and tear
- Failure to maintain reasonably clean and sanitary conditions both inside and outside the THU
- Failure to pay rent, after receiving a warning, and when rent has been assessed following the end of the period of assistance

Figure 24: FEMA Notification of Occupant Violations

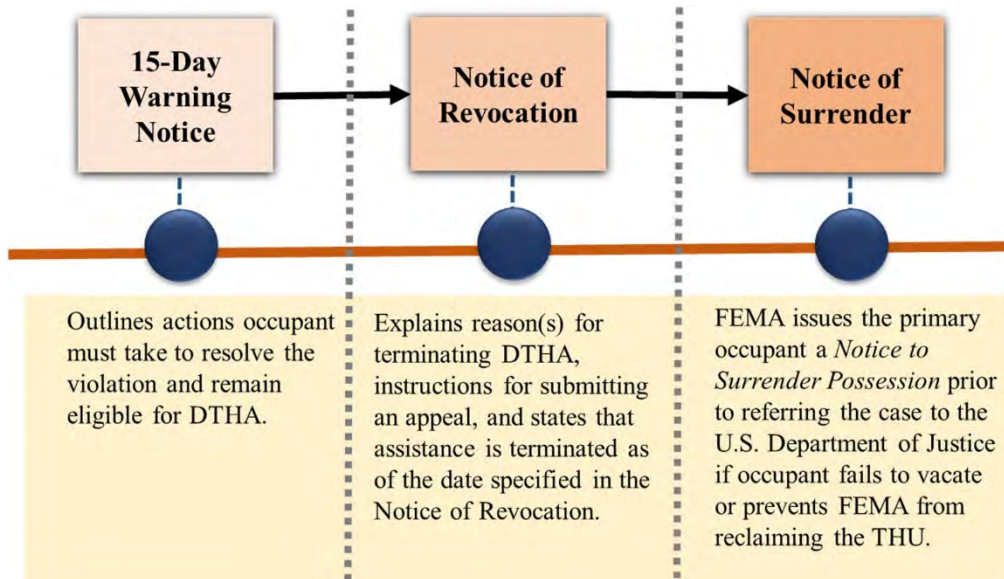

7. Process for Terminating Direct Temporary Housing Assistance

FEMA will follow the process outlined below to afford each occupant due process and ensure sufficient justification exists for termination.

- **Warning Notice:** After becoming aware of a program eligibility or general conduct violation, FEMA will notify the primary occupant through a 15-day warning notice, delivered in-person or through certified mail. This notice will outline the actions the occupant must take to resolve the violation and remain eligible for FEMA Direct Temporary Housing Assistance. FEMA will not issue a warning notice for Major Violations or the end of the period of assistance.

- **Notice of Revocation:** If the occupant fails to remedy the violation as outlined in the 15-day warning notice or commits a Major Violation, FEMA will issue the primary occupant a Notice of Revocation (NOR) explaining the reason(s) for terminating Direct Temporary Housing Assistance, instructions for submitting an appeal, and that assistance is terminated as of the date of the letter.
- **Notice to Surrender Possession:** If an occupant fails to vacate or prevents FEMA from reclaiming the THU, FEMA will issue the primary occupant a Notice to Surrender Possession prior to referring the case to U.S. Department of Justice.
- **Appeal Rights:** Occupants can appeal the termination decision within 60 days after receiving the NOR. However, filing an appeal does not relieve the occupant of the responsibility to vacate the THU by the deadline established in the NOR. Also, the occupant cannot appeal a NOR received due to the end of the period of assistance.

8. Penalty Fees

After the period of assistance has ended or an occupant is determined ineligible for continued assistance, primary occupants who fail to surrender the THU by the established deadline are subject to a monthly penalty fee for as long as any occupant remains in or maintains possession of the THU. FEMA may also charge the primary occupant a penalty fee when they fail to pay monthly rent when charged by FEMA or fail to relocate or assume financial responsibility for a TTHU purchased from FEMA as agreed to in the Acknowledgement of Conditions of Sale (see [Chapter 3, V.F.](#)).



Example of Penalty

If a homeowner fails to complete repairs or construction on their primary residence within the additional 90 days provided, FEMA will require the homeowner to pay the full, unreduced penalty fee for the length of time the homeowner or any occupant remains in or maintains possession of the THU.

Paying the penalty fee does not entitle an occupant to remain in a THU nor does it prevent FEMA from taking legal action to remove the occupant from the unit. A penalty fee is equivalent to the FMR plus a flat rate fee of \$550 or FMR plus FEMA’s actual monthly costs for the THU, whichever is higher. The flat rate of \$550 is based on the average actual monthly cost per unit for occupied TTHUs from years 2011 to 2015. *Figure 25* offers two examples of the penalty fee.

Figure 25: Example of a Penalty Fee				
Examples	FMR	Monthly Cost for THU	Flat Rate Fee	Penalty Fee
Example 1	\$1,000*	\$475	\$550*	\$1,550
Example 2	\$1,000*	\$1,350*	\$550	\$2,350

Asterisks indicate which columns are used to calculate each example penalty fee.

FEMA may consider reducing the penalty fee to the FMR if occupants meet all the following conditions:

- Primary occupants who are pre-disaster homeowners:
 - Have a PHP to repair or rebuild their primary residence;
 - Have not achieved their PHP through no fault of their own;
 - Need up to an additional 90 days beyond the end of the initial or extended period of assistance to complete the repairs or construction;
 - Have previously declined to purchase their TTHU after the Sales Program was implemented; and
 - Paid monthly rent to FEMA during an extended period of assistance, if applicable (see [Chapter 3, V.C.](#)); applicants who were charged rent by FEMA during an extended period of assistance but did not pay will not be considered for a reduced penalty fee.
- Primary occupants who are pre-disaster homeowners and renters:
 - Have a TTHU sale or donation pending beyond the initial or extended period of assistance through no fault of their own; and
 - Pay monthly rent to FEMA during an extended period of assistance, if applicable; applicants who were charged rent by FEMA during an extended period of assistance but did not pay will not be considered for a reduced penalty fee.

Primary occupants may appeal FEMA's decision to terminate assistance; however, the penalty fee may not be appealed. If FEMA accepts the appeal, overturns the termination, and reinstates Direct Temporary Housing Assistance, the occupant will not be required to pay a penalty fee. FEMA will refund the applicant any penalty fees the applicant paid during the appeal period.

Primary occupants who have not paid their penalty fee in full within 120 days of the date of receiving the bill will be referred to the U.S. Department of the Treasury for debt collection.



A FEMA staff member helps a disaster survivor apply for FEMA assistance

E. Multi-Family Lease and Repair

FEMA may provide Direct Temporary Housing

Assistance in the form of repairs or improvements to existing, vacant multi-family housing units (e.g., apartments).¹²⁵ FEMA may utilize units repaired or improved under MLR as temporary housing for eligible applicants who are unable to use Rental Assistance due to a lack of available resources. MLR is not intended to repair or improve individual units to re-house existing tenants.

1. Property Eligibility Requirements

Properties eligible for MLR must be located in a county/jurisdiction designated for Individual Assistance. In the event no properties are available or properties in the designated area have been exhausted, FEMA may utilize properties located in an undeclared county/jurisdiction in the same state or territory.

Properties located outside of the declared county/jurisdiction must be within reasonable commuting distance of the declared area and must have been impacted by a major disaster. Prior to utilizing a property in an undeclared county/jurisdiction, FEMA must determine that eligible applicants are unable to use financial rental assistance due to a lack of rental resources in the undeclared county/jurisdiction and that MLR properties would be a cost-effective option to other forms of direct temporary housing assistance in the undeclared county/jurisdiction.



Multi-Family Rental Housing

Multi-family rental housing is defined as a rental property that contains three or more dwelling units, each such unit providing complete and independent living facilities for one or more persons, including permanent provisions for living, sleeping, cooking, and sanitation.

In addition to the criteria described above and in Direct Temporary Housing Assistance Request and Approval (see [Chapter 3, V.A.](#)), FEMA must verify that one or more properties meet the following conditions of eligibility to authorize MLR:

- The property must have previously been used as multi-family rental housing;
- The property must be located in an area designated for IA under a major disaster declaration; or, if impacted by a major disaster, the property may be located in an undeclared county within reasonable commuting distance of an IA designated area;
- The property must be located within the same state or territory that received a major disaster declaration for the same incident;
- The property must be located within reasonable access to community and wrap-around services such as accessible public transportation, schools, fire and emergency services, grocery stores, etc.;
- The property must be available to be leased to FEMA allowing FEMA's exclusive use as temporary housing for eligible applicants for a term of no less than 18 months from the date of declaration;
- The property owner must agree to allow FEMA to make reasonable accommodation and/or modification repairs or improvements during the term of the lease agreement without requiring FEMA to remove the improvements at the end of the lease agreement; and

- The property owner must provide all property management services, including building maintenance, except where the property is leased or contracted from another government entity, in which case FEMA may directly provide such services.

In the event MLR properties are not available within areas designated for IA, FEMA may utilize properties impacted by the disaster in undeclared areas specifically, for the purpose of implementing MLR, providing:

- There are insufficient properties within already-designated areas to meet the housing need under MLR;
- The undeclared area is within the same state or territory as the area designated for IA;
- The properties in the undeclared areas were also impacted by the same incident;
- FEMA has identified suitable properties within areas proposed to be designated for MLR;
- The properties are necessary to provide temporary housing to eligible applicants within a reasonable commuting distance; and
- The Governor/Tribal Chief Executive or GAR/TAR submits a written request to add the areas to the major disaster declaration and the Associate Administrator for Response and Recovery approves the request.



Rental units in Louisiana being repaired under Multi-Family Lease and Repair to house eligible applicants.



Lease Agreement

Lease Agreement is defined as a lease or contract between FEMA and a property owner for use, and to allow for repairs or improvements to a multi-family rental property. It includes the terms and conditions associated with the use and repairs or improvements being made, and the authorized expenditures to be paid by FEMA to the property owner.

2. Approving Properties

Under the terms of any lease agreement for potential MLR property, the value of the improvements or repairs shall be deducted from the value of the lease agreement. Any repairs or improvements will not take more than four months to complete. To determine the cost-effectiveness of a potential MLR property, compared to other forms of Direct Temporary Housing Assistance, FEMA will take the following actions:

- Determine the estimated cost of repairs or improvements by performing an independent government cost estimate for the necessary repairs and improvements or receive an estimated cost for repairs and improvements from a building contractor.
- Determine the estimated cost of repairs or improvements to make at least one unit per lease agreement, per the Fair Housing Act or other applicable requirements, accessible to applicants with disabilities, including costs to provide marked and signed accessible parking, access to the unit, and accessible common areas.
- Determine the value of the lease agreement by multiplying the approved monthly Rental Assistance rate by the number of units, and then multiplying the number of months remaining between the date the repairs are completed and the end of the 18-month period of assistance.
- Deduct the estimated cost of repairs and improvements from the value of the lease agreement by using a two-tier approval process based on RV and MHU acquisition costs.



Fair Market Rent (FMR)

FMR is defined as housing market-wide estimates of rents that provide opportunities to rent standard quality housing throughout the geographic area in which rental housing units are in competition.

The fair market rent rates applied are those identified by HUD as being adequate for existing rental housing in a particular area. FEMA uses the applicable rate based upon the location of the housing unit, the number of bedrooms in the housing unit, and the fiscal year in which the major disaster declaration was issued.

Tier 1 Approval

- The RA or the FCO, if the RA has delegated the authority to the FCO, may approve MLR property repairs with a unit cost up to \$40,000, the average per unit acquisition cost of an Express MHU. An Express MHU is the smallest MHU in FEMA's inventory.

Tier 2 Approval

- MLR property repairs with a unit cost that exceeds the Tier 1 acquisition cost, will require the RA or the FCO, if the RA has delegated the authority to the FCO, to request approval from the IADD. The RA or FCO must provide a written request that includes:
 - Justification for why increasing MLR property costs above the per unit acquisition cost of an Express MHU is a more feasible, cost-effective, and survivor-centric solution; and
 - The requested increase MLR unit cost.

3. *Prioritizing Properties*

When multiple approved MLR properties exist, FEMA will evaluate properties according to the following factors:

- Cost to the Federal Government;
- Time to complete repairs;
- Landlord’s demonstrated ability to manage and/or provide maintenance services;
- Proximity to wrap-around services; and
- Accessibility.

When selecting available properties for use, FEMA will prioritize properties that:

- Make at least one unit accessible.
- Are in proximity to accessible public transportation.

FEMA will consider the specific needs of applicants with disabilities and others with access and functional needs. FEMA will prioritize accessible units for applicants whose household includes one or more persons with a disability. FEMA may only consider placing other eligible applicants in accessible units when all households with accessibility needs have been adequately housed.

4. *Property Repair or Improvement Service Contracting*

Once approved, FEMA has two options for repairing or improving an eligible MLR property. At its discretion, FEMA may either:

- Enter into a contract with the property owner for the property owner to perform necessary repairs and improvements to housing units to be provided for FEMA's exclusive use as temporary housing during the term of the lease agreement; or
- Enter into a contract with a third party to perform the repairs or improvements to the housing units and enter into a lease agreement with the property owner.

FEMA will only authorize repairs and improvements that:

- Make a property safe, habitable, accessible, and functional for temporary housing;
- Use materials of average quality, size, and capacity (“builder grade”), in accordance with Federal EHP laws, regulations, EOs, and local codes and ordinances, or minimum construction industry standards where no codes and ordinances apply;



Payment Scenarios for an MLR Property Owner

FEMA may, in some scenarios, make payments to an MLR property owner in addition to the costs for the repairs. FEMA may:

- Provide monthly rent to the property owner when the total estimated cost of repairs is less than the FMR value of the lease. The total amount of monthly rent payments may not exceed the difference between the total estimated cost of repairs and the FMR value of the lease. FEMA will not pay monthly rent when total projected cost of all necessary repairs and improvements equals or exceeds the FMR value of the lease.
- Provide a per-unit monthly maintenance fee for servicing repairs while FEMA utilizes the unit for temporary housing.
- Provide a per-unit security deposit payment to the landlord not to exceed one month of FMR based on the location and number of bedrooms.

- Promote living environments that are usable by the broadest spectrum of people, regardless of ability, without the need for adaptation or specialized design; and
- Are performed in compliance with local building codes, standards, permitting, inspection requirements, and all applicable EHP compliance requirements.

When repairs or improvements are made to provide accessibility features, contractors will be guided by the Americans with Disabilities Act Accessibility Guidelines (ADAAG)¹²⁶ and HUD's Design Details for Accessible Disaster Relief Housing.¹²⁷ FEMA will include the following accessibility features when repairs or improvements are required to these elements:

- Bathrooms:
 - Reinforcements to allow later installation of grab bars around toilet, tub, shower stall and shower seat, where such facilities are provided
 - Americans with Disabilities Act (ADA)-compliant toilets
- Faucets: Single-lever faucet controls
- Door knobs/handles: Lever-type handles
- Door locks: Single-push locks
- Drawers and Cabinets: D-loop or other easy-to-use handle pulls
- Flooring: Low-pile carpet or smooth anti-slip flooring

If FEMA identifies an MLR-eligible applicant with a disability whose housing needs cannot be met by an available unit, FEMA will make the necessary modifications as a reasonable accommodation and/or modification so the applicant receives a habitable, safe, accessible, and functional housing unit. FEMA will prioritize units that can be modified in the most time- and cost-efficient manner and best meet the requirements of the applicant. FEMA will incur all costs related to making the necessary repairs or improvements.

If construction costs begin to exceed the repair estimate at any time during the repairs, the project may need to be re-evaluated to ensure it still complies with the Stafford Act requirements. This will be a case-by-case determination based on the facts specific to the situation, based on the reason for the cost overruns, the extent to which they are directly in FEMA's control, and whether the increased costs cause the project to no longer be cost-effective.

5. Leasing Properties

The property owner must agree to incorporate a lease addendum containing MLR program conditions of eligibility and termination of tenancy between the property owner and the occupant. The property owner acknowledges responsibility for evicting applicants whose assistance is terminated. Property owners may receive reimbursement for reasonable costs associated with the eviction process if included in the contract.

FEMA may provide a per-unit security deposit payment to the landlord not to exceed one month of the FMR, based on location and number of bedrooms. Unused portions of each security deposit must be returned to FEMA upon release of the unit. If the security deposit amount does not cover the amount of damage to the unit, the occupant will be responsible to the property owner for the additional funds. FEMA will not pay for background checks, credit checks, application fees, or pet deposits.¹²⁸ FEMA will provide payment for utilities as part of the monthly rent only when utilities are included in the rent as an established practice by the property owner. Occupants are responsible for the payment of utility services when utilities are not included as part of the monthly rent.

The lease agreement between FEMA and the property owner must include the option to extend the lease if an extension beyond the standard 18-month period of assistance is approved. FEMA may release the unit to the owner and cease all monthly payments for the unit if the unit becomes vacant during the term of the contract and FEMA has not identified another eligible applicant to occupy the unit.

6. Limitations and Exclusions

Hotels, hospitals, nursing homes, etc. are not considered residential properties and are not authorized for MLR.

FEMA will not approve additional increases beyond the FMR approved by the AA for Recovery for the disaster.

F. Transportable Temporary Housing Units and Site Types

FEMA may provide Direct Temporary Housing Assistance in the form of TTHUs on sites with utility access that meet the needs of the household and comply with applicable SLTT government ordinances. Approved sites must also meet Federal floodplain management and EHP compliance requirements. FEMA selects locations based on the cost-effectiveness, timeliness, and suitability of each potential site. Sites may include private, commercial, and group sites.

1. Unit Types

TTHUs may be provided in the form of RVs or MHUs. FEMA determines whether an RV, MHU, or other form of temporary housing will be provided based on the applicant's household composition, the amount of time the applicant expects to require temporary housing, as well as the feasibility and cost of the available temporary housing options. FEMA prioritizes RVs for eligible applicants who are projected to have a temporary housing need of six months or less. For those with a projected need of longer than six months, FEMA will generally utilize another form of Direct Temporary Housing Assistance.

Recreational Vehicles

FEMA provides RVs that are certified to comply with the Recreation Vehicle Industry Association standards and meet California Air Resources Board (CARB) standards or are certified compliant with the Toxic Substances Control Act Title VI requirements for formaldehyde emissions from composite wood products found in RVs.

RVs may not be a suitable temporary housing solution for applicants with disabilities and others with access and functional needs. FEMA notifies applicants with a disability and others with access and functional needs who request an RV that a reasonable modification may be available upon request.

If a reasonable accommodation is requested but not available, FEMA works with applicants on a case-by-case basis to see if an acceptable alternative will effectively address the applicant's accessibility-related needs.

For eligible applicants who are unable to occupy an RV, FEMA will provide an MHU that complies with Uniform Federal Accessibility Standards (UFAS) or an available THU.

Manufactured Housing Units (MHUs)

FEMA provides MHUs constructed in accordance with HUD regulations.¹²⁹ FEMA MHUs are equipped with residential fire sprinklers, which can help save lives and prevent injuries. Residential fire sprinklers require a tank and pump system (TPS) to operate.

FEMA provides MHUs built to UFAS, including UFAS-compliant platform steps or ramps, and path of travel from the parking lot throughout the facility, to eligible applicants with a disability.

Utilities

Occupants are responsible for the payment of utility services regardless of the unit or site type when utilities are not included as part of the monthly rent or pad rent for the unit. FEMA may authorize payment for utilities that are included in the monthly rent as an established practice by the property owner prior to the disaster.

2. Site Types

Private Sites: Private sites are sites provided by an applicant at no cost to FEMA, typically on their property near their pre-disaster residence. FEMA inspects each potential private site to determine if the site is feasible for placing the size and type of unit that will meet the household's needs. FEMA may provide TTHUs on private sites under the following conditions:

- The owner of the private site must certify that they are the landowner and that FEMA has permission to access the site to deliver, install, maintain, repair, and remove the TTHU.
- The site has sufficient access to allow FEMA to safely deliver, install, and remove the TTHU and meets local zoning requirements for a TTHU.
- The site is sufficiently clear of debris and other obstacles for placement of a TTHU and accessories (including steps or UFAS-compliant steps or ramps) in accordance with local setback or lot boundary requirements and the household's needs.
- Sanitation, including public sewer or a private septic system, is available and functional at the site. FEMA will not perform any repairs to components of the site eligible for Home Repair Assistance (such as wells and septic tanks) in order to make the site feasible for a TTHU.



RV and MHU

Recreational Vehicle (RV): An RV is a vehicle designed as temporary living quarters for recreational, camping, travel, or seasonal use purchased or leased by FEMA and provided to eligible applicants for use as temporary housing for a limited period of time.

Manufactured Housing Unit (MHU): A manufactured home purchased or leased by FEMA and provided to eligible applicants for use as temporary housing for a limited period of time.

- Electrical service is available and functional and a temporary power pole and meter panel for providing electrical service to the TTHU can safely be installed by the local power company. FEMA will not connect electrical service for the TTHU to the applicant's pre-disaster residence.
- Potable water service is available and functional at the site.



MHU sits next to a residence in Zachary, Louisiana after flooding

Commercial Sites: FEMA may provide TTHUs on commercial sites when the rules of the commercial site do not violate the Fair Housing Act.

Commercial sites are existing manufactured home parks with available pads that FEMA may lease for the purpose of providing Direct Temporary Housing Assistance.

- FEMA will prioritize locations within reasonable commuting distance of and access to community and wrap-around services.
- FEMA, to the extent possible, leases commercial sites at a fair market price in the affected area based upon the pre-disaster pad lease rates.
- When FEMA provides a TTHU on the same site as an applicant's pre-disaster mobile home, the applicant is responsible for any existing pad rental costs.
- FEMA only authorizes reasonable and cost-effective repairs or improvements necessary to make the site functional (such as an electrical service upgrade), including those necessary to meet reasonable accommodation requests for qualified individuals with disabilities.
- FEMA will not pay additional costs for utilities, grounds maintenance, trash removal, snow removal, or any other costs unless such costs were typically included in leases and lease amount prior to the disaster and the utilities in question are not metered separately by the utility provider.
- FEMA will prioritize commercial sites with existing usable pads before considering sites which require improvement or expansion. FEMA will only consider expanding or improving existing commercial sites as a cost-effective alternative to building a group site. FEMA will deduct the total cost of expansion or improvements to commercial sites from the value of the lease agreement between FEMA and the park owner.



Manufactured housing units to be used as temporary housing for eligible applicants in a FEMA Staging Area in South Dakota.

Group Sites: Group sites are not automatically included as part of the Direct Temporary Housing Assistance approval. FEMA only considers group sites when the temporary housing need cannot be met by other direct temporary housing options. Group sites provided by the SLTT government may include publicly-owned park land with adequate available utilities. The RA will only approve group sites when the below conditions have been met:



Fair Housing Act

Title VIII of the Civil Rights Act of 1968 (Fair Housing Act) protects people from discrimination when they are renting, buying, or securing financing for any housing. The prohibitions specifically cover discrimination because of race, color, national origin, religion, sex, disability, and the presence of children.

- The FCO must certify the need for each group site in writing and provide a copy of the certification to the RA before initiating the final design. The FCO's certification of need for a group site must include:
 - A request from the SLTT government for the specific group site and an assurance that the SLTT government has exhausted all other housing options in the area;
 - An analysis demonstrating insufficient rental resources exist within a reasonable commuting distance of the proposed group site location to meet the needs of eligible applicants;
 - An assessment demonstrating an increase in the Rental Assistance rate (see [Chapter 3, IV.D.](#)) within the county or parish where the group site will be located will not be sufficient to meet the needs of eligible applicants;
 - Identification of any restrictions for placing TTHUs on private sites within the county or parish where the group site will be located, accompanied by:
 - Documentation of the FEMA JFO's efforts to negotiate waivers or otherwise seek relief from these restrictions to provide temporary housing for eligible applicants;
 - An analysis demonstrating that the group site would still be required if applicants whose private sites are infeasible solely because of the local restrictions were removed from consideration;
 - Identification of the efforts taken to identify commercial sites for placement of TTHUs; and
 - Identification of the efforts taken to identify MLR and Direct Lease properties within the county or parish where the group site will be located. This should include data to support the need versus the number of MLR and Direct Lease properties and units available.

The RA will provide justification for the approval of a group site, in writing, to the AA for Recovery.

Group sites will be implemented according to the following considerations:

- FEMA will partner with the affected SLTT government to identify and select group site locations. FEMA will prioritize sites provided by the SLTT government at no cost before leasing a site from a private party.
- FEMA only develops group site locations within reasonable access to community and wrap-around services (e.g., schools, fire and emergency services, grocery stores, etc.). FEMA, as a lead coordinator, engages external stakeholders who may be able to assist in implementing wrap-around services in and around group site areas. FEMA ensures all common-use areas of the group sites, including accessible paths of travel from the parking lot and throughout the site, are designed and built in accordance with UFAS. At least 15% of the pads in a group site and at least 5% of the TTHUs installed will comply with UFAS.
- FEMA will incorporate separate green spaces into group sites to accommodate households with children or pets.
- FEMA will make every attempt to design and build group sites in such a manner that playgrounds or other recreational equipment may be installed within or adjacent to the group site.
- FEMA must re-evaluate the need for group sites as the housing mission progresses (e.g., post-design and during all phases of construction). If at any time during the process applicants are able to be placed into other available direct housing options, the FEMA JFO will prioritize their placement into these other options instead of continuing to develop the group site.

3. *Wrap-around Services*

FEMA does not provide wrap-around services; however, FEMA will not provide Direct Temporary Housing Assistance in locations where disaster survivors will not have access to wrap-around services.

4. *Floodplain Management and EHP Considerations*

FEMA complies with EHP laws, regulations, and EOs when installing TTHUs. FEMA will not install TTHUs within areas which can result in loss of human life or will have adverse impacts on historic properties or endangered or threatened species or designated critical habitat. FEMA reviews each potential TTHU site for floodplain management concerns¹³⁰ and will not place TTHUs within a one percent annual chance floodplain unless no practical alternative exists.

When placing TTHUs on private and commercial sites, FEMA shall apply the abbreviated eight-step decision-making process for any proposed action that may occur in or may impact a floodplain or wetland.¹³¹ The decision-making process includes the following considerations:

- FEMA will identify if the potential TTHU site is located in an SFHA as identified on the available flood hazard information or a potential flooding area as identified on the Advisory Flood Hazard Information.
- FEMA will not place TTHUs within a floodway or coastal high hazard area (V zone), even under the eight-step process. FEMA will not place RVs in high flood risk areas with rapid rates of rise or flash flooding.
- When deciding whether a potential TTHU site in the floodplain is the only practicable alternative, FEMA considers the following factors: speedy provision of temporary housing; potential flood risk to the temporary housing occupants; cost-effectiveness; social and neighborhood patterns; timely availability of other housing resources; and potential harm to the floodplain or wetland.
- When FEMA determines that placing TTHUs within an SFHA is necessary for providing temporary housing for eligible applicants, FEMA will prioritize MHUs over RVs for sites within the floodplain. FEMA considers the availability of each type of unit, based on the number of MHUs available from FEMA's inventory, off the lot purchases, and additional production from manufacturers to determine when providing RVs within an SFHA may be necessary for providing expedient temporary housing in an SFHA.



Wrap-around Services

Wrap-around services address the support eligible applicants need while living in the TTHU. Wrap-around services may include basic social services, access to transportation, police/fire protection, emergency/health care services, communications, utilities, grocery stores, child care, and educational institutions.



Historic Property

The term "historic property" is defined in the National Historic Preservation Act as "any prehistoric or historic district, site, building, structure, or object included on, or eligible for inclusion on, the National Register, including artifacts, records, and material remains relating to the district, site, building, structure, or object" (54 U.S.C. § 300.308). An archaeological site may be considered a historic property under the law.

- Placement of TTHUs will be made in accordance with NFIP criteria or any more restrictive Federal, SLTT government floodplain management standard. Such standards may require anchoring and elevation to the base flood elevation in absence of a variance. FEMA will take into account seasonal variations in flood risk and flood depth when evaluating potential sites for TTHU placement.
- Units will be elevated to the highest level practicable and will be anchored to prevent movement. Actual elevation levels will be based on the manufacturers' specifications and agency guidance. RVs may be installed on their chassis but must also be adequately anchored. FEMA will coordinate with STT governments and local floodplain administrators to permit the installation of TTHUs.
- FEMA will provide applicants with information and advisories on the flood risk, including information relating to health and safety, evacuation, right of entry, and personal property, and contact information for the local emergency manager. FEMA will obtain acknowledgement from TTHU occupants that they have been provided this information.



Expedited EHP Compliance Review

Understanding the critical need for the placement of TTHUs following a disaster, FEMA has streamlining measures in place to ensure an EHP compliance review is completed in a timely manner. FEMA will complete the appropriate level of analysis depending upon the action. This could involve the simple application of a Categorical Exclusion (an action that has been documented to have little potential impact on the environment).

FEMA conducts appropriate EHP compliance analyses on potential group site locations and when expanding or improving commercial sites. Whenever possible, FEMA will avoid placement in locations where EHP compliance review has identified hazards or concerns related to environmental, historic, or cultural resources. EHP compliance reviews may require consultation with other Federal agencies and SLTT government resource agencies before work can begin.

FEMA may conduct additional EHP compliance review for private sites when they are found to have archeological resources, Federally-listed endangered or threatened species, designated critical habitat, or known hazardous substance contamination.

Consultations undertaken pursuant to the Endangered Species Act (ESA) will typically focus on ensuring ESA compliance by addressing a project's adverse effects to threatened and endangered species, as well as their designated critical habitat. However, consultations may result in the requirement to incorporate conservation measures for affected species and their designated critical habitat. FEMA will address environmental planning early in project scoping and project development stages to minimize delays and additional costs at the EHP compliance stage and to identify opportunities for implementing measures for the conservation of species.

G. Disposing of TTHUs through Sales to Occupants and Donations

FEMA is authorized to dispose¹³² of occupied TTHUs through sales to occupants or donations to qualified government agencies or voluntary organizations within the period of assistance.¹³³ Sales and donations are means to dispose of TTHUs, not forms of housing assistance. An occupant's participation in TTHUs sales or donations is voluntary. An occupant's decision not to participate does not affect their eligibility for Direct Temporary Housing Assistance during the period of assistance.

1. Authorizing Disposal through Sales and Donations

FEMA may dispose of occupied TTHUs by sale or donation in response to a written request from the STT government. The RA or FCO, if the RA has delegated the authority to the FCO, may implement TTHU sales and donations when:

- Rental resources are not expected to support those currently residing in FEMA-provided TTHUs within the period of assistance for the disaster declaration;
- Applicants' completion of repair or replacement of their disaster-damaged residences will not be possible within the period of assistance;
- Disposing of TTHUs is not expected to adversely affect local rental housing and manufactured housing markets;
- Disposing of TTHUs is expected to be in the best interest of the Federal government; and
- Disposing of TTHUs will not cause a significant impact on FEMA's ability to maintain necessary TTHU inventory.

Once approved, FEMA may sell occupied TTHUs to pre-disaster homeowners immediately following the implementation of Direct Temporary Housing Assistance. After determining that adequate, alternate housing has not returned to the housing market, and is not expected to return, the earliest FEMA will implement sales of occupied units to pre-disaster renters is six months following the date of declaration.

FEMA will not initiate or approve TTHU donations independent of TTHU sales to occupants. FEMA will only consider donation after all TTHU sales to occupants have been completed. Each TTHU Donation Agreement must be approved by the RA or FCO. For additional information, see [Chapter 3, V.G.](#)

2. TTHU Sales to Occupants

FEMA may dispose of occupied TTHUs by selling them directly to the occupant if that individual or household lacks permanent housing through no fault of their own.¹³⁴ FEMA will sell a unit at a price that is fair and equitable. When an applicant purchases a unit from FEMA, they must agree to assume responsibility for it. Upon selling the unit to the occupant, FEMA will notify the residence tax office.

Purchaser's Conditions of Eligibility: Only the primary occupant may request and complete the purchase of the TTHU.

The primary occupant must meet the following criteria to purchase the TTHU:

- Comply with all conditions and rules under Direct Temporary Housing Assistance (see [Chapter 3, V.D.](#)) and the Revocable License or Temporary Housing Agreement;
- Lack permanent housing and be unable to fulfill a PHP within the period of assistance through no fault of the occupant;
- Respond to the FEMA Sales Notice expressing interest in purchasing the unit;
- Demonstrate the household's financial ability (e.g., proof of income, insurance payout, personal savings, or external assistance from non-FEMA sources) to complete the purchase within the time frame required, typically 30 days after FEMA tenders the final sales offer; and
- Demonstrate they have obtained any or all permits or inspections required by the SLTT government for the sale and location of a TTHU.



One of several MHUs provided by FEMA in Crestwood, New Jersey following Hurricane Sandy.

A household that qualified for and received a TTHU through the citizenship or qualified alien status of a minor child member of the household may be eligible for a TTHU sale for the benefit of the child. FEMA staff will consult the Office of Chief Counsel to ensure the necessary legal requirements to complete the sale are met.

Determining the Price of the Unit:

MHU: FEMA will offer to sell the MHU to the primary occupant at the Adjusted Fair Market Value (AFMV), which is the Fair Market Value (FMV) minus a standard deduction of FEMA's average deactivation cost.

RV: FEMA will determine the FMV of the RV using the National Automobile Dealers Association (NADA) pricing guide and subtract FEMA's average deactivation cost to determine the AFMV.

FEMA may lower the sales price based upon the occupant's financial ability but will not reduce the sales price to less than 25% of the AFMV.¹³⁵ If the occupant feels they cannot afford to purchase the unit at the AFMV, the occupant may appeal FEMA's determination and petition for a reduced sales price.

- At the time FEMA calculates the reduced sales price, FEMA will consider the income and assets for all occupants over the age of 18 listed on the Temporary Housing Agreement.
- In order to purchase the TTHU at the reduced sales price, the primary occupant will be required to:
 - Apply toward the cost of purchasing the unit all Home Repair Assistance or Home Replacement Assistance for which the primary occupant cannot produce a receipt or other documentation showing it was used for its intended purpose;
 - Contribute 30% of the gross monthly income of all occupants 18 years of age or older toward the cost of purchasing the TTHU; and
 - Contribute 40% of the cumulative assets of all occupants 18 years of age or older toward the cost of purchasing the TTHU.
- FEMA’s decision on an occupant’s reduced sales price based on their appeal is a final Agency determination and not subject to further appeal.
- Individuals and households who are non-compliant with the NFIRA requirement to purchase and maintain flood insurance are not eligible for a reduced sales price.¹³⁶

Conditions of Sale: FEMA does not permit substitutions or exchanges of TTHUs. The primary occupant must agree to purchase the TTHU they currently occupy “as is” and “where is.” This includes all modifications and accessories in place at the time of sale, including those provided as accommodations for occupants with disabilities. All of the following exceptions apply to “as is” and “where is:”

- Where necessary, FEMA may perform minimum repairs needed to protect health and safety.
- When the TTHU being sold is located in a FEMA group site or a FEMA-leased commercial site, the primary occupant must:
 - Secure an alternate location that complies with all applicable Federal, SLTT government laws, codes, and ordinances;
 - Be able to move the unit within 30 days of sale; or
 - Assume the commercial site pad lease after the sale, if applicable.
- FEMA will not sell units for use in a floodplain or wetland unless the sale fully complies with the 8-step process.¹³⁷



Occupant Option at Commercial Sites

For commercial sites, the primary occupant may choose to assume the pad lease.

- MHUs in a floodplain must be elevated at least to the level of the 100-year flood prior to sale. FEMA will not pay to elevate an MHU above manufacturer specifications and agency guidance, which reflect the highest level practicable at installation.
- MHUs that are not elevated to the required height cannot be sold.
- FEMA will not sell RVs located within an SFHA.

The primary occupant acknowledges all terms of the sale on the Acknowledgment of Conditions of Sale document, including:

- Agreeing to maintain hazard and flood insurance on the unit, regardless of whether the TTHU is or will be located in an SFHA.
- Responsibility for all maintenance and utilities associated with the TTHU after completing the sale.
- RVs are not designated for use as a permanent dwelling but as temporary living quarters for recreational, camping, travel, or seasonal use.

FEMA will provide the primary occupant with an SF-97 Form, U.S. Government Certificate to Obtain Title to a Vehicle, signed by FEMA as the Transferor, upon collection of full payment and completion of the Acknowledgement of Condition of Sale. Payment must be made using a certified check or money order. After the sale is completed, the primary occupant and members of the occupant's household will no longer be eligible to receive FEMA Direct Temporary Housing Assistance for that disaster declaration.

3. TTHU Donations to Qualified Public Agencies and Private Organizations

FEMA may donate occupied TTHUs “as is” and “where is” to an SLTT government agency or a voluntary organization for the purpose of continuing to provide temporary housing to eligible occupants who cannot afford to purchase the TTHU at the lowest price FEMA will offer.¹³⁸ FEMA cannot donate directly to a TTHU occupant.¹³⁹

Eligible Recipient Entities or Organizations: FEMA must identify eligible recipient entities or organizations interested in receiving donated TTHUs. FEMA will give priority to SLTT government agencies for receiving TTHU donations before considering donating TTHUs to voluntary organizations. If government agencies are unavailable, FEMA will give priority to voluntary organizations that have been in existence for at least one year and have a history and demonstrated capability of assisting disaster survivors.

After identifying an eligible recipient entity or organization, FEMA must identify occupants who are eligible to participate.

Conditions of Eligibility for Occupants: Occupants may be considered for inclusion in TTHU donations when the following criteria are all met:

- The primary occupant satisfies all families coping with an emergency or a major conditions of eligibility under TTHU Sales to Occupants (see [Chapter 3, V.F.2.](#)) but does not have the financial ability to purchase a TTHU at the reduced sales price.

- The primary occupant lacks permanent housing and has not fulfilled a PHP through no fault of their own.
- The primary occupant continues to have a disaster-caused temporary housing need.
- The primary occupant indicates interest in participating in TTHU donations by replying to the Notice of Interest Letter with the required information.
 - If selected to participate in TTHU donations, the primary occupant must return the Acknowledgment Letter sent by FEMA, agreeing to be housed by the entity/organization approved to receive and manage the TTHU.

Conditions of Donation: FEMA will not donate any TTHU without a TTHU Donation Agreement signed by FEMA and the recipient entity/organization. The TTHU Donation Agreement will require the recipient entity/organization to:

- Use the occupied TTHU for the sole purpose of providing temporary housing to a FEMA-eligible occupant until the end of the period of assistance or for a minimum of one year, whichever is longer, unless:
 - The eligible occupant secures permanent housing earlier; and
 - FEMA is unable to identify another eligible applicant to occupy the unit for the remainder of this time period.
- Ensure the site where each TTHU is to be occupied complies with local codes, ordinances, 44 C.F.R. Part 9, and other EHP compliance procedures detailed in *FEMA Instruction 108-1-1*.
- Obtain and maintain hazard and flood insurance on the unit,¹⁴⁰ regardless whether the unit is or will be located within an SFHA.
- Not impose a rent or usage fee on an eligible occupant until after FEMA's initial period of assistance has ended.
- Acknowledge in writing, acceptance of any potential expenses (e.g., permit costs, insurance) related to the donation.
- Comply with the nondiscrimination provisions of the Stafford Act.¹⁴¹
- Notify occupants that RVs are not designated for use as a permanent dwelling but as temporary living quarters for recreational, camping, travel, or seasonal use.



Voluntary Organization

A voluntary organization is any chartered or otherwise duly recognized 501(c)(3) tax-exempt which has provided or may provide needed services, in cooperation and partnership with SLTT or other government agencies, to individuals and households.

Approval of Recipient Entities or Organizations: The RA or FCO must approve and sign all Donation of Temporary Housing Units Agreements when all the above criteria and documentation requirements have been met. Transfer of ownership is complete once the SF-97 Form, *U.S. Government Certificate to Obtain Title to a Vehicle*, is sent to the entity/organization. Upon approval, FEMA sends a Final Notification letter to participating occupants, stating that FEMA has approved the donation and giving the date of transfer of responsibility for providing temporary housing to the occupant.

4. Effect of TTHU Donations on FEMA Disaster Assistance

- During the period of assistance, an occupant's decision not to participate in a TTHU sale or donation does not affect their eligibility for continued Direct Temporary Housing Assistance.
- If an eligible occupant decides to participate in TTHU donation, upon the completion of the donation, the occupant will no longer be eligible to receive Direct Temporary Housing Assistance for that disaster declaration unless:
 - The recipient entity/organization fails to comply with the TTHU Donation Agreement;
 - The entity/organization's non-compliance creates an unmet disaster-caused temporary housing need for the eligible occupant during the period of assistance; and
 - The period of assistance remains open.

H. Direct Lease

Direct Lease is a form of Direct Temporary Housing Assistance where FEMA may lease existing residential properties for eligible applicants to use as temporary housing.¹⁴² FEMA will only authorize Direct Lease when the verified disaster-caused housing need cannot be met with other Direct Temporary Housing Assistance options.

1. Authorizing Direct Lease

In addition to the criteria described in [Chapter 3, V.A.](#), FEMA will consider Direct Lease when Direct Temporary Housing Assistance has already been approved and:

- Other forms of Temporary Housing Assistance (i.e., Rental Assistance, Multi-Family Lease and Repair, and TTHUs) have been evaluated and delivered in sequential order based on program criteria.
- Housing needs exceed FEMA's capacity to provide MLR units or TTHUs in a timely manner.
- FEMA has identified one or more properties that meet the criteria identified in Property Eligibility Criteria (see [Chapter 3, V.E.2.](#)).
- FEMA will not authorize Direct Lease:
 - For the sole purpose of providing temporary housing to applicants who are unable to pass a background and/or credit check; or
 - On the sole basis that Direct Lease is more cost-effective than providing TTHUs.
- The FCO must submit a written request to the AA for Recovery demonstrating Direct Lease is needed as a result of a Presidentially-declared disaster based on the criteria provided above. The AA for Recovery will review the request and make a final determination regarding approval of Direct Lease. Once Direct Lease has been approved, FEMA will contract with a property management company to locate, acquire, and manage properties for FEMA.

2. Approving Properties

FEMA must identify one or more properties, provided by the contracted property management company, that meet the following conditions of eligibility:

- The property must be an existing residential property, not typically available to the general public (i.e., corporate apartments, vacation rentals, and second homes), for use as temporary housing;
 - Units that may be obtained by applicants using Rental Assistance will not be acquired for Direct Lease;
 - Hotels, motels, and other transient accommodations will not be acquired for Direct Lease;
- The property must be currently available to rent for housing up to 200% of the HUD FMR, unless a greater amount has been approved by the AA for Recovery;
- The property must comply with Housing Quality Standards (HQS) established by HUD, and all utilities, appliances, and other furnishings must be functional;
- Each individual unit must provide complete living facilities, including provisions for cooking, eating, and sanitation within the unit;
- The property must be located in an area designated for IA included in a major disaster declaration; and
- The property must be located within reasonable access to community and wrap-around services, such as accessible public transportation, schools, fire and emergency services, grocery stores, etc.

The property owner must agree to include provisions within the lease agreement granting FEMA the following:

- Exclusive use of the housing units and sole discretion to identify and select occupants during the term of the lease agreement;
- The option to extend the lease if FEMA extends the period of assistance beyond 18 months;
- The option of releasing the unit to the owner and ceasing all monthly payments for the unit at any time by providing thirty days' notice;
- The ability to make permanent modifications or improvements to the property (at FEMA's expense) to provide a reasonable accommodation for an eligible applicant with a disability; and
- The property owner's agreement to modify any lease between the property owner and the occupant to incorporate FEMA's program conditions of eligibility and termination of tenancy. The property owner acknowledges responsibility for evicting applicants whose assistance is terminated. FEMA will factor reasonable eviction costs into the Direct Lease contract so that property owners may receive reimbursement for reasonable costs associated with the eviction process.

3. Prioritizing and Leasing Properties

Before leasing a property, FEMA will inspect the property to ensure compliance with HUD HQS, and verify the property owner's capacity to provide all property management services. This includes building maintenance, except where the property is leased or contracted from another government entity, in which case FEMA may directly obtain such services. Leasing actions, including any modifications or improvements, are subject to EHP and floodplain management compliance requirements. When more eligible Direct Lease properties have been identified than are required for temporary housing, FEMA will use the following factors to prioritize:

- Cost to the Federal Government:
 - The RA or FCO, if the RA has delegated this authority to the FCO, is authorized to approve properties up to 200% of the FMR, if:
 - Lower cost units are unavailable or already used; and
 - A housing market analysis supports the approved increase.
 - The AA for Recovery must approve Direct Lease costs above 200% of FMR.
- Landlord's demonstrated ability to manage and provide maintenance services;
- Proximity to wrap-around services; and
- Accessibility: when selecting available properties, FEMA will prioritize properties that are already accessible, include accessibility features, or can be easily made accessible; and/or are in proximity to accessible public transportation.

FEMA will prioritize accessible units for applicants whose household includes one or more persons with a disability and others with access and functional needs. FEMA may only consider placing other eligible applicants in accessible units when all households with accessibility needs have been housed. FEMA may authorize a one-time payment of security deposits for each unit based on FMR. Unused portions of each security deposit must be returned to FEMA upon release of the unit. If the security deposit amount does not cover the amount of damage to the unit, the occupant will be responsible to the property owner for the additional funds. FEMA may authorize payment for utilities that are included in the monthly rent as an established practice by the property owner prior to the disaster; however, FEMA will not pay for background checks, credit checks, pet deposits,¹⁴³ or application fees. Occupants are responsible for the payment of utility services when utilities are not included as part of the monthly rent.

I. Permanent Housing Construction

FEMA may provide financial assistance or direct assistance to individuals and households to construct permanent or semi-permanent housing in insular areas outside the continental U.S. FEMA may also consider providing such assistance in other locations where no alternative housing resources are available, and other types of Temporary Housing Assistance are unavailable, infeasible or not cost-effective.¹⁴⁴ PHC may be provided in the form of direct assistance such as repairs or new home construction.

Repairs and new construction provided under PHC are limited to real property components eligible under FEMA Housing Assistance such as HVAC, walls, floors, ceilings, etc. Under PHC, FEMA will not repair or replace items eligible under Personal Property Assistance, such as furnishings and appliances.



Unavailable, Infeasible, and Not Cost-Effective

Unavailable: Temporary housing options do not exist for any reasonable cost or in any reasonable time. Rental housing is not available and other forms of temporary housing cannot be constructed and deployed in sufficient numbers.

Infeasible: Rental Assistance cannot be used because there are no available rental resources, or other forms of Direct Temporary Housing Assistance cannot be utilized because of terrain, distance, physical barriers, or time delays, that with reasonable means, FEMA cannot overcome.

Not Cost-Effective: The cost of providing another form of direct temporary housing option (MLR, TTHUs, and Direct Lease) is higher than providing PHC.

1. PHC Request and Approval

FEMA will only authorize PHC in response to a written request from the State, Territorial, or Tribal Coordinating Officer or the Governor/GAR or the Tribal Chief Executive/TAR. In order to recommend the use of PHC, the Sheltering and Housing Strategy must demonstrate that Temporary Housing options are unavailable, infeasible, or not cost-effective, including MLR, MHUs, RVs, and Direct Lease.

- The request must also identify all Federal, SLTT government compliance requirements, including:
 - The status and requirements of the currently-adopted building code, zoning, permitting process and requirements, and any impediments and requirements that may impact the delivery of PHC;
 - Cultural and climate considerations; and
 - Standard types of housing used in the area.
- Identify useful studies, projects, and reports, including Mitigation Assessment Reports, if available, that address the performance of buildings and essential facilities in the declared STT government, with specific recommendations for improving performance.

- The PHC request must include the following:
 - PHC Repair:
 - Analysis of the estimated associated costs, based on real property line items;
 - Availability of sources of repair labor other than FEMA, such as contractors or voluntary agencies; and
 - A disaster-specific financial cost cap recommendation for each type of PHC approved. The cost cap amount will be set through data collected through the Sheltering and Housing Strategy based on the square footage and pre-disaster market value of an average home in the declared area.
 - PHC New Construction:
 - Identification of potential new construction options appropriate for the culture, climate, and environmental requirements within the affected areas;
 - A comparative analysis of the timeliness, cost, feasibility, and suitability of each new construction option; and
 - A review of hazard mitigation measures (e.g., incorporation of seismic resistance in design and construction) and construction methods to be applied to ensure new construction provided by FEMA is resilient towards future hazards.
- Within PHC, FEMA will prioritize the use of PHC to repair existing homes before constructing new homes.
 - Before authorizing PHC, FEMA will develop a Business Case, to include:
 - Contract requirements, procurement strategy, project management plan, resource sourcing methods, and a comparative analysis of the available construction options, including the cost, speed, and feasibility of each.
- FEMA may also include the shipment of construction materials in the PHC authorization.
- The AA for Recovery will evaluate the PHC request using information obtained through the Direct Housing Assessment in order to approve PHC. If the request clearly demonstrates a need for PHC, the AA for Recovery will specify relevant conditions for implementation, such as establishing a disaster-specific financial cap for PHC Repairs.

Upon receipt of the authorization to implement PHC, FEMA will require the affected STT government to execute an amendment to the FEMA-State/Territory/Tribe Agreement.

Figure 26: Conditions for PHC Repair or New Construction

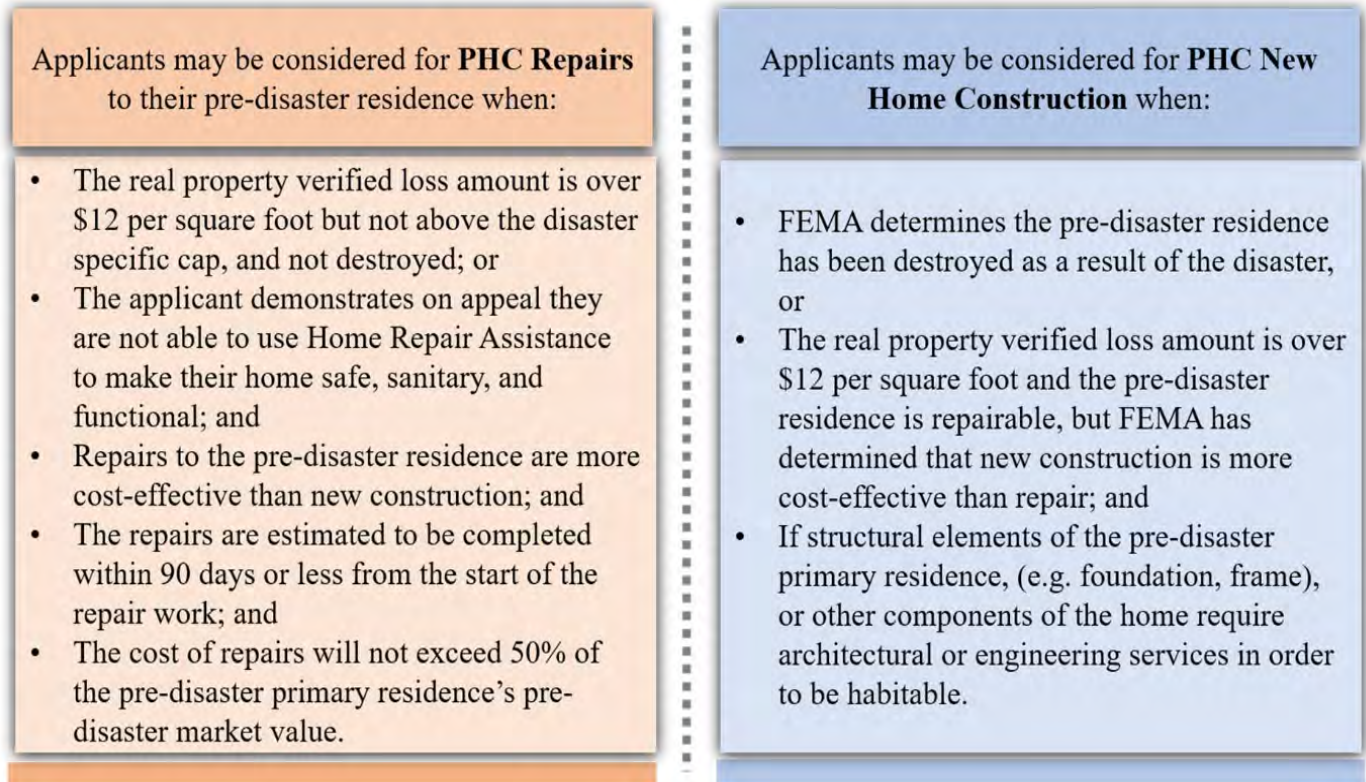

2. Conditions of Eligibility

FEMA may authorize PHC for pre-disaster homeowners. Similar to other forms of Direct Housing Assistance, FEMA prioritizes applicants with a real property verified loss of at least \$12 per square foot. Applicants who have less than \$12 per square foot in FEMA-verified losses may submit an appeal (see [Chapter 3, II.C](#)) with documentation that demonstrates they are not able to use FEMA financial assistance to secure temporary housing or afford repairs to make their home safe, sanitary, and functional. In addition to meeting general conditions of eligibility (see [Chapter 3, II.](#)), applicants must meet the following conditions in order to receive PHC:

- Applicants are unable to use Temporary Housing Assistance.
- Applicants are not receiving Continued Temporary Housing Assistance or Direct Temporary Housing Assistance.
 - Applicants will become ineligible for PHC if they receive Continued Temporary Housing Assistance or Direct Temporary Housing Assistance.
- Applicants do not have insurance for repair or replacement.
- Applicants must disclose to FEMA all grants and assistance received, including SBA disaster home loans for real property damages, and return any funds determined to be a DOB to FEMA prior to construction including previously awarded Home Repair Assistance or Home Replacement Assistance.

- Applicants have not accepted a disaster home loan from the SBA.
 - Applicants who have accepted an SBA disaster home loan for real property damages may be eligible for PHC if they cancel their SBA disaster home loan prior to disbursement.
 - Applicants who have accepted and received disbursement of an SBA disaster home loan for real property damages are not able to return those funds or cancel the loan in order to be considered for PHC.

3. PHC Repair

FEMA will only perform repairs necessary to restore the pre-disaster residence to a habitable condition. The components that may be deemed eligible for Home Repair Assistance, and the type of repairs authorized, will vary depending upon the nature of the disaster.

In order for the household to be eligible for PHC Repair, FEMA must determine that the repairs necessary to make the home safe, sanitary, and functional can be completed within 90 days and under the disaster-specific approved cost maximum.

The following components may be repaired or replaced:¹⁴⁵

- The structure's interior, including walls, ceilings, doors, and cabinetry;
- Interior floors, when buckling or deterioration creates a safety hazard;
- Interior walls, limited to what is necessary to maintain the structural integrity of the home;
- Exterior walls, doors, and windows, limited to what is necessary to maintain the structural integrity of the home and meet local codes;
- Roof, when the damage affects the essential living area or are necessary to prevent additional damage;
- Plumbing system, including fixtures providing service to the kitchen and bathroom(s), and flushing and/or purifying the water well;
- Electrical system and essential fixtures necessary to ensure the home can safely receive electrical service;
- Sewerage system;
- HVAC, and integral fuel and electrical systems; and
- Pre-existing accessibility features and accessible routes.

All repairs shall be made using materials of average quality, size, and capacity ("builder grade"), in accordance with Federal EHP laws, regulations, EOs, and local codes and ordinances, or minimum construction industry standards where no codes and ordinances apply. Repairs to accessibility features and accessible routes will be guided by the ADAAG and the HUD's Design Details for Accessible Disaster Relief Housing.

4. PHC New Construction

FEMA will only complete PHC New Construction when an applicant's pre-disaster primary residence is determined to be destroyed or determined to be infeasible for PHC Repair because the home requires repairs which exceed the scope of PHC Repair Assistance. New construction shall be provided in accordance with EHP laws, regulations, EOs, and local codes and ordinances, or minimum construction industry standards where no codes and ordinances apply, using materials of average quality for the lowest price ("builder grade"), taking into consideration the accessibility needs of the occupant.

- FEMA partners with the affected SLTT government to select the type of construction and architectural design that meet SLTT government construction restrictions and EHP compliance regulations based on cultural and climate considerations, and standard type of housing used in the area. In addition, FEMA EHP staff will work with other Federal agencies and SLTT governments to determine if there are opportunities to incorporate conservation measures that would benefit Federally-listed threatened and endangered species and their designated critical habitat in the project area.
- New construction for households requiring accessibility features and accessible routes will be provided in accordance with UFAS.
- New construction shall be provided using mitigation practices to reduce the risk of damage from future disasters.
- FEMA and the affected SLTT government shall coordinate to ensure any PHC new construction complies with floodplain management regulations. New construction in an SFHA must comply with the full eight-step process and be installed in compliance with all applicable National Flood Insurance Program (NFIP) standards and local floodplain management codes, ordinances, and standards.
- The land/property where the new single-family dwelling will be constructed must be owned by the eligible applicant. In limited circumstances, FEMA will evaluate providing PHC on land provided by the SLTT government at no cost to FEMA (e.g., insular areas, islands, or tribal lands where land ownership may vary; for instance, communal land or land held in trust by the STT government).

Labor and materials costs for PHC New Construction will be capped at a pre-determined amount for each declared disaster. The FEMA JFO may submit a request to increase the authorized labor and materials costs for PHC New Construction, supported by a business case demonstrating the requested increase is necessary to construct adequate housing and the additional expenses are fair and reasonable.

5. PHC Terms and Conditions

Prior to FEMA providing PHC, applicants must:

- Acknowledge they understand and accept FEMA's terms and conditions for PHC assistance.
- Agree to obtain and maintain flood insurance coverage on the PHC home for at least the value of the PHC residence if the home is located in an SFHA and the applicant incurred damage to their pre-disaster residence as a result of a flood.¹⁴⁶ FEMA will not contribute to the cost of flood insurance premiums for PHC residences. If the applicant fails to maintain flood insurance, they may be deemed ineligible for flood-insurable losses in future disasters.
- Choose between receiving FEMA financial Housing Assistance (LER, Rental Assistance, Home Repair Assistance, and Home Replacement Assistance) or PHC.
- Return any previously-provided financial Home Repair Assistance and Home Replacement Assistance that has not been used for eligible repair or replacement line items to FEMA.
- Grant right of access and entry upon their property to FEMA and other participating U.S. Government agencies, including their agents, employees, contractors, and subcontractors for all activities necessary for providing PHC.
- Accept all responsibility and liability for the PHC dwelling upon completion including but not limited to recording fees and other costs associated with obtaining the title.
- Indemnify and hold harmless FEMA and other participating U.S. Government agencies, including their agents, employees, contractors, and subcontractors, from any complaints, losses, and damage of sorts, directly or indirectly related to any program-related activity on the real property site.

VI. Other Needs Assistanceⁱ

The ONA provision of the IHP, authorized by Section 408(e) of the Stafford Act,¹⁴⁷ provides financial assistance for disaster-related necessary expenses and serious needs that are not covered by insurance or provided by any other source. Unlike Housing Assistance, ONA is subject to a cost share between FEMA and the STT government.¹⁴⁸ FEMA, in coordination with the STT government pre-determines ONA-eligible items and amounts to be awarded.



Necessary Expense and Serious Needs

A “necessary expense” means the cost associated with acquiring an item, obtaining a service, or paying for any other activity that meets a serious need.

A “serious need” means the requirement for an item or service that is essential to an applicant’s ability to prevent, mitigate, or overcome a disaster-caused hardship, injury, or adverse condition.

A. ONA Options and Cost Shares

FEMA collaborates with the SBA in determining applicant eligibility for some types of ONA. The Small Business Act authorizes the SBA to provide low-interest disaster loans to applicants who have sustained damage in a disaster. An applicant must meet a minimum income test, which the SBA establishes, to be considered for a loan. FEMA refers the applicant’s information to SBA if the applicant’s income meets SBA minimum guidelines. FEMA and SBA coordinate to ensure that ONA and SBA disaster loans do not cause a duplication of benefits for the same type of assistance.¹⁴⁹

Figure 27: SBA Disaster Loan Application Process

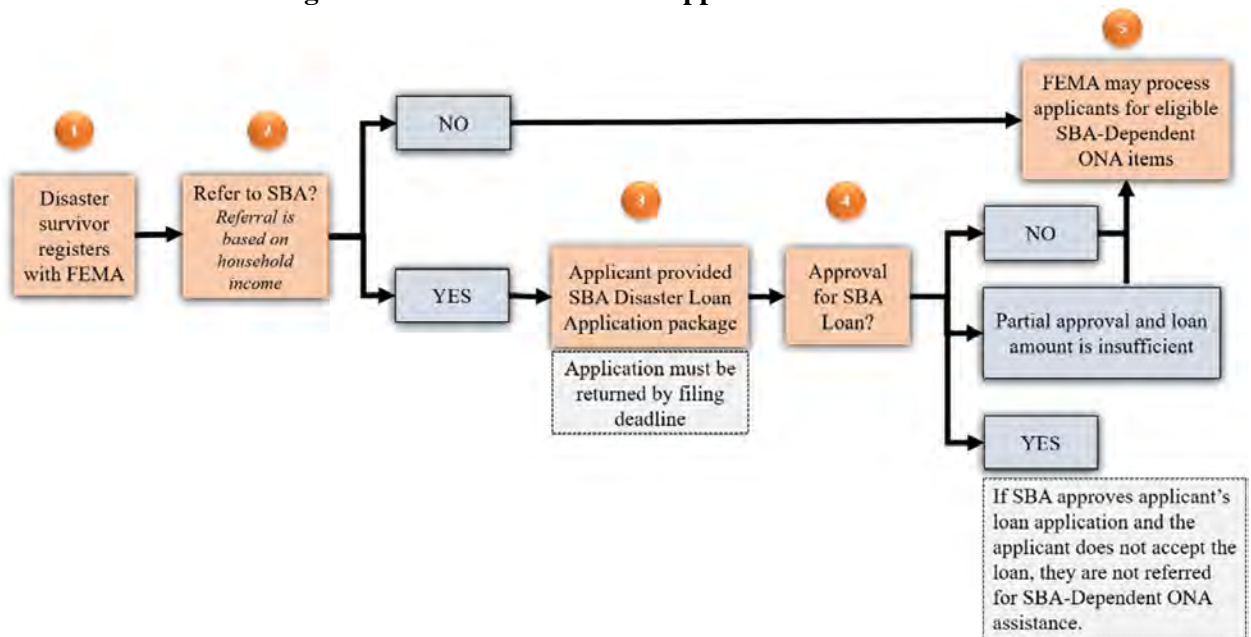

*The SBA Disaster Loan application process only applies to SBA-Dependent ONA. FEMA does not require the applicant to apply for an SBA loan before being considered for Non-SBA-Dependent ONA or Housing Assistance.

ⁱ OMB revised the regulations that govern federal grants and cooperative agreements, please refer to Title 2 of the Code of Federal Regulations for more details. See [Electronic Code of Federal Regulations](#).

Each type of ONA has specific conditions of eligibility applicants must satisfy prior to being considered for assistance. These conditions are described in the appropriate sections of this chapter.

Figure 28: Other Needs Assistance, Non-SBA-Dependent and SBA-Dependent	
Category of ONA	Type of ONA Assistance
<p>Non-SBA Dependent ONA</p> <p>FEMA provides assistance for these items without regard to whether an applicant may obtain an SBA loan.</p>	<ul style="list-style-type: none"> • Funeral Assistance • Medical and Dental Assistance • Child Care Assistance • Assistance for Miscellaneous Items • Moving and Storage Assistance • Critical Needs Assistance • Clean and Removal Assistance
<p>SBA-Dependent ONA</p> <p>The applicant must first apply to the SBA for a loan for these expenses or serious needs.</p>	<ul style="list-style-type: none"> • Personal Property Assistance • Transportation Assistance • Group Flood Insurance Policy

1. Amount of Assistance

Assistance for an eligible applicant will not exceed the financial ONA maximum award pursuant to Section 408(h) of the Stafford Act.¹⁵⁰ However, Personal Property Assistance for specific disaster-damaged accessibility items is not limited by a financial maximum award. The following accessibility items are eligible under Personal Property Assistance:

- Computer, if used as the sole means of communication for a household member
- Raised toilet seat
- Washer (front-loading), if a member of the household uses a wheelchair or has a similar mobility limitation
- Refrigerator (side-by-side), if a member of the household uses a wheelchair or has a similar mobility limitation
- Bed (hospital type)
- Walker
- Wheelchair
- Shower Chair
- Smoke Alarm (specialty), if a member of the household is sight or hearing-impaired
- TTY/ TDY Telephone

For some specific categories of ONA, the affected STT government will establish the maximum amount of financial assistance that may be awarded as part of their yearly submission of *FEMA Form FF-104-FY-21-114, ONA Administrative Option Selection*.¹⁵¹

Figure 29: Excerpt of FEMA Form FF-104-FY-21-114: ONA Administrative Option Selection

STATE/INDIAN TRIBAL GOVERNMENT SELECTION AND LINE ITEM MAXIMUM	
The State/Indian Tribal Government of _____ selects the following administrative option for the administration of the Other Needs Assistance provision of the Individuals and Households Program:	
<input type="checkbox"/> FEMA Option: FEMA Administers & Processes. <input type="checkbox"/> JOINT Option: State/Indian Tribal Government Administers & FEMA Participates: <input type="checkbox"/> FEMA Processing System Auto-determination ON <input type="checkbox"/> FEMA Processing System Auto-determination OFF <input type="checkbox"/> STATE/INDIAN TRIBAL GOVERNMENT Option: State/Indian Tribal Government Administers & Processes.	
The State/Indian Tribal Government approves the following line item amounts to be awarded for ONA:	
Transportation Repair:	\$ _____
Transportation Replace (Total loss)	\$ _____
Funeral Maximum (Unmet Need):	\$ _____
Child Care Assistance (Maximum)	\$ _____
<input type="checkbox"/> The State/Indian Tribal Government approves the additional ONA Personal Property and/or Miscellaneous items. Attached is the list of additional items, the justification, and situations for use.	
This administrative option is agreed upon by:	
STATE/INDIAN TRIBAL GOVERNMENT AUTHORIZING SIGNATURE	FEMA AUTHORIZING SIGNATURE
_____ Governor/Tribal Chief Executive or Designee Date _____	_____ Regional Administrator or Designee Date _____

FEMA Form FF-104-FY-21-114 (formerly 010-0-11)
(3/21)

Page 1 of 3

2. ONA Cost Share and Administration

As outlined in Section 408(g)(2) of the Stafford Act, FEMA is responsible for 75% of ONA, and the STT government is responsible for the remaining 25% of ONA.

The STT government may select from the following three options for the administration of the ONA (see *Figure 30*):

- FEMA Option:** FEMA is responsible for all tasks associated with the administration of ONA: registration intake, inspection services, the processing system, disbursing awards, staffing, recovery of funds, case processing, mail processing, accessible forms of communication, appeals, and preparing closeout material. FEMA utilizes the National Emergency Management Information System (NEMIS) for processing all IHP assistance, including ONA. FEMA provides assistance to applicants, and the STT government is responsible for reimbursing FEMA for their portion of the cost share.¹⁵²



Federal Share

Section 408(g)(2) of the Stafford Act explicitly provides that the Federal share shall be 75%, giving FEMA no authority to adjust the Federal cost share for ONA. However, 48 U.S.C. § 1469(a) allows FEMA to waive or adjust the cost share for disaster grants in insular areas such as the Virgin Islands, Guam, American Samoa, and the Northern Mariana Islands.

- Joint Option:** The STT government administers ONA jointly with FEMA. FEMA is responsible for registration intake, inspection services, the processing system, mail processing, and accessible forms of communication. The STT government is responsible for manually processing awards, staffing, recovery of funds, case processing, appeals, and preparing closeout material. The respective STT government uses NEMIS for ONA processing, but may utilize their own system of record for other program administration functions, such as disbursing awards.¹⁵³ The STT government provides assistance to applicants, and FEMA is responsible for reimbursing the STT government, for its portion of the cost share. The STT government may utilize 5% of the grant toward administrative costs.
- State, Territorial, or Tribal Government Option:** FEMA provides ONA as a grant to the STT government; therefore, the STT government administers ONA. The STT government is responsible for all tasks associated with the administration of ONA. The respective STT government receives a grant to process ONA outside of NEMIS. The STT government provides assistance to applicants, and FEMA is responsible for reimbursing the STT government for its portion of the cost share. The STT government may utilize 5% of the grant toward administrative costs.¹⁵⁴

Figure 30: ONA Administrative Option Responsibility

Process	FEMA Option	Joint Option	State, Tribal, Territorial Option
Registration Intake	FEMA	FEMA	State*
Inspection Services	FEMA	FEMA	State
Processing System	FEMA	FEMA	State
Disbursing Awards	FEMA	State	State
Staffing and Helpline	FEMA	State	State
Recovery of Funds	FEMA	State	State
Case Processing	FEMA	State	State
Mail Processing	FEMA	FEMA	State
Appeal Processing	FEMA	State	State
Preparing Closeout	FEMA	State	State

Note: The references to “State” include applicable tribal governments and territories.

3. ONA Administrative Option Selection Form

Regardless of the administrative option selected, all STT governments must indicate their option selection every year using the ONA Administrative Option Selection Form, which must be completed and provided to FEMA by November 30 of each year.¹⁵⁵

The STT government also uses the ONA Administrative Option Selection Form to identify limits for specific ONA items and establish maximum award amounts for Transportation Assistance, Funeral Assistance, and Child Care Assistance. Additional line items, other than those on FEMA's *Standard Personal Property Line Items* list, may be requested when submitting or updating the ONA Administrative Option Selection Form.



ONA Administrative Option

The ONA Administrative Option Selection Form must be completed and submitted to the FEMA RA by November 30th each year. FEMA must have a current, approved SAP on file before any assistance can be provided.

The *Standard Personal Property Line Items* list identifies all ONA-eligible personal property and miscellaneous items, as well as the maximum number of items each individual or household may receive. The STT may obtain a copy of the most current *Standard Personal Property Line Items* list from their respective FEMA Region.

The STT government submits the applicable forms to the RA, who reviews and approves the documentation.¹⁵⁶ FEMA Headquarters also reviews the documentation to ensure consistency across disasters and for implementation.

STT governments, which select the Joint or the State, Territorial, or Tribal Government Option, must also submit a State Administrative Plan (SAP) every three years.¹⁵⁷ The SAP describes the procedures the STT government will use to administer ONA.¹⁵⁸ The RA must review and approve the SAP prior to submitting the documentation to FEMA Headquarters for coordination of implementation.¹⁵⁹



State Administrative Plan

References to "State Administration Plan" in this document also include "Tribal Administration Plan" and "Territorial Administration Plan," as appropriate. The requirements found in 44 C.F.R. § 206.120(c) for State Administrative Plans also apply to tribal governments and territories.

The ONA Administrative Option Selection Form and the SAP may be changed during any non-disaster time period or within three days of a major disaster declaration.¹⁶⁰ However, in order for an STT government to change to the Joint Option or State/Territory/Tribe Option, they must submit an SAP.

B. Non-Small Business Administration-Dependent

The types of assistance described in this section are non-SBA-dependent, meaning FEMA does not require the applicant to apply for an SBA loan before being considered for these types of ONA. FEMA may award applicants Funeral Assistance and Child Care Assistance up to the limits established by the STT government in the ONA Administrative Option Selection Form, rather than paying fixed amounts based on FEMA inspection verification.

1. Funeral Assistance

FEMA provides financial assistance under the ONA provision of the IHP to individuals and households with disaster-caused funeral expenses.¹⁶¹ Unlike most other forms of IHP assistance, an applicant seeking Funeral Assistance does not need to live in the Presidentially-declared disaster area to be considered for the assistance. An individual who incurs or will incur expenses related to a death or disinterment attributed directly or indirectly to a declared emergency or major disaster may apply for and, if eligible, receive Funeral Assistance. Multiple registrations for the same deceased are not allowed. The affected STT government establishes the maximum amount of Funeral Assistance that may be awarded per death or per household as part of the ONA Administrative Option Selection Form.



Funeral Assistance Key Terms

Interment: The placement of cremated remains or deceased human bodies in the ground, a cremation urn, or other burial facility such as a columbarium. A columbarium is a place where urns holding a deceased's cremated remains are stored and memorialized.

Disinterment: The unearthing of cremated remains or deceased human bodies from the ground, a cremation urn, or other burial facility such as a columbarium.

Reinterment: The replacement of cremated remains or deceased human bodies in the ground, a cremation urn, or other burial facility such as a columbarium.

Funeral Services: Services to care for and prepare deceased human bodies and services to arrange, supervise, or conduct the funeral ceremony. Services may include preparation of the deceased (e.g., embalming, cremation); use of facilities; staff for viewing; funeral ceremony or memorial service; use of equipment; staff for graveside service or committal service; use of hearse/funeral coach; etc.

Conditions of Eligibility

In addition to meeting general conditions of eligibility (see Chapter 3, II.), applicants must meet the following conditions in order to receive Funeral Assistance:

- A medical examiner, coroner, or other certifier has attributed the death to the emergency or disaster, either directly or indirectly.
 - The medical examiner, coroner, or other certifier may reference the guidance set forth by the Centers for Disease Control and Prevention (CDC) regarding death certifications in the event of natural, human-induced, or chemical/radiological disasters.¹⁶²
 - Documentation stating the death "may have been caused by" or "was likely a result of" the emergency or disaster is not considered sufficient attribution

- The applicant incurred or will incur eligible funeral expenses not covered by other sources. Other sources may include burial insurance or financial assistance from voluntary agencies, applicable government programs/agencies, or other entities.
 - The following items are eligible expenses for interment or reinterment:
 - Transfer of remains;
 - Casket or urn;
 - Burial plot or cremation niche;
 - Marker or headstone; and/or
 - Additional expenses mandated by any applicable SLTT government laws or ordinances.
 - The following items are eligible expenses only for interment:
 - Transportation for up to two individuals to identify the deceased, if such identification is required by SLTT government authorities;
 - Interment;
 - Funeral services;
 - Clergy or officiant services; and/or
 - Costs associated with producing and certifying up to five death certificates.
 - The following items are eligible expenses only for reinterment:
 - Cost of identifying disinterred human remains
 - Reinterment (including costs for preparing and transporting the remains);
 - Funeral services (limited to the preparation and use of facilities to prepare the remains for reinterment)

Required Documentation

An applicant must submit:

- An official death certificate that clearly indicates the death was attributed to the emergency or disaster, or a signed statement from a medical examiner, coroner, or other certifier, attributing the death to the emergency or disaster, either directly or indirectly.
 - A death is directly attributed to a disaster if caused by the forces of the disaster or the direct consequences of the forces, including but not limited to structural collapse, flying debris, or radiation exposure.
 - A death is indirectly attributed to a disaster if it occurs as a result of unsafe or unhealthy conditions present during any phase of the disaster (i.e., pre-disaster preparations, during the actual disaster, or post-disaster during cleanup after a disaster), including disaster-caused exacerbation of pre-existing conditions.

- FEMA staff may coordinate with the SLTT government to obtain the required signed statement.
- FEMA staff will not share the applicant's personally identifiable information (PII) when obtaining documentation on the deceased.
- When FEMA receives a signed statement from a medical examiner, coroner, or other certifier that does not clearly state the disinterment, death, or underlying injury causing the death was attributed either directly or indirectly to the emergency or disaster, FEMA will work to obtain clearer certification.
- Receipts or verifiable estimates indicating the applicant incurred or will incur eligible interment, reinterment, or funeral expenses.
- Documentation of burial insurance and/or any forms of funeral assistance received from voluntary agencies, government agencies, or other entities.
- For reinterment only, documentation proving that the disinterment occurred in a privately-owned, licensed cemetery or burial facility (such as an association or community cemetery or burial facility) and the cemetery or burial facility is not responsible for reintering displaced remains.
 - In the event of disinterment, FEMA will consider requests that include a funeral home representative or cemetery representative statement indicating that the cause of disinterment was a direct result of the disaster.
 - FEMA may coordinate with the SLTT government to obtain required documentation.

Limitations and Exclusions

- FEMA may provide assistance to the applicant only up to the Funeral Assistance amount established by the STT government.
- For multiple family member deaths, FEMA may provide assistance up to the Funeral Assistance amount established by the STT government on the ONA Administrative Option Selection Form. The STT government may set the assistance amount per death or per household. FEMA may provide assistance to the applicant up to the financial ONA maximum award for the fiscal year in which the disaster was declared.
- FEMA will not provide assistance for any of the following:
 - Obituaries
 - Flowers
 - Printed materials such as banners, programs, or register books
 - Catering services, including food
 - Transporting applicant or others to site(s) of funeral services, interment, or reinterment
 - Gratuities

2. Medical and Dental Assistance

FEMA provides financial assistance under the ONA provision of the IHP to individuals and households with medical or dental expenses caused by a disaster.¹⁶³ Unlike most other forms of IHP assistance, an applicant seeking Medical and Dental Assistance does not need to live in the Presidentially-declared disaster area to be considered for the assistance. Any person who incurs disaster-caused medical or dental expenses may apply for and, if eligible, receive Medical and Dental Assistance.

Conditions of Eligibility

In addition to meeting general conditions of eligibility (see [Chapter 3, II.](#)), applicants must meet the following conditions in order to receive Medical and Dental Assistance:

- The medical or dental injury or expense must be a direct result of the disaster, as verified by a written and signed statement by the applicant, medical provider, or dental provider.
 - Eligible expenses include costs associated with:
 - Injury or illness caused by the disaster.
 - Pre-existing injury, disability, or medical condition aggravated by the disaster.
 - Replacement of prescribed medication.
 - Loss or damage of personal medical or dental equipment.
 - Medical or dental insurance deductibles and co-payments for eligible expenses.
 - Loss or injury of a service animal.
- Medical or dental expenses will not be eligible for FEMA reimbursement if they are covered by insurance or any other source.
- Expenses related to the loss or injury of a service animal must be a direct result of the disaster. Eligible expenses may include costs associated with:
 - Veterinary expenses for disaster-caused injuries.
 - Replacement and/or training costs.
 - Lost or damaged equipment that enables the service animal to fulfill its function (e.g., specialized leash, harness, or vest).



Disability

The term “disability” means, with respect to an individual: (A) A physical or mental impairment that substantially limits one or more major life activities of such individual; (B) A record of such impairment; or (C) Being regarded as having such an impairment.

Major life activities include, but are not limited to, caring for oneself, performing manual tasks, seeing, hearing, eating, sleeping, walking, standing, lifting, bending, speaking, breathing, learning, reading, concentrating, thinking, communicating, and working.

(Source: 42 U.S.C. § 12102)

Required Documentation

Required documentation must indicate the expense was caused by the disaster, is medically required, and includes the amount of expense.

Disaster-caused injury or illness documentation includes both of the following:

- Itemized bills, receipts, or estimates from the medical or dental provider or pharmacy;
- A written and signed statement from a medical or dental provider, including the date of disaster-caused injury and expenses necessary for recovery

Replacement of prescribed medication documentation includes all the following:

- A written and signed statement by the applicant or the applicant's medical or dental provider verifying the loss was caused by the disaster;
- A written and signed statement from a medical or dental provider verifying the prescription is required and was previously prescribed to the applicant or a household member; and
- Receipts or other verifiable documentation from the pharmacy showing the replacement cost of the prescribed medication

Loss or damage of medical or dental equipment documentation includes all the following:

- A written and signed statement by the applicant or the medical or dental provider verifying the loss was caused by the disaster;
- A written and signed statement from a medical or dental provider verifying the applicant or household member required the medical or dental equipment prior to the disaster; and
- Itemized bills, receipts, or estimates showing repair or replacement cost of the medical or dental equipment

Required documentation verifying the loss or injury of a service animal includes all the following:

- A written and signed statement by the applicant, medical provider, or veterinary provider verifying the service animal's loss or injury was caused by the disaster;
- A written and signed statement from a medical provider verifying the applicant or household member required the service animal for a disability prior to the disaster;
- A statement from the applicant, medical provider, or other representative explaining the type of task or work performed by the service animal; and
- Itemized bills, receipts, or estimates showing expenses related to the service animal's loss or injury

Medical or dental insurance settlements must be provided if the applicant has medical or dental insurance.



Medical and Dental Providers

Medical or dental provider may include audiologists, rehabilitation specialists, or state-based agencies who can verify an applicant's disability and need for a device or equipment.

Limitations and Exclusions

- Medically-required generators purchased or rented to power equipment necessary for an existing medical condition may be considered under Assistance for Miscellaneous Items rather than Medical and Dental Assistance. For additional information, see [Chapter 3, VI.B.4.](#)
- IHP assistance for replacing lost or damaged medical or dental equipment is limited to items of similar quality and function as the item being replaced.
- IHP assistance for medical and dental services does not include medically unnecessary procedures (e.g., procedures designed to enhance appearance, such as teeth whitening).
- A limited number of accessible items are available for qualified applicants with disabilities under Personal Property Assistance. To be eligible, these items must have been owned prior to the disaster and sustained disaster-caused damage or loss. For additional information, see [Chapter 3, VI.C.1.](#)
- IHP assistance for service animals is limited to service dogs and miniature horses that perform a qualified task for a person with a disability, as defined by the ADA of 1990 (ADA, as amended, 2008). The ADA defines service animal as “any dog [or miniature horse] that is individually trained to do work or perform tasks for the benefit of an individual with a disability.”
- A service animal must be required because of a disability and perform a functional task for the applicant or a member of the household.
- IHP assistance is not available for therapy animals or emotional support animals.

3. Child Care Assistance

FEMA provides financial assistance under the ONA provision of the IHP to eligible individuals and households who have a disaster-caused increased financial burden for child care.¹⁶⁴ FEMA will award payment for Child Care Assistance for the household’s increased financial burden for up to eight cumulative weeks of child care, plus any eligible expenses, or the maximum amount of assistance for Child Care Assistance identified by the STT government, whichever is less.

FEMA may provide financial assistance to address increased disaster-caused child care expenses for eligible households with:

- Children aged 13 and under; and/or
- Children with a disability, as defined by Federal law,¹⁶⁵ up to age 21, who need assistance with activities of daily living.



Activities of Daily Living (ADL)

Activities of daily living are routine activities that people tend to do every day without needing assistance. There are six basic ADLs: eating, bathing, dressing, toileting, transferring (walking), and continence.

The respective STT government must establish the maximum amount of Child Care Assistance on a per-child or per-household basis as part of the annual ONA Administrative Option Selection process.

Conditions of Eligibility

In addition to meeting general conditions of eligibility (see [Chapter 3, II.](#)), applicants must have a disaster-caused increase in financial burden for child care, regardless of whether child care expenses were required prior to the disaster, because:

- The applicant’s gross household income has decreased as a direct result of the disaster; or
- The applicant’s child care expenses have increased as a result of the disaster.

Applicants must certify they cannot utilize child care services provided by any other source (e.g., other Federal assistance for child care, private employer child care services) in order to qualify for Child Care Assistance.

For applicants with child care expenses prior to the disaster, FEMA compares the percentage of the household’s gross income spent for child care expenses before the disaster to the percentage spent following the disaster to determine if the post-disaster child care costs create a financial burden. For example, if the household’s pre-disaster income was \$3,500 per week and pre-disaster child care costs were \$750 per week, child care costs were 21.4% of the household’s income pre-disaster. If the post-disaster income is \$3,500 per week and post-disaster child care costs are \$1,000 per week, child care costs are now 28.6% of the household’s income post-disaster.

Figure 31: Example - Comparison of Pre- and Post-Disaster Child Care Costs

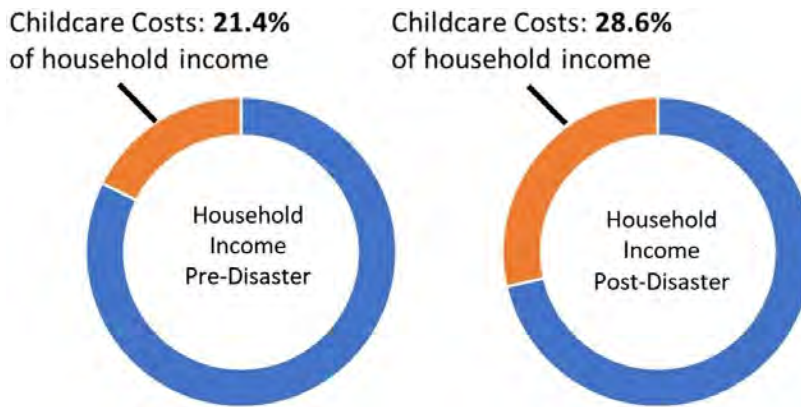

If the percentage of household gross income spent on child care post-disaster is higher than the percentage of household gross income spent on child care pre-disaster, the household has an increased financial burden for child care and may be eligible for assistance to cover the increase. In the example above, the percentage of the household’s gross income spent on child care is 7.2% higher than the percentage of the household’s gross income spent on child care pre-disaster. This household may be eligible to receive the difference in pre- and post-disaster household income spent on child care.

The applicant’s post-disaster child care provider must be licensed, regulated, or registered under applicable SLTT government law to qualify for assistance.

The following items are eligible expenses for Child Care Assistance:

- Standard child care service fees, including personal assistance services that support activities of daily living for children with disabilities.
- Registration and health inventory fees may be eligible expenses only for applicants who require a new child care service provider.



Registration Fee

A registration fee is a one-time fee when registering an eligible child at an authorized child care provider. A health inventory fee is a medical office fee for processing required medical paperwork as part of the registration process.

Required Documentation

Details regarding information that must be included on each type of documentation are listed in *Figure 32*.

For FEMA to determine a disaster-caused need for Child Care Assistance, an applicant who had child care expenses pre-disaster must submit:

- Pre- and post-disaster gross household income documentation.
- Pre-disaster receipts, contract, or signed letter from the child care provider for child care expenses, if receipts or contract cannot be located.
- Post-disaster receipts or estimates for child care fees, registration, and/or health inventory fees.
- A post-disaster child care contract or agreement.
- A post-disaster child care provider's license, if the information cannot be located within a respective SLTT government's licensed provider database.
- Individualized Educational Plan (IEP), 504 plan,¹⁶⁶ or medical professional's statements, if applicable, to verify disability for children up to age 21 who need assistance with activities of daily living.



IEPs and 504 Plans

IEP: A document developed for each public-school child who needs special education. An IEP defines the individualized objectives of a child who has been determined to have a disability, as defined by Federal regulations. As long as a student qualifies for special education, the IEP is mandated to be regularly maintained and updated up to the point of high school graduation, or prior to the 21st birthday.

504 Plan: This type of plan falls under Section 504 of the Rehabilitation Act of 1973. A 504 plan outlines how a child's specific needs are met with accommodations, modifications and other services. These measures "remove barriers" to learning.

- A signed, written statement from the applicant affirming:
 - The applicant is not receiving assistance for child care expenses from any other source; and
 - The expected length of time the applicant will have a disaster-caused need for Child Care Assistance.

An applicant who did not have child care expenses pre-disaster, and has incurred or will incur child care expenses as a result of the disaster, must submit:

- Post-disaster receipts or estimates for child care fees, registration, and/or health inventory fees.
- A post-disaster child care contract or agreement.
- A post-disaster child care provider's license, if the information cannot be located within a respective SLTT government's licensed provider database.
- IEP, 504 plan, or medical professional's statements, if applicable, to verify disability for children up to age 21 who need assistance with activities of daily living.
- A signed, written statement from the applicant affirming:
 - The applicant is not receiving assistance for child care expenses from any other source; and
 - The expected length of time the applicant will have a disaster-caused need for Child Care Assistance.

Figure 32: Child Care Assistance Documentation

Type of Documentation	Documentation Requirements
Pre-disaster child care expense receipts, contract, or signed letter from child care provider, if receipts or contract cannot be located.	<ul style="list-style-type: none"> • The name of the child/ren receiving care. • Provider’s name, address, and telephone number. • Time period covered and total child care expenses for that time period. • Signature of child care provider and applicant.
Proof of pre-disaster and current post-disaster income for the individual(s) responsible for child care expenses	<p>Examples include, but are not limited to:</p> <ul style="list-style-type: none"> • Recent pay stubs. • W-2 forms or tax returns from most recent tax year. • Documentation of self-employment, if applicable. • Documentation of government assistance, including Social Security.
Verification of the child care provider’s license	<p>Applicant does not need to submit if the information can be located within a respective STT government’s licensed provider database.</p>
Individual Educational Program Plan, 504 plan, or medical professional’s statement	<p>Verifies a disability for children up to age 21 who require assistance with activities of daily living. If a child with a disability has not graduated from high school, they are eligible for education services under the Individuals with Disabilities Education Act (IDEA) until age 21. A child eligible under IDEA will have an IEP that documents the educational services. Children who are not eligible for an IEP, but still need some educational support, may have a 504 plan.</p>

Limitations and Exclusions

- FEMA limits Child Care Assistance to up to eight cumulative weeks per child or per household or the maximum amount of assistance established by the STT government, whichever is less.
- FEMA will only provide Child Care Assistance to one applicant on behalf of the child(ren).
- If a child is a member of multiple households, FEMA will only award assistance to the primary custodial parent/guardian responsible for child care costs after the disaster.
- FEMA will not provide assistance for any of the following:
 - Fees for extra-curricular activities and additional services (e.g., school photographs, field trips)
 - Fees not directly related to the day-to-day child care services provided to the eligible child (e.g., prepared lunches, snacks, facility-provided linens, etc.)
 - Fuel expenses related to transporting the child to and from the child care provider (e.g., school bus service)
 - Education services (e.g., after-school tutoring)
 - Medical care or services
 - Recreational camps or clubs (e.g., after-school clubs, overnight camps)

4. Assistance for Miscellaneous Items

FEMA provides financial assistance under the ONA provision of the IHP to individuals and households with certain disaster-caused miscellaneous expenses.¹⁶⁷ Eligible items must be purchased or rented after the incident to assist with the applicant's disaster recovery, such as gaining access to the property or assisting with cleaning efforts. Items damaged by the disaster that were owned prior to the disaster will be considered under Personal Property Assistance. STT governments, in consultation with FEMA, have identified standard miscellaneous line items. However, the STT government may elect not to include all these items as eligible for reimbursement:

- Carbon Monoxide Detector
- Chainsaw
- Dehumidifier
- Generator (see [Chapter 3, VI.B.4](#)) under this section's Limitations and Exclusions)
- Humidifier
- Smoke Detector
- Weather Radio

STT governments may request additional miscellaneous line items on the ONA Administrative Option Selection Form, during any non-disaster time period or within 72 hours of a major disaster declaration.¹⁶⁸

Conditions of Eligibility

In addition to meeting general conditions of eligibility (see [Chapter 3, II.](#)), applicants must meet the following conditions in order to receive Assistance for Miscellaneous Items:

- The expense must be a direct result of the disaster.
- The item must have been purchased or rented within 30 days after the incident start date or up to the last day of the incident period, whichever is greater.
- Generator exception: The reimbursement period starts the day the Governor or Tribal Chief Executive declares a State of Emergency and ends at the incident period closure date identified by FEMA in the Federal Register, or if warranted due to extraordinary circumstances, the date commercial power is restored to the applicant's primary residence as verified by the FEMA JFO or commercial power provider.
- Applicants must provide an itemized receipt or equipment rental agreement for eligible expenses.
- The expense must not be covered by insurance or provided by any other source.

Limitations and Exclusions

- Prior to the disaster, if the applicant owned the eligible miscellaneous item and the item was damaged by the disaster, the item will be considered under Personal Property Assistance.
- Assistance for Miscellaneous Items is limited to the quantity established for the item by the STT government on the ONA Administrative Option Selection Form.
- If the pre-disaster primary residence is located within a CBRS Unit, the applicant may not be considered for Assistance for Miscellaneous Items except for expenses to purchase or rent items required to power life-sustaining medical equipment (e.g., generators).
- Generator expenses only:
 - The generator must be purchased or rented to power a medically-required piece of equipment, including medically-required refrigerators.
 - The generator must be purchased or rented due to a disruption in electrical utility service as a result of the disaster.
 - The applicant must submit a statement from a medical services provider, indicating the equipment is medically necessary.



Power lines in NY damaged by Hurricane Irene and Tropical Storm Lee.

- The allowable award amount for generators is limited to the prevailing retail or rental rate for a 5.5 kw-sized generator, as identified by FEMA.
- The IA Division Director may waive one or more conditions of eligibility during extraordinary circumstances (e.g., sustained power outage during a period of sub-freezing temperatures) when determined to be in the public's interest.
- Chainsaw expenses only:
 - The chainsaw must be purchased or rented to gain access to and/or remove hazards from the home.



A home in Arkansas is damaged by a fallen tree.

5. Moving and Storage Assistance

FEMA may provide financial assistance under the ONA provision of the IHP to individuals and households for moving and storage expenses incurred on or after the incident period start date to avoid additional disaster damage.¹⁶⁹ Generally, these expenses include those related to: (1) storage of personal property in a storage unit or temporary housing unit while repairs are being made to the primary residence and returning the property to the applicant's primary residence, or (2) moving the items to the individual's or household's new primary residence.¹⁷⁰

FEMA may provide assistance with eligible moving and storage expenses through the period of assistance or up to the financial ONA maximum award, whichever comes first.

Conditions of Eligibility

In addition to meeting general conditions of IHP eligibility (see [Chapter 3, II.](#)), applicants must meet the following conditions in order to receive Moving and Storage Assistance:

- The applicant's primary residence was rendered uninhabitable due to the disaster.
- The property being moved and/or stored is considered as essential personal property and/or household goods (such as appliances and furniture).
- The applicant is moving and/or storing essential household goods to prevent additional damage and returning the items to the individual's or household's primary residence or moving the items to the individual's or household's new primary residence.

Eligible Expenses: Moving and Storage Assistance may be provided for, but is not limited to, all of the following expenses:

- Costs for commercial moving labor
- Moving truck rental fee
- Fuel for the rental vehicle
- Costs for tape and boxes
- Commercial storage unit fees
- Associated sales taxes

Ineligible Expenses: All the following expenses are ineligible:

- Moving and storage of recreational items (e.g., fishing gear, canoes, jet skis)
- Costs incurred for the moving and storage of items as a preventative measure prior to the disaster
- Costs covered by another source (e.g., insurance, SBA disaster loan)
- Expenses for essential personal property that is permanently moved out of the damaged pre-disaster residence and will not be returned to the applicant's primary residence or to the applicant's new primary residence.
- Optional insurance and security deposits listed on applicant's receipts, bills, or estimates

Required Documentation

Applicants must submit:

- Receipts, bills, or estimates with associated dates for the moving expenses.
- Receipts or bills with associated dates for storage expenses.
- Statements with all the following:
 - The reason(s) moving and storage expenses were required
 - A description of the essential household goods being stored
 - Information indicating the essential household goods are being stored while repairs to the primary residence are being made
 - Information indicating the essential household goods will be returned to the primary residence or to the individual's or household's new primary residence



Flood Insurance Policies

Many flood insurance policies provide up to \$1,000 in moving expenses. As FEMA is unable to duplicate assistance from other sources, applicants who have flood insurance will have to submit documentation to show they have exhausted funds allocated under their policy for moving expenses prior to being considered for FEMA's Moving and Storage Assistance.

Limitations and Exclusions

When the cause of damage is flooding and the applicant failed to maintain flood insurance as required as a condition of receiving previous Federal assistance, FEMA is unable to provide assistance for the first \$1,000 of moving expenses.

6. Critical Needs Assistance

FEMA may provide financial assistance under the ONA provision of the IHP to applicants who have immediate or critical needs because they are displaced from their primary residence or to applicants who need assistance in order to leave their pre-disaster primary residence to temporarily shelter elsewhere. Immediate or critical needs are life-saving and life-sustaining items including, but not limited to: water, food, first aid, prescriptions, infant formula, diapers, CMS, DME, personal hygiene items, and fuel for transportation.

Program Request and Approval

FEMA's IADD may authorize CNA when the affected STT government submits a written request with justification, to implement CNA. The request must be submitted within 14 days from the date of the Presidential disaster declaration. This form of assistance may be considered for specific geographic areas (i.e., counties or ZIP codes), identified by the STT government, within the declared disaster when the request demonstrates:

- Applicants are displaced due to restrictions placed by the SLTT government officials (e.g., evacuation advisory, inaccessibility);
- Shelters in the area do not meet the needs of the displaced population; and
- Community and life-sustaining services within a reasonable distance from the area are limited due to the disaster-caused impact.

Based on the affected STT government's request, the IA Division Director may authorize a CNA eligibility period of up to 30 days from the Presidential disaster declaration. When necessary based on applicant need, the IA Division Director may extend the CNA eligibility period if requested by the affected STT government.

Conditions of Eligibility

Applicants will be considered for assistance if all the following apply:

- They register for FEMA assistance within the CNA eligibility period established for the declared disaster;
- They pass FEMA's identity and occupancy verification process;
 - The IADD may waive occupancy verification in locations where automated verification of public records is limited.
- They are displaced from their pre-disaster primary residence as a result of the disaster, or they are sheltering in their pre-disaster residence and report a need to shelter elsewhere at registration;

- At registration, they assert that they have critical needs and request financial assistance for those needs and expenses; and
- Their pre-disaster primary residence is located in the designated geographic area requested by the STT government and approved by the IADD for CNA.
- They report damage that may impact the habitability of their home.

Limitations and Exclusions

- Applicants temporarily residing in correctional facilities or secondary residences are not eligible for CNA.
- Applicants will not receive CNA if there are any unresolved high-risk fraud indicators associated with their registration.
- Applicants who apply during the eligible period and resolve all issues impacting eligibility prior to the end of the registration period and any approved extensions may receive CNA. Applicants that resolve ineligibility issues after the close of the registration period will not receive a CNA payment.
- Unless otherwise authorized by the IA Division Director and the respective STT government, CNA is limited to \$500 per eligible household and will be awarded as a one-time award. This amount is based on the reasonably prudent cost of life-saving and life-sustaining items that a household may need immediately upon displacement from their home.

7. Clean and Removal Assistance

FEMA may provide a limited amount of financial assistance to homeowners with disaster-caused real property damage who do not qualify for Home Repair Assistance because the damage did not render the home uninhabitable. Clean and Removal Assistance (CRA) is intended to ensure contamination from floodwaters is addressed in a timely manner to prevent additional losses and potential health and safety concerns. Individual property owners will be responsible for performing or contracting for services to remove contaminants and disinfect surface areas of their homes that have been affected by floodwater.

Program Request and Approval

An affected STT government must submit a written request to FEMA to implement CRA. The GAR or TAR must submit a written request for CRA to the FCO. CRA may only be requested in disasters where “flood” is listed as an incident type. CRA must be approved by the RA prior to implementation. The eligibility period for CRA will correspond to the standard FEMA registration period of 60 days, but will not include extension periods unless specifically authorized by the RA.

Conditions of Eligibility

In addition to meeting general conditions of eligibility (see [Chapter 3, II.](#)), applicants must meet the following conditions in order to receive CRA:

- The pre-disaster primary residence is located in an area designated for Individual Assistance.
- The applicant has at least one real property line item recorded during inspection as flood-damaged.
- The pre-disaster primary residence is not covered by insurance for flood damage, including flood or mobile home insurance, at the time of the disaster.
- The applicant receives a denial indicating the disaster-damaged primary residence was safe to occupy.

Limitations and Exclusions

- CRA is limited to \$550 per eligible household. This amount is based on the average historical cost of cleaning, sanitizing, and removing floor covering after a flood.
- CRA will be awarded as a one-time payment.
- The CRA award will be deducted from any subsequent Home Repair Assistance award.
- If FEMA determines that the subsequent Home Repair Assistance award would be less than the \$550 CRA award, the applicant will not receive additional funds.

C. SBA-Dependent

The types of assistance described in this section are SBA-dependent. Applicants who were referred to the SBA but who did not qualify for an SBA loan, or who were approved for a partial loan but the amount of the loan was insufficient to meet the applicant's disaster expenses or serious needs, may be referred back to FEMA to determine their eligibility for Personal Property Assistance, Transportation Assistance, and a Group Flood Insurance Policy (GFIP) certificate.

Applicants who withdraw from the process or decline a loan from the SBA will not be referred back to FEMA for assistance with SBA-Dependent ONA.



A woman helps her neighbor clean out a flood damaged home in Cedar Rapids, Iowa.

1. Personal Property Assistance

FEMA may provide financial assistance under the ONA provision of the IHP to repair or replace personal property damaged or destroyed due to a disaster.¹⁷¹ The *ONA Administrative Option Selection Form* includes a list of eligible items, also known as the Standard Personal Property Line Items list that may be considered for assistance. The affected STT government has the ability to request that items be added to or removed from the list within 72 hours of an IA declaration.

FEMA and the affected STT government establish a maximum quantity that may be awarded for each personal property item. FEMA calculates the award amount for each item according to the consumer price index data for items of average quality, size, and capacity in the area where the damage occurred. The assistance is intended to meet the basic needs of the household, not to restore all personal property items to a pre-disaster condition.

When applicants reside in the same damaged pre-disaster residence and are not classified by FEMA as roommates or boarders, the owner or head of household will be considered responsible for the personal property in the common living areas up to the quantity limit. However, a household member could be eligible if the owner, head of household, or landlord has not met the item quantity limit. The household members may be awarded the minimum amount of assistance to meet the household needs, not to exceed the quantity limit. For more information about roommates and boarders see [Chapter 3, II](#).

FEMA will record personal property as being unaffected or needing repair or replacement during inspection of the applicant's damaged primary residence. FEMA assistance to repair and replace personal property falls within the following categories:

- **Appliances:** Includes standard household appliances, such as a refrigerator, washing machine, etc.
- **Clothing:** Essential clothing needed due to overall loss, damage, or contamination.
- **Room furnishings:** Standard furnishings found in a bedroom, kitchen, bathroom, and living room.
- **Essential Tools:** Tools and equipment required by an employer as a condition of employment and items required as a condition of an applicant's or household member's education.



Non-Typical Appliances

For processing purposes, FEMA identifies certain items as “appliances” that may not be considered a typical appliance to the general public. Items that fall into this category include:

- Children's strollers and toys
- Everyday dining tables
- Twin beds
- Property for applicants with access or functional needs, such as accessible toilet seats, beds, etc.

Conditions of Eligibility

In addition to meeting general conditions of eligibility (see [Chapter 3, II](#)), applicants must meet the following conditions in order to receive Personal Property Assistance:

- The item needs to be repaired or replaced due to disaster damage.
- The occupants of the household have an unmet disaster-related need for the damaged item. FEMA may not provide assistance if the applicant can meet that need with another similar item in their possession or available to the household.
- The item was owned and being used by occupants of the household.
 - FEMA does not provide assistance for furnishings and/or appliances provided by a landlord.

- Items used by guests and relatives who were not members of the pre-disaster household are not eligible for assistance.

Applicants must also meet specific eligibility requirements for each category of item for which they are requesting Personal Property Assistance. These include:

- **Appliances:** Assistance is based on the number and type of household appliances in need of repair or replacement. Applicants may receive assistance for two appliances that serve a similar purpose or function (e.g., a range and a microwave).
- **Clothing:** Assistance is based on a set dollar amount per person (intended to provide funds for up to seven days of clothing needs) and the number of household members requiring clothing, as recorded during FEMA inspection. FEMA may provide assistance for clothing when existing clothing has been destroyed, is physically gone (e.g., blown away), or contaminated by chemicals or sewer backup as a result of disaster. FEMA expects applicants to clean clothing soaked by wind-driven rain, seepage, or flood waters. Stored clothing is generally not eligible for assistance.
- **Room Furnishings:** Assistance is based on the level of damage to furnishings within specific rooms of the residence as recorded during FEMA inspection. The rooms must be one of the four types required to meet the needs of a typical household: kitchen, living room, bathroom, or bedroom.
- **Essential Tools:** Assistance is based on a need to replace disaster-damaged essential tools, supplies, equipment, items required by an employer as a condition of employment, or required for education. This includes disaster-damaged tools and equipment, or other items required for a specific trade or profession, not provided or supplied by the employer. Tools, uniforms, computers, supplies, or other items used for self-employment are not eligible for IHP assistance.

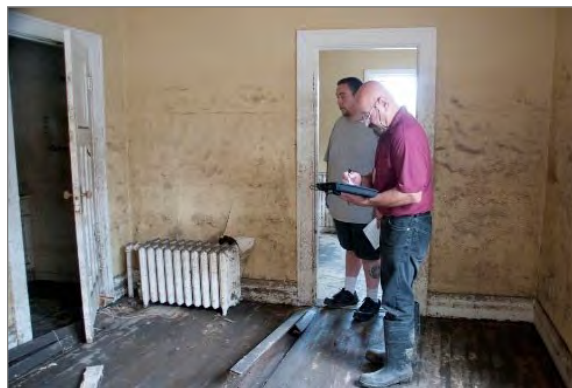

FEMA inspector records disaster damage at a survivor's home.

Eligible essential tool items are listed below:

- Schoolbooks/Supplies: Equipment and supplies required to be provided by the applicant for educational courses or schooling, including home schooling, college, and trade school courses.
- Uniforms: Required for school or work when the applicant is responsible for replacement of the uniforms.
- Computers: Required by a school or an employer when the applicant is responsible for the replacement of the computer.
- Occupational Tools: Essential tools and equipment, not provided or supplied by an employer, and required by an employer as a condition of employment.

- Applicants may be asked to provide the following documentation for essential tools:
 - A statement from the employer on company letterhead documenting the applicant is required to provide their own tools or computer as a condition of employment.
 - A statement on school letterhead documenting a computer is required as a condition of education and the school does not provide access to computers to use outside of class, such as a school computer lab.
 - An itemized list of the tools required by the employer, also on company letterhead.
 - An itemized list of each tool required and a verifiable statement, estimate, or bill from the place of the potential purchase stating that the damage was caused by the disaster.
- **Accessible Items:** FEMA also provides assistance for damaged personal property items required for qualified applicants with disabilities. The list includes accessible beds, raised toilet seats, accessible refrigerators, accessible washers, and computers or adaptive technology when utilized as the sole means of communication for a household member with a disability. Motorized and non-motorized wheelchairs, shower chairs, visual/vibrating fire signals, and walkers, are also eligible items.
 - If an applicant has additional assistive devices not included in the list above, they may request assistance to replace those items under the Medical and Dental Assistance category of ONA (see [Chapter 3, VI.B.2.](#)).
 - If the cost to repair or replace an ADA Personal Property item exceeds the award amount, applicants may request assistance for the additional amount by providing the following:
 - A written or signed statement from a medical provider verifying the applicant or household member required the item prior to the disaster; and
 - An itemized bill, receipt, or estimate showing the repair or replacement cost of the item.

Limitations and Exclusions

- Applicants incarcerated at the time of the disaster who incur disaster-caused damage to their personal property within their unit at the correctional facility or detention center are ineligible for IHP assistance. Prisoners are legally entrusted to the corrections institute which is responsible for safeguarding their persons and providing for their needs.
- Financial assistance for flood-damaged personal property in basements is limited to both of the following:
 - Washers and dryers
 - Essential personal property in rooms required for the occupation of the dwelling (for example, occupied bedrooms, a bathroom required for the occupied bedroom, a sole kitchen or living room).

2. Transportation Assistance

FEMA may provide financial assistance under the ONA provision of the IHP to individuals and households with disaster-caused vehicle repair or replacement expenses.¹⁷² Unlike most other forms of IHP assistance, an applicant seeking Transportation Assistance does not need to live in the Presidentially-declared disaster area to be considered for the assistance.



A car is surrounded by floodwaters.

The affected STT government uses the ONA Administrative Option Selection Form to establish the maximum amount of Transportation Assistance (i.e., Transportation Repair and Transportation Replacement) that may be awarded. The amount of Transportation Repair and Replacement Assistance awarded is based on the degree of damage and the STT government's repair and replacement maximum.

Conditions of Eligibility

In addition to meeting general conditions of eligibility (see [Chapter 3, II.](#)), applicants must meet the following conditions in order to receive Transportation Assistance:

- The vehicle sustained disaster-caused damage, and the damage occurred within the Presidentially-declared disaster area.
- The damaged vehicle is an approved vehicle type; eligible vehicles include but may not be limited to vans, trucks, sport utility vehicles, and cars.
 - Other modes of transportation may be added to the ONA Administrative Option Selection Form by the STT government during any non-disaster time period or within three days of a major disaster declaration. This may include boats, motorcycles, golf carts, or other non-standard modes of primary transportation.
- The damaged vehicle is in compliance with its STT government's registration and insurance requirements at the time of the disaster.
- The damaged vehicle is owned or leased (i.e., not a rental vehicle) by the applicant, co-applicant, or household member.



Vehicle Damage Levels

Destroyed Vehicle is a vehicle declared a total loss due to disaster-caused damages (e.g., flood water covered the engine, vehicle was crushed by a fallen tree or was burned).

Repairable Vehicle is a vehicle that sustained disaster-caused damage affecting the drivability or safety of the vehicle (e.g., broken windshield, window glass, mirror, or headlight assembly; minor mechanical repairs; medically-required repairs).

Vehicle with Cosmetic Damage is a vehicle with disaster-caused damage that does not affect the drivability or safety of the vehicle in any way (e.g., minor dents, scratches, and other similarly low

Required Documentation

Generally, FEMA will verify vehicle damage during an on-site inspection and record it as repairable or destroyed. If the vehicle is not available at the time of inspection, the vehicle was recorded destroyed by the on-site inspector, or if the applicant does not receive an on-site inspection, the applicant must submit:

- A copy of the vehicle registration valid at the time of the disaster for the damaged vehicle(s);
- A list of all vehicle(s) owned (year, make, and model) and a brief description of damage for each vehicle;
- Proof of insurance policy showing type of coverage or proof the vehicle meets the STT's minimum insurance requirement;
- Insurance settlement, denial, or statement that insurance coverage does not exist;
- **For vehicle repair:** a verifiable bill, receipt, or estimate from a mechanic that:
 - Confirms the damage is disaster-caused;
 - Identifies repair or replacement costs (e.g., parts, service, and labor); and
 - Includes the mechanic's contact information.
- **For vehicle replacement:** documentation from an SLTT government confirming the vehicle was salvaged due to the disaster.
- If the damaged vehicle included medically-required modifications that exceed the Transportation Assistance maximum repair or replacement amount, as applicable, the applicant may request assistance for those modifications under the Medical and Dental Assistance category of ONA (see [Chapter 3, VI.B.2.](#)). Applicants must provide the following documentation related to any medically-required vehicle modifications and the repair or replacement cost of those items, as appropriate, including:
 - A written or signed statement from a medical provider verifying the applicant or household member required the item prior to the disaster; and
 - An itemized bill, receipt, or estimate showing the repair or replacement cost of the component or modified vehicle, as appropriate.



Vehicle Repair Expenses

Eligible repair expenses based on bills, receipts, and estimates may include but are not limited to:

- Costs for labor
- Service fees (e.g., battery recharge or wheel re-alignment)
- Repair estimates and vehicle towing expenses
- The repair/replacement of vehicle parts when repairs for drivability and safety are required (includes paint and/or body work and carpet)
- Medically-required modifications (e.g., ramp, lift, hand controls)

Limitations and Exclusions

- FEMA will not award assistance to repair or replace an operational vehicle. An operational vehicle is defined as a vehicle that may need cosmetic repairs or incurred minimal damage but is in compliance with its STT government's registration and insurance requirements at the time of the disaster and can be legally driven.
- Assistance is usually limited to one vehicle. However, in instances where any additional unaffected and operational vehicles owned by members of the household are not sufficient to meet the needs of the household, FEMA may award assistance to repair or replace a second damaged vehicle. Any additional vehicles would be required to meet all applicable conditions of eligibility, as referenced above. Additionally, the applicant must certify in writing that the damaged vehicle is essential for the household's daily usage, outline the relevant circumstances, and explain the serious need for a second vehicle.

3. Group Flood Insurance Policy

The Group Flood Insurance Policy¹⁷³ refers to a flood insurance policy established under the NFIP regulations.¹⁷⁴ As part of the effort to reduce future expenses from floods, FEMA directly purchases GFIP certificated on behalf of applicants who are required to purchase and maintain flood but who may not otherwise be able to purchase a policy.

In Joint and State Option disasters, the STT government directly purchases the GFIP as part of their administration of ONA. The premium for a three-year certificate of coverage is \$2,400¹⁷⁵ and counts towards an applicant's ONA financial maximum award.¹⁷⁶ The GFIP is a policy that is established for each disaster declaration that results from flooding and authorizes the provision of IA.



GFIP Overview

- GFIP certificates provide up to three years of flood insurance coverage for real property and personal property items insurable under the NFIP.
- The master GFIP policy term is for 36 months and begins 60 days after the date of the Presidential disaster declaration. However, individual coverage becomes effective after a 30-day waiting period, which starts on the day NFIP receives the applicant's name and premium payment from either the SLTT government or FEMA.
- The coverage amount of the GFIP policy is equal to the combined value of the Housing Assistance and ONA financial maximum awards.

Conditions of Eligibility

In addition to meeting general conditions of eligibility (see [Chapter 3, II.](#)), applicants must meet the following conditions in order to be considered for a GFIP certificate:

- FEMA verifies that damage to the applicant's property is caused by flooding and the damaged items are insurable under NFIP.
- The applicant's damaged residence is located in an SFHA.
- The applicant's damaged residence is not located in a sanctioned community, CBRS area, or OPA.
- The applicant does not have a previous requirement to maintain flood insurance as a condition of receiving IHP assistance.
 - If a subsequent disaster occurs during the 30-day waiting period for the purchased flood insurance to become effective, the applicant is considered compliant and eligible for IHP assistance.
- The applicant is referred to FEMA for SBA-dependent ONA.
 - Applicants who accept an SBA loan during the disaster in which a flood insurance requirement is set will not be considered for a FEMA-purchased GFIP certificate.
 - Applicants who were referred to the SBA, did not qualify for an SBA loan, and were referred back to FEMA may be considered for a FEMA-purchased GFIP certificate.
- The applicant is eligible for Home Repair Assistance, Home Replacement Assistance, or Personal Property Assistance, prompting the requirement to maintain flood insurance on the damaged residence and initiating the GFIP.
- An eligible applicant whose pre-disaster primary residence is located within an OPA and an SFHA may only be considered for a GFIP certificate if they also meet the following conditions:
 - A legally valid building permit for the construction of the applicant's pre-disaster primary residence was issued prior to November 16, 1991; and
 - The applicant's pre-disaster primary residence was built (walled and roofed) no later than November 16, 1991; and
 - The applicant's pre-disaster primary residence was not substantially improved or substantially damaged on or after November 16, 1991.

Applicant Notification and Response

- Pre-disaster owners included in the GFIP receive notification from FEMA stating they have been included in the policy as well as a “Certificate of Flood Insurance;” applicants do not receive a copy of the actual policy. Applicants do not have the ability to decline the GFIP.
- Pre-disaster renters will only receive a GFIP certificate if they notify FEMA within six months of receiving a GFIP notification letter that they have moved back or intend to move back to their pre-disaster residence.
 - GFIP certificates are not transferable to a new renter of a rental unit and are not transferable to a new rental address.
- FEMA gives applicants a 60-day notice of policy expiration and a final notice of termination of coverage. When the GFIP expires, the applicant is responsible for purchasing and maintaining flood insurance on their own. Failure to maintain flood insurance will affect applicant eligibility for future disaster assistance.

Limitations and Exclusions

- If the cost of a GFIP policy exceeds the remaining amount of IHP assistance available to the applicant, then FEMA will not purchase a policy. The applicant will still be responsible for purchasing a policy on their own.
- Applicants who own or rent travel trailers on non-permanent foundations are not eligible for GFIP.¹⁷⁷
- Applicants whose pre-disaster primary residence is located within an OPA and SFHA must submit the following documentation in order to receive consideration for a GFIP certificate:
 - A legally valid building permit for the construction of the applicant’s pre-disaster primary residence issued prior to November 16, 1991; or if the building permit was lost or destroyed, a written statement to this effect signed by the community official responsible for the building permits demonstrating the construction of the applicant’s pre-disaster primary residence permitted prior to November 16, 1991.
 - A written statement by a responsible community official that:
 - The applicant’s pre-disaster primary residence was built (walled and roofed) no later than November 16, 1991; and
 - The building was not substantially improved or substantially damaged on or after November 16, 1991.

- Additional forms of documentation to demonstrate a pre-disaster residence's eligibility for NFIP coverage may include:
 - First mortgage financing records;
 - Property tax records;
 - Electrical permit records;
 - On-site septic or sewer system records;
 - State Coastal Zone Management Agency Records;
 - State Wetlands Program Permit Record

VII. Recovery of Program Funds

Federal agencies are required to take action to identify and recover improper payments, whether made in error or obtained by fraud, per the following Federal laws:

- Debt Collection Improvement Act of 1996 (DCIA)
- Improper Payments and Information Act of 2002 (IPIA)
- Improper Payments Elimination and Recovery Act of 2010 (IPERA)
- Improper Payments Elimination and Recovery Improvement Act of 2012 (IPERIA)

In addition, the applicant must agree to return funds to FEMA when the assistance provided by FEMA duplicates assistance from another source,¹⁷⁸ was provided in error, was spent on expenses inappropriately, or was obtained through fraudulent means.

After every disaster, FEMA is required to review disaster assistance payments to ensure taxpayer dollars were properly spent. Those reviews often show a small percentage of specific cases where disaster assistance was given to applicants who were not eligible for some or all the money they received. FEMA collects these overpayments through a process called “recoupment.”

FEMA employs a deliberative process to identify and verify payments that must be recouped and established as debts. This process involves multiple levels of FEMA staff and management review and validation before a debt is established. When FEMA determines assistance was given to applicants who were not eligible for some or all the money received, FEMA IA program staff notifies the applicant in writing of their potential debt and their right to appeal the decision.



Eligibility of Applicant with a FEMA Debt

An applicant who has a FEMA debt from a current or previous disaster may be eligible for IHP assistance in a subsequent disaster, except in cases where the debt is a result of the applicant obtaining assistance through fraudulent means.



Fraud

Fraud is the intentional deception, concealment, or use of documents intended to mislead FEMA in order to wrongfully obtain IHP assistance an applicant is not eligible to receive. FEMA staff are required to report suspected fraud to the Department of Homeland Security (DHS) Office of Inspector General (OIG). The OIG investigates potential fraud cases and, when appropriate, refers them to the Department of Justice (DOJ) for appropriate legal action. FEMA may not establish or collect debts related to fraud unless the OIG or DOJ declines to pursue legal action and instructs FEMA to proceed.



Significant Enforcement Principle

FEMA will consider initiating collection of a potential debt, regardless of debt value, when it is necessary to aggressively pursue recoupment of any assistance obtained through fraudulent means.

After the applicant exhausts their appeal rights or the period to appeal the debt expires, a debt is officially established. The FEMA Finance Center (FFC) will send a letter to the applicant to provide information on repayment options.

FEMA considers expenses associated with the time and resources required to prepare and follow up on a potential debt to determine if the costs of recovering the potential debt will exceed the amount owed. FEMA will not initiate recoupment activity for any potential debt valued less than \$250.00 unless a significant enforcement principle is at stake.

Figure 33: FEMA Process for Identifying and Validating Debt Payments	
Steps	Process
Identifying Potential Debt	FEMA staff review cases to identify potential debts and submit the case for additional review and validation.
Verifying Potential Debt	Each case is assigned to another FEMA staff member who reviews to ensure the decision to request an applicant return funds to FEMA is absolutely necessary. All reasonable efforts are made to identify assistance the applicant was eligible to receive and does not need to be returned. FEMA may contact applicants at this stage to give them an opportunity to provide additional documentation to resolve the issue.
Potential Debt Notification and Appeal	Multiple FEMA managers are required to review each case and concur on the type and amount of assistance that must be returned. FEMA managers also review the case to ensure all appropriate steps to resolve the issue were taken. When FEMA managers determine the assistance must be returned, a written notice is sent to the applicant notifying them of their potential debt, the reason the applicant is not eligible for the assistance provided, and information regarding how they may appeal and/or request an oral hearing.
Appealing a Potential Debt	Applicants may submit a written appeal within 60 days of receiving written notice of their potential debt.
Establishing Debt	If an applicant does not appeal the decision or their appeal is not granted, the debt becomes final and is forwarded to the FFC to continue debt collection activities.
Debt Compromise, Suspension, and Termination	Once a debt has been established, applicants may work with the FFC to make payment arrangements. In limited circumstances, the FFC may suspend or terminate debt collection.
Transfer of Debt to Treasury	If the applicant has not repaid the debt or has not entered into a repayment plan within 120 days of FFC's letter, FEMA refers the debt to Treasury for collection. Significant additional costs will be incurred as a result of referral to Treasury.

A. Reasons for Recovery of Funds

FEMA must recover IHP assistance when there is evidence of:

- Duplication of Benefits (DOB),¹⁷⁹ which occurs when FEMA provides funds that were also previously received or available from another source, such as insurance or another Federal agency. A DOB may also occur when multiple applicants in a household receive an award for the same item or type of assistance.
- Assistance provided in error, which occurs when FEMA determines assistance was provided to the applicant for which they are not eligible.
- Misuse of funds, which occurs when FEMA determines the applicant spent the funds inappropriately (e.g., using assistance to pay off credit card debt).
- Fraud, which occurs when FEMA determines the applicant obtained the assistance through false means (e.g., false address, submitting false or altered documents, misrepresenting insurance coverage).

B. Identifying and Verifying Potential Debts

FEMA must ensure IHP assistance is provided only to eligible applicants, and when it is determined assistance was provided in error or for which the applicant is not otherwise entitled, recoupment actions are mandatory.¹⁸⁰ FEMA identifies potential debts through routine internal reviews, information provided by the applicant, reports from other agencies, audits conducted by the Government Accountability Office, FEMA fraud investigators, or the Department of Homeland Security Office of Inspector General (OIG). When FEMA identifies that funds may need to be returned, at least two FEMA employees perform an initial review of the applicant's case to determine whether an erroneous payment has been made. Each FEMA employee compares the assistance provided to the amount the applicant was eligible for during the review process.

In reviewing for error, FEMA may identify more than one applicant who may be liable for the same potential debt and choose to pursue simultaneous notification and collection against all potentially-liable applicants. When one of the potentially-liable applicants was a minor at the time they applied for assistance, FEMA will pursue collection against a co-applicant or legal guardian. If the sole applicant was a minor at the time they applied for assistance, FEMA will only pursue funds awarded in error in limited circumstances, such as the applicant received assistance through fraud, or was legally emancipated or living outside their household in order to attend an institution for higher education when they received assistance.

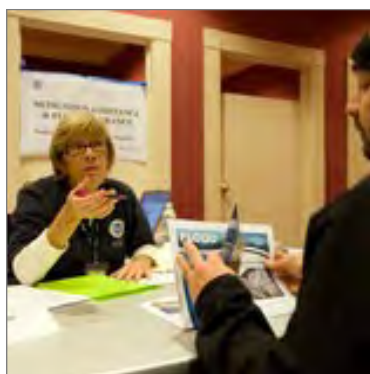

A FEMA staff member explains disaster assistance programs to an applicant at a Disaster Recovery Center (DRC) in Washington.

When the case reviews indicate an error was made, FEMA will, whenever possible, attempt to obtain additional information that may demonstrate that the funds do not need to be repaid by contacting the applicant, contractors, landlords, insurance companies, or other third parties. After the additional information has been obtained, FEMA may determine that the funds were properly awarded and close the review. When the review confirms that an error or improper payment has been made, the case is provided to a senior manager within the IHP program office at FEMA Headquarters for a final review.

FEMA does not initiate debt collection on cases of fraud until they have been investigated by FEMA fraud investigators and/or OIG. FEMA investigators and the Office of Chief Counsel will coordinate on the appropriate debt collection activities.

C. Notice of Potential Debt and Appeal Process

Once FEMA has determined that the applicant was awarded more assistance than they were eligible for, the applicant is sent a Notice of Potential Debt Letter (NPD) identifying all the following:

- The amount of assistance the applicant received for which FEMA has determined the applicant is ineligible
- The reason(s) the applicant is not eligible for the assistance provided
- The process for appealing the decision, including the process for requesting an oral hearing
- The documentation required to dispute the ineligibility determination
- The notice that a final determination will be provided to the applicant informing them whether a debt is owed

Applicants who disagree with the potential debt amount or reason may submit a written appeal or request for an oral hearing within 60 days of the date on the FEMA potential debt notification letter (for more information about appeals, (see [Chapter 3, II.](#)). When an applicant submits an appeal, FEMA will evaluate their case, including any new information submitted, to determine whether the potential debt stands in whole or in part.

1. Oral Hearings

Applicants may request an oral hearing as part of their written appeal. FEMA will only grant oral hearings in limited cases, when there is an issue of identity theft, credibility, or truthfulness, and the case cannot be decided solely on the review of documents. The Alternate Dispute Resolution Division within FEMA's Office of Chief Counsel conducts the hearing. If the Oral Hearing Officer decides not to grant an oral hearing, that decision is final and cannot be appealed.

The Oral Hearing Officer reviews all the information regarding the case before the hearing. If the case was previously investigated for potential fraud, the Oral Hearing Officer's review will include reports and information gathered during the investigation. During oral hearings, applicants are permitted to present information and witness statements to support their claim(s), and FEMA staff represent the Agency's position. If a potential fraud investigation is conducted, a representative from the Fraud Investigation and Prevention Branch will present information about the investigation and report during the oral hearing. Oral hearing decisions are considered final agency determinations that cannot be appealed, and a decision letter drafted by the Oral Hearing Officer is mailed to the applicant.

2. FEMA Appeal Determination

FEMA evaluates an applicant's case and their appeal and makes a final written decision within 90 days after receiving the appeal, or 45 days after concluding the oral hearing.

- Based on a review of the applicant's appeal, FEMA may grant an appeal challenging the reason for the potential debt or the amount of the potential debt.
 - When FEMA grants an appeal for the reason for the potential debt, FEMA will terminate the debt and return any money the applicant paid to FEMA.
 - When FEMA grants an appeal for any amount of the potential debt, FEMA will adjust the amount of the debt based on the appeal decision when:
 - An applicant already paid the debt. FEMA will return any money to the applicant that was in excess of the final debt amount based on the appeal.
 - The final debt amount based on the appeal was more than the amount the applicant already paid. FEMA will continue to collect any remaining portion of the reduced debt.
 - The applicant has not made any payments to FEMA for the debt. FEMA will continue debt collection activities.
- Based on a review of the applicant's appeal, FEMA may deny an appeal challenging the reason or amount for the potential debt. If FEMA denies the appeal, FEMA's decision is considered a final agency determination and may not be appealed again.

FEMA establishes the debt amount after the appeal period expires and all decisions are rendered on any appeals received, and forwards the debt to the FFC for continued debt collection activities.

As part of the debt collection activities, the FFC will provide each applicant the opportunity to make payment arrangements.

D. Debt Compromise, Suspension, or Termination

Once the appellate process is complete and a debt has been established, the FEMA Finance Center (FFC) sends a written "Notice and Debt Letter" (NDL) to applicants to inform them that the debt has become final, that interest and penalties that will start to accrue on the debt if it is not paid, and of their rights to request payment arrangements, compromise, and request a debt waiver. FFC considers an applicant's request to compromise, suspend, or waive a debt.

1. Payment Arrangements and Compromise

When an applicant requests a payment plan or compromise, FFC may request financial information in order to determine whether the applicant has the ability to pay the debt in one lump sum or in monthly payments. If the FFC determines that the applicant does not have the ability to pay the entire debt, it may agree to a compromise by accepting less than the full amount owed to satisfy the debt. If the applicant's financial situation does not warrant a compromise of the debt or is otherwise not qualified due to a substantiated finding of fraud, the FFC will notify the applicant.



Compromise

Compromise means an agreement to accept less than the full amount owed to satisfy the debt.

2. Debt Waiver

If the debtor does not qualify for a full compromise and the debt results from a major disaster or emergency declared on or after October 28, 2012, the FFC may – upon written request from the debtor – waive a debt, in whole or part, where the erroneous payment was based on FEMA error, there is no debtor fault, and the collection of the debt would be against equity and good conscience. Debt waivers are discretionary and will not be granted retroactively. The applicant has the burden of demonstrating that a waiver is appropriate.

3. Debt Suspension

FEMA may suspend debt collection activities at any time during the collection process for various reasons, to include: when the debt is uncollectible due to the applicant's current financial inability to pay but the applicant has the future potential to reinstate payments.

4. Debt Termination

FEMA may terminate debt collection efforts in accordance with the criteria established in the Federal Claim Collection Standards where such collection is not economically worthwhile or collection is otherwise inappropriate, including when:

- FEMA is unable to collect any substantial amount through its own efforts or through the efforts of others.
- FEMA is unable to locate the debtor.
- The debt is legally without merit or enforcement of the debt is barred by any applicable statute of limitations.
- The debt has been successfully discharged in bankruptcy.
- Costs of collection are anticipated to exceed the amount recoverable.
- The applicant is deceased; no assets remain in the estate sufficient to cover some portion of the established debt, and no co-applicant or co-debtor exists.
- A debt is returned by Treasury to FEMA as uncollectable.

E. Transfer of Debt to Treasury

The FFC refers the unpaid debt to Treasury for collection if a debt is not paid in full, the debt is not being paid on schedule when there is an established payment plan, or the debt was not compromised, suspended, or terminated. Delinquent debts may be referred to Treasury as early as 61 days after FFC notifies the applicant of delinquency, but no later than 120 days after FFC notifies the applicant. In addition, documents which substantiate the debt are provided to Treasury at the time of referral. When the debt is referred to Treasury, interest and penalties continue to accrue on the unpaid debt, and Treasury may add substantial additional fees and administrative charges to the debt. Once a debt has been referred to Treasury for collection, FEMA will not recall the debt unless the applicant is able to prove the notices were sent to an outdated address.

During the debt collection process, Treasury will offset any eligible Federal payments by the debt amount. Treasury is not required to notify the debtor prior to the offset. Federal payments eligible for offset include: income tax refunds; Federal/state salary pay, including military pay; Federal/state retirement, including military retirement pay; contractor vendor payments; and certain Federal benefit payments.¹⁸¹

Treasury provides FEMA all applicant requests for disputes, Proof of Debt (POD), and/or Administrative Wage Garnishment (AWG) hearings. FEMA works with Treasury and processes every hearing request in which new information is provided or a new issue is raised that was not previously addressed in a hearing. When Treasury submits an AWG hearing to FEMA, any debt related to the case is administratively suspended while awaiting the decision (i.e., collections cease); however, during POD and dispute reviews, the debts are not suspended and collections continue unless the FFC specifically recalls the debt.

F. Statute of Limitations

Starting October 2018, FEMA must notify applicants of any potential debt owed within three years of the date the assistance was received for debts arising from major disasters or emergencies declared on or after October 28, 2012. However, if civil or criminal fraud is suspected, FEMA will initiate actions to recover assistance, regardless of the time that has passed between the award and debt notification.

Chapter 4: Disaster Case Managementⁱⁱ

I. Overview

Disaster case management (DCM) is a time-limited process that involves a partnership between a disaster case manager and a disaster survivor (also known as a “client”) to develop and carry out an individual disaster recovery plan. This partnership provides the client with a single point of contact to facilitate access to a broad range of available resources. The goal of the DCM program is to assist individuals and families through the recovery process with finding resources to meet their disaster caused unmet needs.



Disaster Caused Unmet Need

Any un-resourced item, support, or assistance that has been assessed and verified as necessary for a survivor to recover from disaster. This may include food, clothing, shelter, first aid, emotional and spiritual care, household items, temporary housing, home repair, or rebuilding.

FEMA may provide DCM services or financial assistance to SLTT government agencies, or qualified private organizations (collectively, non-Federal entities), to identify and address disaster caused unmet needs following a major disaster declaration.¹⁸²

FEMA’s DCM is intended to augment, not to replace, existing case management capabilities in the impacted area. Following a major disaster declaration, the non-Federal entity must submit an application to FEMA for review and be approved for Federal assistance. There is no non-Federal cost share.

A. Overview of Services to Survivors

Services are provided at no cost and are available to any survivor that has been impacted by the disaster, regardless of eligibility for FEMA IHP or other Federal assistance. DCM must be accessible to people regardless of race, color, national origin, sex, age, disability, English proficiency, or economic status. In particular, providers of DCM must plan to meet the needs of people with limited English proficiency and people with disabilities, such as people who are deaf or hard of hearing who may use sign language or captioning.

The DCM process is described in *Figure 34*.



Qualified Private Organization

A qualified private organization is defined as any non-governmental organization or entity that currently has an effective ruling letter from the U.S. Internal Revenue Service, granting tax exemption under Sections 501(c) of Internal Revenue Code of 1954, or satisfactory evidence from the state, territorial, or tribal government that the nonrevenue producing organization or entity is a nonprofit one organized or doing business under state, territorial, or tribal government law and that has experience providing case management services.

ⁱⁱ OMB revised the regulations that govern federal grants and cooperative agreements, please refer to Title 2 of the Code of Federal Regulations for more details. See [Electronic Code of Federal Regulations](#).

Figure 34: DCM Process

Service	Definition
Define Eligible Clients	Individuals and families whose primary residence or place of employment was in the impacted area and have a verifiable disaster-caused unmet need that has not been met through other assistance. Clients do not have to be registered with FEMA to receive Federal Disaster Case Management assistance.
Client Outreach	In coordination with the Joint Field Office (JFO), other Federal partners, non-Federal entities, local and community leaders, providers will perform outreach to connect with clients who could benefit from Federal Disaster Case Management services.
Triage Needs	The primary purpose of triage is to assign a priority level to a case based on the client’s severity of need and ability to recover. It requires regular reassessment, particularly as the client transitions into long-term disaster case management.
Screen and Assess	After clients are identified through outreach and triaged, the disaster case manager will conduct a screening, gathering necessary information such as pre- and post-disaster contact information, the number of impacted individuals in the household, whether the client rented or owned their pre-disaster residence, and copies of documents needed to verify clients residence or employment in the declared area. Case managers may also use available FEMA registrant data to inform this step and avoid asking survivors for duplicate information.
Information and Referral (I&R)	Based on clients’ identified needs, the disaster case manager will provide information and referral to short term, immediate available resources and work with the survivor to develop an individually tailored disaster recovery plan that includes next steps and goals. A survivor may not require full DCM services, but may have immediate needs that can be resolved through I&R.
Development of Recovery Plan	The disaster case manager and the client will develop a preliminary recovery plan based on the client’s identified unmet needs. The plan may be revised as necessary. During the assessment process, the disaster case manager seeks to establish a baseline of pre-disaster functioning.
Advocacy and Referral	Both the disaster case manager and the client are responsible for advocating for the services needed to move toward recovery. The disaster case manager will provide referrals to available resources to help meet the client’s needs.
Monitor Recovery Plan	A disaster case manager will monitor a client’s progress toward achieving goals defined in their disaster recovery plan by providing regular client contact and case file reviews that may result in adjustments to the client’s disaster plan.

B. Program Types

FEMA's DCM is comprised of two programs, Immediate Disaster Case Management (IDCM) and the Disaster Case Management (DCM) program. IDCM is not a prerequisite for DCM, nor is DCM required if IDCM has been approved. Both programs require the event to be a Presidentially-declared disaster.

1. Immediate Disaster Case Management

IDCM provides short-term, limited services to address immediate disaster caused unmet needs and make referrals for disaster survivors. IDCM may have a period of performance not to exceed 180 days, at which time cases will be transferred to the longer-term DCM program to local social service organizations. Under extraordinary circumstances, extensions may be considered. The size of the impacted population and the scope of the disaster, as well as the ability of local resources to adequately meet the immediate disaster-caused unmet needs of survivors, may be factors in determining whether or not IDCM is required.

2. Disaster Case Management Program

The DCM program is a FEMA-funded supplemental program that generally provides financial assistance to SLTT government agencies, or qualified private organizations, through a Federal award. This program may be implemented through a grant or a cooperative agreement. FEMA shall make the determination of which funding instrument to use in administering the award. Typically, a grant agreement is used when no substantive involvement by FEMA is anticipated. If substantial FEMA involvement is anticipated, a cooperative agreement may be utilized. The DCM Federal award, when approved, enables non-Federal entities to provide services or contract with local providers familiar with disaster case management and the impacted communities.

C. Waivers to Existing Program Policy

Any waivers to this policy guidance must be submitted in writing, with justification, to the FEMA IA Division Director (IADD) for consideration and a determination.

D. Authorities

FEMA is authorized to provide case management services, including financial assistance, to SLTT governments or qualified private organizations to provide such services to survivors of major disasters to identify and address disaster caused unmet needs under Section 426 of the Stafford Act.

Regulations within the Uniform Administrative Requirements, Cost Principles, and Audit Requirements for Federal Awards found in 2 C.F.R. Part 200 are applicable to all DCM Federal awards implemented as grants or cooperative agreements.

II. Immediate Disaster Case Management

IDCM provides short-term, limited services to address immediate disaster caused unmet needs and make referrals for disaster survivors. IDCM may have a period of performance of 90-180 days, at which time cases will be transferred to the longer-term DCM program to local social service organizations. The size of the impacted population and the scope of the disaster, as well as the ability of local resources to adequately meet the immediate disaster-caused unmet needs of survivors, may be factors in determining whether or not to request IDCM services. IDCM is not a prerequisite of the DCM program. An SLTT government or qualified non-Federal entity may apply for DCM even if no IDCM is implemented. IDCM staff provide the same case management services as the DCM Federal award, but are generally focused on the early steps in the DCM process – outreach, triage, information and referral, and development of an individual recovery plan. The goal of IDCM is to address the immediate unmet needs of disaster survivors and prepare their cases to be transferred to long-term case management services if additional support is needed.

IDCM funding is not awarded to the SLTT; it is directly implemented, administered, and overseen by FEMA, in coordination with the STT government. IDCM may be implemented through:

- a mission assignment to other Federal agencies to provide case management services
- invitational travel to support travel for voluntary agency personnel experienced in case management
- an interagency agreement with national-level partners experienced in case management
- direct hiring of case managers to work with FEMA personnel
- an existing FEMA contract with an experienced case management entity

FEMA will assess the alternatives, in coordination with the impacted STT government and determine the best approach to implementing IDCM based on the needs of the impacted community.

A. IDCM Period of Assistance

Implementation of IDCM typically begins within 14-30 days of the declaration date. The period of assistance for IDCM will not exceed 180 days. In extraordinary circumstances, such as catastrophic events, the program may be extended by the Federal Coordinating Officer (FCO).

B. Transition to Non-Federal Entity DCM Federal Award Program

At the conclusion of IDCM, cases will be transitioned either to a DCM program or, if the non-Federal entity elects not to apply for a DCM Federal award or is not approved, to local providers (i.e., SLTT government agencies, nonprofits). Planning for the transition, particularly of survivor data should begin early to ensure smooth and efficient transition of information and to streamline the access to services for survivors.

Transition from IDCM will require collaboration between the non-Federal entity, FEMA, and IDCM program or technical staff to identify the most effective approach to transfer files, including a process both for information sharing and the actual transfer of cases. The timing of actual transition may be fluid due to the non-Federal entity DCM program Federal award application and award process.

The transition plan must include an ability to securely transfer hard copy and electronic case files to the DCM program or local service providers, as directed by the non-Federal entity. Service providers shall not disclose applicant contact information to other parties outside of FEMA in accordance with the [Privacy Act of 1974](#).

C. Congressional Notification Process

Department of Homeland Security Appropriations Act, Sec. 507, requires FEMA to notify the Congressional Appropriations Committee at least three full business days in advance of making or awarding a grant allocation, grant, contract, or other transaction agreement exceeding \$1,000,000. This process may add weeks to the timeline before obligating the Federal award.

III. Disaster Case Management Program

The DCM program is a FEMA-funded supplemental program that provides financial assistance to SLTT government agencies, or qualified private organizations, through a Federal award. This program may be implemented through a grant or a cooperative agreement. The DCM Federal award, when approved, enables non-Federal entities (also known in this context as recipients) to provide services or contract with local providers familiar with disaster case management and the impacted communities.

A. Period of Assistance

DCM Federal awards may be awarded for a period of performance up to 24 months from the date of declaration. If necessitated and justified, the recipient may submit a request in writing to the appropriate FEMA Regional Administrator (RA) for a 90-day extension to the period of performance. These written requests must be submitted no later than 90 days prior to the end of the period of performance. Extension requests will be evaluated based on the progress made during the initial period of performance and the justification of ongoing need.



DCM Federal Award Toolkit

FEMA has developed an online toolkit containing required documents and tools to complement this guidance and assist stakeholders in preparing, assessing, applying, implementing, managing, and closing a DCM Federal award program. FEMA updates the toolkit regularly to incorporate best practices and lessons learned, thus, non-Federal entities should refer to the most current documents in the [DCM Toolkit](#) prior to applying for a Federal award.

In some instances, due to the exigency of the need in the impacted area and in order to expedite award of the funding, the non-Federal entity may apply for and FEMA may approve an initial award with a shorter period of performance, less than 24 months. In these instances, the recipient will have the option to request, in writing, an extension to the period of performance up to the full 24-month period of performance. Extension requests will be evaluated based on the progress made during the initial period of performance and the justification of ongoing need.

B. General Conditions of Eligibility for a DCM Federal award

All the following conditions must be met for a non-Federal entity to be considered by FEMA for a DCM Federal award:

- The President must declare a major disaster.
- The need for disaster case management services must be beyond the capabilities of the SLTT government to provide due to the severity and magnitude of the disaster.
- The non-Federal entity must submit a complete DCM Federal award package (see Chapter 4, III.D.) within 90 days of the date of declaration of the Presidentially-declared major disaster.
- The DCM Federal award packet must be signed by the Governor or Governor's Authorized Representative (GAR); the Tribal Chief Executive or Tribal Chief Executive Authorized Representative (TAR); or the non-Federal entity must be authorized to directly receive the award in the FEMA-State/Territory/Tribe Agreement.

C. DCM Award Roles and Responsibilities

1. FEMA

As the Federal awarding agency, FEMA’s primary responsibility is to ensure the DCM program is implemented in accordance with this guidance, the Federal award articles of agreement, the requirements of the financial award as noted in the NOA, and 2 C.F.R. Part 200. FEMA provides quality assurance and monitors the non-Federal entity in meeting Federal award requirements, use of the Federal award funding, and meeting the audit requirements of the program. FEMA will maintain a toolkit accessible by the non-Federal entity; this toolkit will include application information, forms, templates, and job aids for preparation, application, and implementation of the program. FEMA will also provide two Federal officers to support the non-Federal entity in overseeing the Federal award, the Grants Management Officer (GMO) and the Program Officer (PO).

The GMO is primarily responsible for receiving and acting on requests for prior approval or for changes in the terms and conditions of the award as well as for monitoring the drawdown of funding to ensure it is consistent with allowable and unallowable cost. The GMO is the primary point of contact for receiving and processing non-Federal entity requests for changes to the terms and conditions of the award. The PO provides regular technical assistance and programmatic coordination with the non-Federal entity.

Figure 35 details the GMO and PO responsibilities associated with the Federal award.

Figure 35: Fiscal and Program Officer Responsibilities	
Grants Management Officer	Program Officer
<ul style="list-style-type: none"> Evaluating Federal award applications for administrative content and compliance with statutes, regulations, and guidelines. Making site visits to monitor the progress of the Federal award. 	
<ul style="list-style-type: none"> Negotiating awards. Providing consultation and technical assistance to applicants and recipients, including interpretation of grants administration policies and provisions. Administering and closing out Federal awards. 	<ul style="list-style-type: none"> Providing programmatic technical assistance. Determine the frequency of conference calls, site visits, and programmatic performance reports within Federal guidelines. Monitoring performance of the program, including reviewing progress reports.

2. Non-Federal Entity

The non-Federal entity is responsible for assessing the DCM needs, applying, and overseeing the DCM award in accordance with all applicable Federal award requirements, state regulations, and this guidance. In addition, they are responsible for:

- Formulating the program, budget, and project design in a manner that meets minimum [reporting and monitoring requirements](#), as well as the Federal award agreement;
- Maintaining clear control of program operations and ensure response to emergent issues in a timely manner;
- Reporting aggregate data on program activities to FEMA, and with FEMA's prior approval, to determine how personally identifiable information (PII) will be shared with service providers following The Privacy Act of 1974, 5 U.S.C. § 552a;
- Standardizing services among DCM service providers with overall quality assurance, including budget requirements, staffing, program planning, reporting, training, and technology for tracking and resource sharing; and
- Developing a plan that outlines their collaborative process with SLTT voluntary organizations, including, if applicable Voluntary Organizations Active in Disasters (VOAD), as well as the Emergency Management agency, and Long-Term Recovery Groups.

D. Pre-Award Requirements for DCM

1. DCM Needs Assessment

The DCM needs assessment is the responsibility of the non-Federal entity and should be submitted with the DCM Federal award application. The assessment evaluates the current capacity to provide disaster case management services and identifies the specific populations that will be served by the supplemental program. A capacity survey to support the non-Federal entity in this step is available in the [DCM toolkit](#). Information from this survey and any additional information regarding needs of the impacted community should be included in the overall justification when applying for DCM.

2. DCM Award Application

After a Presidential disaster declaration, a non-Federal entity may apply for a DCM Federal award. The DCM application package must be submitted to FEMA no later than 90 days after the IA declaration. In extraordinary circumstances, such as catastrophic events, the non-Federal entity may apply for an extension to this deadline in writing to the applicable FEMA RA; this request must document the extraordinary circumstances and what the additional time will allow them to accomplish. The non-Federal entity must submit this request within 60 days of disaster declaration. Extension requests not submitted within this timeframe will not be considered.



Tailoring the Program to the Population

When assessing the needs of the affected population, it is important to consider the proportion and effect on older adults, people with disabilities and others with access and functional needs, children, people with lower incomes, and people with limited English proficiency. The program may be tailored to meet the needs of the specific community. For instance, if a high proportion of children were impacted, adding a children's coordinator in your staffing plan may be beneficial.

Shortened DCM Awards

The non-Federal entity may apply for, and FEMA may approve, an initial award with a shorter period of performance less than 24 months. This shortened application may be submitted at any point prior to the DCM deadline. If approved, the non-Federal entity may request an extension up to the total 24 months consistent with extension requirements.

Application Process and Delegation of Authority

DCM Federal awards are generally applied for by an STT government agency. However, the STT government may request that FEMA provide an opportunity for a local government agency or qualified private organization to apply for a Federal award. This request should be made in writing, accompanied by an assessment justifying the need for a DCM program, signed by the Governor or GAR or Tribal Chief Executive or TAR, and submitted with the application. FEMA will review the documentation and make a determination on the best alternative to address the needs.

Cover letters for the DCM Federal award application packet should be addressed to the applicable FEMA RA. Applications for DCM will be reviewed and approved or denied by the FEMA RAs. Note that the Disaster Recovery Manager (DRM) authority does not carry the delegation of the DCM determination (delegation of authority is separate from the delegation of DRM authority).

Approval or Denial of Application

The RA may approve or deny the Disaster Case Management program award. The program may be approved if:

- A complete application is received no later than 90 days from the date of declaration; and
- There is a need for the program clearly articulated in the application.

If approved, the RA will send a signed approval memo with reason for approving to the FCO and Regional Grants Management Division (GMD) Director for processing of the Federal financial award, as a grant or cooperative agreement. The RA or their designee will issue the Notice of Award to the non-Federal entity receiving the award.

The program may be denied if:

- A complete application is not received within 90 days from the date of declaration; or
- The application lacks sufficient information to justify the need for the program.

If denied, the RA must submit a written denial with justification to the non-Federal entity.

Required Information

A complete DCM Federal award application must include the information found in *Figure 36* and documentation to be considered for an award:

Figure 36 : DCM Application Required Information and Documents	
Information	<ul style="list-style-type: none"> • The geographical areas within the designated disaster area for which services will be provided; • An estimate of the number of disaster survivors requiring assistance; • A description of the SLTT resources and capabilities, and an explanation of why these resources cannot meet the need; • A description of activities from the date of the disaster incident to the date of application; • A plan of services to be provided to meet the identified needs; and • A detailed budget, showing the cost of proposed services separately from the cost of reimbursement for any eligible services provided prior to the application.
<u>Request for Federal Assistance (SF-424)</u>	A Federal form that OMB requires for Federal award applications. All entities that apply for DCM funds must submit a completed SF-424 signed by the Governor or GAR, or Tribal Chief Executive or TAR.
<u>Budget Information for Non-Construction Programs (SF-424A)</u>	A Federal form OMB required for Federal award applications.
<u>Assurances for Non-Construction Programs (SF-424B)</u>	A Governor, GAR, Tribal Chief Executive, or TAR signature is required.
Budget Narrative	The budget narrative should include a detailed justification for all cost categories requested in the SF-424A. Refer to the <u>DCM toolkit</u> for additional instructions on completing the Budget Narrative.
Lobbying Forms	SF-LLL and the Grants.gov Lobbying Certification Form must be on file with FEMA. The STT government must acknowledge that the forms are in compliance with the FEMA-State/Territory/Tribe Agreement and the most current <u>Department of Homeland Security (DHS) Standard Terms and Conditions</u> .

3. Budget

The DCM budget narrative must justify the proposed budget for the non-Federal entity, subrecipients of a Federal award, and each individual service provider. The narrative must provide a justification of the costs and an itemization for each line of the budget. When filling out the DCM award application, applicants must adhere to the following budget limitations:

Allowable Costs

- **Pre-Award Costs**—Pre-award costs are those which are incurred prior to the start date of the period of performance (2 C.F.R. § 200.209). The period of performance for an approved DCM Federal award typically starts on the date of the disaster declaration. Costs accrued prior to the disaster declaration are not allowable. If exigent circumstances occur and the period of performance starts later than the declaration date and prior to the notice of award, such costs may be allowable only to the extent that they would have been allowable if incurred after the date of the Federal award and only with written approval of the FEMA Regional Administrator.¹⁸³
- **Salaries and Wages:** Salary compensation must be reasonable in amount and in alignment with local prevailing rates for the position funded.
- **Fringe Benefits:** Fringe benefits may be charged directly to the Federal award. Claimed costs must be reasonable and conform to established policies for the STT government. Use of a pre-established provisional rate requires allocation to total salary costs. Rates must be adjusted to actuals at the year-end and rates should be reviewed at least once annually.
- **Equipment:** The non-Federal entity obtains title to equipment acquired under the DCM award and is subject to the conditions outlined in 2 C.F.R. § 200.313, including these requirements:
 - To use the equipment for the authorized purposes of the project until funding for the project ceases, or until the property is no longer needed for the purposes of the project;
 - To not encumber the property without approval of FEMA;
 - To use and dispose of the property in accordance with guidelines for states and non-states as set forth in 2 C.F.R. § 200.313; and
 - To use in a manner consistent with the purposes of the award and to benefit the beneficiaries of the project.

- **Supplies:** FEMA retains an interest in any unused supplies exceeding \$5,000 in total aggregate value upon termination or completion of the award if they are not needed for any other Federal award. The STT government must compensate FEMA for its share of the supplies in compliance with 2 C.F.R. § 200.314. As long as FEMA retains an interest in supplies, the STT government must not use the supplies to provide services to other organizations for a fee that is less than private companies charge for equivalent services.
- **Travel:** Travel must be included in the budget for preapproval as part of the application process. During implementation, travel costs must be supported by travel expense reports detailing employee name, the reason for the trip, and itemized expenses claimed. Claimed costs should be charged according to the award recipient's travel policy, which requires prior approval from FEMA and must comply with OMB cost principles and provide expenditure limitations. Major items of expense (e.g., airfare, lodging) must be supported by receipts.
- **Other:** The budget may identify costs that are unique to the disaster and area impacted but do not fall into one of the prescribed cost categories listed above. Costs must be supported by adequate documentation (invoices, receipts, etc.). Consult with the FEMA Grants and Program Officer to determine which costs are allowable under this cost category and to confirm what items may require prior approval.
- **Contractual Costs:** The non-Federal entity must follow the applicable Federal procurement requirements at 2 C.F.R. § 200.317 through § 200.326. Per 2 C.F.R. § 200.317, STT governments must follow the same policies and procedures they normally use, as well as comply with the requirements for procurement of recovered materials (§ 200.322) and including required contract provisions (§ 200.326). For all other non-Federal entities, they must follow all the requirements at 2 C.F.R. § 200.318 through §200.326. As part of these requirements, non-STT government entities must use their own documented procurement procedures that reflect applicable STT government laws and regulations provided that the procurements comply with Federal law and procurement regulations.

Unallowable Costs

- **Indirect Costs—Unallowable:** FEMA does not authorize the use of funds for indirect costs. Indirect costs, including management costs, are defined as costs not directly chargeable to a specific project. Please note that even if an indirect cost rate is established, it is subject to statutory and administrative limitations. A DCM award recipient or provider is not entitled to an established rate for services provided under the DCM award. The program's statutes, regulations, and policy govern whether any indirect costs are eligible. Section 324 of the Stafford Act requires FEMA to establish management cost rates through regulations. At this time, FEMA does not have regulations that govern the eligibility of indirect costs for the DCM.

Please refer to [Appendix E](#) for more information on allowable and unallowable costs.

4. Federal and Congressional Review Process

Once submitted, the non-Federal entity's DCM application will go through a review by FEMA Joint Field Office (JFO), FEMA Region, and FEMA HQ staff for completeness, cost-effectiveness, and feasibility of the non-Federal entity's DCM application. FEMA will respond to the non-federal entity with an application determination or a request for additional/clarifying information within 60 days of receipt of packet. The FEMA RA will issue a determination.

Under the Department of Homeland Security Appropriations Act, Sec. 507, FEMA is required to provide 72 hours advance Congressional notification when awarding a grant or contract in excess of \$1,000,000. Notification is routed to the Congressional Appropriations Committee for advanced notification review, after review and clearance by DHS and OMB. This process may add multiple weeks to the timeline before FEMA may issue the Notice of the Federal award to the non-Federal entity.

E. Notice of Award (NOA)

The NOA is the official Federal award document notifying the recipient and others that an award has been made. The NOA contains all terms and conditions of the Federal award and provides the support documentation for recording the obligation of Federal funds in the non-Federal entity's accounting system.

Critical information included in the NOA:

- The start and end dates for the period of performance
- The award amount
- Name of FEMA grants officer
- Name of FEMA program officer
- Reporting requirements

FEMA will schedule a post-award call with the non-Federal entity to review the NOA, Conditions of Award, program expectations, reporting requirements, the funding process, and the monitoring schedule.

1. Conditions of Award

FEMA's Regional Grants Management Division will generate an NOA letter that details all conditions the non-Federal entity must satisfy within the timeframe designated in the letter.

The non-Federal entity is responsible for the accounting and expenditures, cash management, maintenance of financial records, and refunding expenditures disallowed by audits. The non-Federal entity must establish a Payment Management System (PMS) account prior to allocation and obligation of funds to transfer funds from FEMA to the non-Federal entity.

Additional information on the funding process is available in the DCM Toolkit.

F. Post-Award Requirements for DCM

1. Multiple DCM Programs within the Geographic Area

Multiple DCM Programs

Occasionally, multiple DCM programs are awarded for the same area that is affected by overlapping Presidentially-declared disasters. If multiple DCM programs are operating concurrently, the non-Federal entity must ensure there is a mechanism in place to identify and mitigate the risk of duplication of services for clients impacted by the multiple disasters. The non-Federal entity must develop internal controls and provide its strategy for operating multiple programs for the same affected population and identifying the programmatic, financial, and management components of each program.¹⁸⁴ This strategy must be included as part of the application. Budget and programmatic reporting must remain distinct and separate between programs and highlight the number of cases transferred between disasters.

A client will have one open case at a time. If a client has identified needs from multiple disasters, and there are multiple DCM programs operational concurrently, the state must outline the process for coordination between DCM programs to ensure that services provided are disaster-specific and not duplicated for clients impacted by multiple disasters.

2. Procurement Requirements under a Federal Award

Federal award recipients shall ensure that the process of soliciting DCM services is fair and transparent. Recipients must follow the same policies and procedures when procuring property and services under a Federal award that they follow for procurement from non-Federal funds. Recipients must ensure that any contract provisions as required by 2 C.F.R. § 200.326 Contract Provisions are included on all purchase orders or contracts that draw from Federal funds, and states must follow the state procurement requirements as described in 2 C.F.R. § 200.317. All other recipients, including subrecipients of an STT government will follow the General procurement standards as required by 2 C.F.R. § 200.318 through § 200.326.

3. Appeals and Modifications to Award

Appeal for Denied Federal Award Application or Extension

The non-Federal entity may appeal the FEMA RA's decision. This appeal must be submitted to the IA Division Director (IADD), in writing, within 60 days of the date of the application decision.¹⁸⁵ The appeal must include new justifying information not included in the original Federal award application, including a new budget and associated training and implementation plans if applicable.¹⁸⁶ See the DCM Toolkit for additional information.

Appeals of Remedies for Noncompliance

The non-Federal entity may submit a written appeal letter with supporting documentation, signed by the Governor or GAR, Tribal Chief Executive or TAR, or applicable authorized representative of the non-Federal entity to the appropriate FEMA RA within 15 days of the date of notification of the remedial action. The FEMA RA will make an appeal determination in writing to the applicant.

Objections/Appeals of Decisions Regarding Allowable Costs

The non-Federal entity may submit a written appeal letter with supporting documentation, signed by the Governor or GAR, Tribal Chief Executive, or applicable authorized representative of the non-Federal entity to the FEMA RA within 15 days of the date of notification of the disallowed cost. The FEMA RA will make an appeal determination, in writing to the applicant.

Appeal of Termination or Suspension

In order to appeal termination, the non-Federal entity must include a letter acknowledging receipt of notice of termination as well as a termination appeal letter, unless otherwise specified. If the non-Federal entity decides to terminate their approved DCM prior to the end of the period of performance or withdraw their submitted DCM application, then a signed letter should be sent to the FEMA RA indicating the desire to withdraw the application or terminate the program. The official notification must be signed by the Governor or GAR, Tribal Chief Executive or TAR, or applicable authorized representative of the non-Federal entity. The termination or withdrawal will become effective on the date of the official acknowledgement from FEMA and will not be subject to an appeal should the non-Federal entity choose to reverse the decision.¹⁸⁷

All closeout and reconciliation documents must be submitted in accordance with the timeframes indicated in the DCM Toolkit unless otherwise specified.

Award Modifications or Extensions

- If initial award was for less than the full 24-month Period of Performance (POP):
 - If awarded funding for a period of performance less than 24 months from the date of declaration, the non-Federal entity may request, in writing, an extension to the period of performance up to the full 24-month period of performance.
 - An extension request must be submitted in writing no later than 90 days prior to the end of the current POP.
 - An extension request must include the progress made during the initial period of performance and a justification of ongoing need.
 - The official written request must be submitted to the FEMA RA for determination.
- If the initial award is for the maximum 24-month POP:
 - The POP for DCM is a maximum of 24 months from the date of the major declaration. However, a request for an additional 90-day extension to the POP may be considered when requested in writing with adequate justification to the FEMA RA.
 - A program extension request must be submitted in writing at least 90 days prior to the end of the current POP.
 - All financial and programmatic reports must be current and complete at the time of request or the request will not be processed.
 - The official written request must be submitted to the FEMA RA for determination.

- Supplemental Funding
 - A request for supplemental funding may be considered under extenuating circumstances when sufficient justification is submitted.
 - Written requests for supplemental funding may be requested at least 90 days before the end of the period of performance.
 - Financial and performance status reports must be current and complete.
 - The decision to approve/deny the supplemental funding request will be made by the FEMA RA.



Requests for Supplemental Funding Must Include:

- An explanation of why current funding is insufficient.
- An updated DCM work plan.
- All pertinent statistical information regarding current cases.

4. Monitoring and Reporting

Monitoring

- **FEMA monitoring responsibilities:** FEMA must ensure that the Federal award recipient adheres to all laws, regulations, and policy guidance in all aspects of the DCM program. To do this, they will monitor the non-Federal entity operations and activity. This is done through regularly scheduled monitoring calls, reviewing and analyzing non-Federal entity reporting, and on-site visits. A minimum of three on-site visits is required for each DCM award, more if required in the Conditions of Award if the size, complexity, or scope of the award poses elevated risks. Additional on-site visits, as well as the frequency of the monitoring calls, will be determined by FEMA based on the program needs and may be added during the POP if a need is identified.
- **Non-Federal entity monitoring responsibilities:** The non-Federal entity is responsible for oversight of the entire operations and all supported activities pertaining to the Federal award. As a recipient of a Federal award, the non-Federal entity is responsible for being compliant with all applicable provisions under 2 C.F.R. Part 200, refer to *Figure 37* for some key provisions of 2 C.F.R. Part 200. They must monitor the activities under the awards to ensure compliance with applicable Federal requirements and to ensure performance expectations are being achieved. Monitoring by the non-Federal entity must cover each program, function, and activity.

Reporting Requirements

The non-Federal entity must submit performance reports at the interval required by the Federal awarding agency or pass-through entity to inform status of achieving program outcomes and ensuring compliance with laws, regulations, and policies applicable to the program. Intervals must be no less frequent than annually nor more frequent than quarterly except in unusual circumstances, e.g., where more frequent reporting is necessary for the effective monitoring of the Federal award or could significantly affect program outcomes.¹⁸⁸ Annual reports must be submitted 90 calendar days after the reporting period; quarterly or semiannual reports must be submitted 30 calendar days after the reporting period. Alternatively, the Federal awarding agency or pass-through entity may require annual reports before the anniversary dates of multiple year Federal awards.

Programmatic Reports

Monthly programmatic reports are required. Reports should be submitted to the FEMA Project Officer, and should include the following data, as well as anything else requested by FEMA:

- Number of cases opened
 - Include how many cases are at each tier/priority level
- Number of cases with completed needs assessments
- Number of cases with developed recovery plans
- Number of cases closed
 - Number of cases closed without a completed recovery plan (resource unavailable)
 - Number of cases closed after completing the recovery plan (needs met)
 - Number of cases withdrawn by survivor
 - Other
- Number of survivors on a waitlist for services
- Top 3-5 identified unmet needs

Reported numbers should include a monthly total and a cumulative total for the program. Refer to the DCM Toolkit for templates and additional instructions for assistance.

Financial Reports

The non-Federal entity submits the Federal Financial Report (SF-425) to the FEMA Grants Management Officer within 30 days of the end of each reporting period.¹⁸⁹ The non-Federal entity submits the SF-425 for every quarter of the period of performance, including partial calendar quarters during the life cycle, regardless of the level of activity in that quarter. This requirement continues until the end of the period of performance.

Reporting periods are as follows:

- Quarter 1: October 1-December 31; Due January 30
- Quarter 2: January 1-March 31; Due April 30
- Quarter 3: April 1-June 30; Due July 30
- Quarter 4: July 1-September 30; Due October 30

Budget and Fiscal Management

The non-Federal entity is responsible for accounting, including expenditures, cash management, maintenance of adequate financial records, and the refund of expenditures disallowed by audits. The non-Federal entity and DCM providers must comply with Federal Regulations at 2 C.F.R. Part 200.

A non-Federal entity can only charge allowable costs incurred during the POP. Any costs incurred after the POP, including during the 90-day closeout timeframe for submitting all financial and performance reports, are not allowable.¹⁹⁰

Figure 37: 2 C.F.R. Part 200 Compliance	
Item	References and Details
Uniform Administrative Requirements	<ul style="list-style-type: none">• 2 C.F.R. Part 200<ul style="list-style-type: none">○ Subpart A: Acronyms and Definitions○ Subpart B: General Provisions○ Subpart C: Pre-Federal Award Requirements and Contents of Federal Awards○ Subpart D: Post Federal Award Requirements
Cost Principles	2 C.F.R. Part 200, Subpart E
Audit Requirements	2 C.F.R. Part 200, Subpart F

5. DCM Award Closeout and Record Retention

Closeout

Within 90 days of the end of the period of performance, the non-Federal entity must submit a final SF-425 with a final narrative, detailing all accomplishments of the program, to both the FEMA GMO and Project Officer. The non-Federal entity must also liquidate all obligations within 90 days of the end of the period of performance as stated in 2 C.F.R. § 200.343. After FEMA reviews the final reports, the closeout process will begin. The closeout process will include an accounting of any remaining funds that must be obligated and will address the maintenance of Federal award records. Additional tools and resources for award closeout will be available in the online DCM Toolkit.

Record Retention

All recipients and subrecipients are subject to audit by FEMA and the Office of Inspector General personnel. Financial records, supporting documents, statistical records, and all other non-Federal entity records pertinent to a Federal award generally must be retained for at least three years from the date the final financial report is submitted.¹⁹¹ Further, if the recipient does not submit a final financial report and the award is administratively closed, FEMA issues the date of administrative closeout as the start of the general record retention period.

The record retention period may be longer than three years or have a different start date in certain cases. These include:

- Records for real property and equipment acquired with Federal funds must be retained for three years after final disposition of the property.¹⁹²
- If any litigation, claim, or audit is started before the expiration of the 3-year period, the records must be retained until all litigation, claims, or audit findings involving the records have been resolved and final action taken.¹⁹³
- The record retention period will be extended if the recipient is notified in writing of the extension by DHS/FEMA, the cognizant or oversight agency for audit, or the cognizant or oversight agency for audit, or the cognizant agency for indirect costs.¹⁹⁴
- Where DHS/FEMA requires recipients to report program income after the period of performance ends, the program income record retention period begins at the end of the recipient's fiscal year in which program income is earned.¹⁹⁵
- For indirect cost rate proposals, cost allocation plans, or other rate computations records, the start of the record retention period depends on whether the indirect cost rate documents were submitted for negotiation.
 - If the indirect cost rate documents were submitted for negotiation, the record retention period begins from the date those documents were submitted for negotiation.
 - If indirect cost rate documents were not submitted for negotiation, the record retention period begins at the end of the recipient's fiscal year or other accounting period covered by that indirect cost rate.¹⁹⁶

The non-Federal entity is responsible for returning any funds that are drawn down but remain unliquidated on non-Federal entity financial records.

Chapter 5: Crisis Counseling Assistance and Training Programⁱⁱⁱ

I. Overview

The Crisis Counseling Assistance and Training Program (CCP) is a Federally- funded supplemental program that provides financial assistance to state, local, territorial, or tribal (SLTT) government agencies through a grant or cooperative agreement. The CCP award enables SLTT government agencies to provide crisis counseling services or contract with local mental health service providers familiar with the affected communities to provide services.



Crisis Counseling

Crisis Counseling means the application of individual and group support designed to help alleviate the mental and emotional crises and their subsequent psychological and behavioral conditions resulting from a major disaster or its aftermath.

The intent of the CCP award is to augment, not replace, current mental health and training activities in order to assist disaster survivors. This program is only available after a Presidentially-declared disaster that includes Individual Assistance (IA), and a non-Federal entity has submitted an approved Federal award application. There is no cost-share.

The goal of the CCP services is to reach a large number of disaster survivors in a short period of time to prevent or mitigate adverse psychological effects caused or aggravated by a major disaster.

A. Overview of Services to Survivors

Services are provided at no cost and are available to any survivor, regardless of FEMA IHP applicant eligibility, who has been impacted by the disaster. These services are provided in accessible locations, including survivor homes, shelters, temporary living sites, and places of worship; they may even be provided virtually through a helpline. Services can be provided in a group setting or one-on-one and include supportive crisis counseling, education, development of coping skills, and linkage to appropriate resources.

CCP must be accessible to people regardless of race, color, national origin, sex, age, disability, English proficiency, or economic status. In particular, providers of CCP must plan to meet the needs of people with limited English proficiency and people with disabilities, such as people who are deaf or hard of hearing who may use sign language or captioning.

Characteristics of the program are described in *Figure 38*.

ⁱⁱⁱ OMB revised the regulations that govern federal grants and cooperative agreements, please refer to Title 2 of the Code of Federal Regulations for more details. See [Electronic Code of Federal Regulations](#).

Figure 38 : Characteristics of CCP	
Characteristic	Description
Strengths-based	Crisis counselors instill resilience in individuals and communities, and promote independence rather than dependence on the CCP, other people, or organizations. Crisis counselors help survivors regain a sense of control.
Outreach-oriented	Crisis counselors take services into the communities rather than wait for survivors to come to them.
More practical than psychological in nature	Crisis counseling is designed to prevent or mitigate adverse repercussions of disasters rather than to treat them. Crisis counselors provide support and education, listen to survivors, and accept the content at face value. Crisis counselors help survivors to develop a plan to address self-identified needs and suggest connections with other individuals or organizations that can assist them.
Diagnosis-free	Crisis counselors do not classify, label, or diagnose people; they keep no records or case files. The CCP does not provide mental health or substance use treatment, or critical incident stress debriefing. Services are supportive and educational in nature.
Conducted in non-traditional settings	Survivors can reach out to crisis counselors staffing helplines, or crisis counselors may make contact with survivors in their homes and communities, not in clinical office settings.
Culturally-aware	The CCP embraces cultural and spiritual diversity.
Designed to strengthen existing community support systems	Crisis counselors support, but do not organize or manage, community recovery activities. Likewise, the CCP supplements, but does not supplant or replace, existing community systems.
Provided in ways that promote a consistent program identity	Crisis counselors should work together early to establish a unified identity. The CCP strives to be a single, easily identifiable program, with services delivered by various local agencies.

B. Crisis Counseling vs. Traditional Mental Health Treatment

Mental health treatment, as typically defined within the professional community, implies the provision of assistance to individuals for a diagnosable disorder. In contrast, crisis counseling seeks to prevent the onset of diagnosable disorders by helping the majority of survivors understand that they are experiencing common reactions to extraordinarily uncommon occurrences.

A mental health professional often will engage a client in short or long-term recovery treatment, committing the person to a set number of sessions. The crisis counselor should treat each encounter as if it will be the only one, assisting the survivor with identifying needs and goals. Finally, while a traditional mental health professional will make a diagnosis and treat mental illnesses, the crisis counselor will avoid classifying, labeling, or diagnosing people in any way. The crisis counselor keeps no formal individual records or case files.

Differences between traditional mental health and the CCP services can be seen in *Figure 39*.

Figure 39: Mental Health vs Crisis Counseling Services	
Traditional Mental Health	Crisis Counseling
Office based	Home and community based
Diagnoses and treats mental illnesses	Assesses strengths and coping skills
Focuses on personality and functioning	Seeks to restore or improve functioning
Examines content	Accepts content at face value
Explores past experiences and their influence on current problems	Validates common reactions and experiences
Has psychotherapeutic focus	Has psycho-educational focus
Keeps records, charts, case files, etc.	Does not collect any identifying information
Makes reoccurring appointments	Treats each encounter as if it is the only one

C. Services Funded Through the CCP

The CCP award funds primary and secondary services. Primary services are high-intensity and include crisis counseling, public education, and community support. Secondary services are those that have a broader scope and are less intense and include development and distribution of psycho-educational material and public service announcements. Services that the program funds are described in *Figure 40*:

Figure 40: Services Funded through the CCP	
Services	Description
Individual crisis counseling	Helps survivors understand their reactions, improve coping strategies, reviews their options, and connect with other individuals in agencies that may assist them.
Basic supportive or educational contact	General support and information on resources and services available to disaster survivors.
Group crisis counseling	Group sessions led by trained crisis counselors who offer skills to help survivors cope with their situations and reactions.
Public education	Information and education about typical reactions, helpful coping strategies, and available disaster related resources.
Community networking and support	Relationship building with community resource organizations, faith-based groups, and local agencies.
Assessment, referral, and resource linkage	Adult and child needs assessment and referral to additional disaster relief services, mental health, or substance abuse treatment.
Development and distribution of educational materials	Flyers, brochures, tip sheets, educational materials, and website information developed by a non-Federal entity and distributed by the CCP staff.
Media and public services announcements	Media activities and public messaging in partnership with local media outlets, SLTT government, charitable organizations, or other community brokers.

D. General Conditions of Eligibility for a Federal CCP Award

All the following conditions must be met for an entity to be considered by FEMA and Substance Abuse and Mental Health Services Administration (SAMHSA) for a Federal CCP award:¹⁹⁷

- The President must declare a major disaster approved for IA.
- The need for crisis counseling services must be beyond the capabilities of the SLTT government to provide due to the severity and magnitude of the major disaster.
- The STT government and FEMA must execute a FEMA-State/Territory/Tribe Agreement.
- A CCP needs assessment must be initiated within 10 days of the date that IA was approved on the major disaster.
- The SLTT government mental health agency must be designated by the Governor, Governor's Authorized Representative (GAR), the Tribal Chief Executive, or the Tribal Chief Executive's Authorized Representative (TAR).
- The Federal award packet must be complete and submitted by the appropriate program application deadline.
 - Immediate Services Program (ISP): Application is due no later than 14 days from the date that IA was approved on the major disaster declaration.
 - Regular Services Program (RSP): Application is due no later than 60 days from the date that IA was approved on the major disaster declaration.



Eligible CCP Recipients

The definition of a Recipient, as per this guidance, is an STT government mental health agency, or other local or private mental health organization designated by the Governor, GAR, Tribal Chief Executive, or TAR, to receive funds under Section 416 of the Stafford Act.

This definition aligns with the program specific definition of a grantee, as per 44 C.F.R. § 206.171 (b)(5), and the Federal award definition of a recipient, as per 2 C.F.R. § 200.86.

The CCP application deadlines are set by regulation and cannot be waived or extended.

E. Waivers to Existing Policy

Any waivers to this CCP Guidance must be requested in writing, with justification, to the FEMA IA Division Director for consideration and a determination.

F. Authorities

FEMA is authorized to fund mental health assistance and training activities for survivors impacted by a Presidentially-declared disaster approved for IA under Section 416 of the Stafford Act,^{198 199} implementing regulations found in 44 C.F.R. § 206.171, and Federal award regulations found in 2 C.F.R. Part 200.

G. Partner Organizations

The Center for Mental Health Services (CMHS), within the SAMHSA, works in partnership with FEMA through an interagency agreement to provide technical assistance, consultation, award administration, program oversight, and training for STT government mental health authorities.

H. Types of Assistance

The CCP comprises two separate Federal award programs, the Immediate Services Program (ISP) and the Regular Services Program (RSP). An ISP is not a prerequisite for an RSP, nor is an RSP required if an ISP has been approved; however, separate Federal award applications and needs assessments must be completed for both programs, if both are requested. For more information on the ISP, see [Chapter 5, II](#). For more information on the RSP, see [Chapter 5, III](#). For additional information on staffing, stress management, data collection, and quality assurance, please see [Chapter 5, IV](#).

II. Immediate Services Program

A. Period of Assistance for ISP

The ISP provides funds for up to 60 days of services immediately following the date IA was approved on the major disaster declaration. ISP funding may continue for up to 60 additional days if an RSP award application is submitted to allow time for FEMA and SAMHSA to review the application. Notification must be provided, in writing, signed by the GAR or TAR, to FEMA no later than 45 days from the date of declaration if the STT government plans to submit an RSP application to receive an extension and ensure that there are no gaps in services. If extenuating circumstances exist, the FEMA RA may authorize an additional 30 days and/or supplemental funding, if needed, while the RSP application remains under review with FEMA.²⁰⁰

B. Pre-Award Assessment and Application

This section covers the pre-award considerations and process of applying for an ISP.

1. Needs Assessment

The purpose of the needs assessment is to provide an estimate of the size and cost of the program needed and to determine if supplemental Federal assistance is required.

The factors of the needs assessment must include:

- An estimate of the number of disaster survivors requiring assistance;
- A description of the SLTT government resources and capabilities; and
- Justification of why the SLTT government cannot meet the needs.

2. Applying for the Federal ISP Award

The cover letter for the ISP application should be addressed to the applicable Federal Coordinating Officer (FCO). The RA may delegate decision-making authority for the ISP to the FCO through the Disaster Recovery Manager (DRM) authority.

After the President declares a major disaster that includes IA, the applicable STT government may apply for the ISP. An ISP application package must be submitted to FEMA and SAMHSA within 14 days of the date IA was approved on the disaster. This application deadline is set by regulation and cannot be waived or extended.



Tailoring the Program to the Population

When assessing the needs of the affected population, it is important to consider the proportion and effect on the whole community, including older adults, people with disabilities and others with access and functional needs, children, and those with limited English proficiency. The program can be tailored to meet the needs of the specific community. For instance, if a high proportion of children were impacted, adding a children's coordinator in your staffing plan may be beneficial.



ISP Application Assistance

A completed and signed application and Federal forms are required to apply for the ISP. For application assistance, call SAMHSA DTAC at 800-308-3515.

An ISP application package represents the Governor or Tribal Chief Executive's agreement and/or certification:

- That the requirements are beyond the SLTT governments' capabilities;
- That the program, if approved, will be implemented according to the plan contained in the application approved by the applicable RA;
- To maintain close coordination with and provide reports to the RA, FEMA JFO and FEMA HQ staff, and SAMHSA Project Officer; and
- To include mental health disaster planning in the STT government's emergency plan prepared under Title II of the Stafford Act.

The application must contain the following information and documentation to be considered for an award (see CCP Online Toolkit):

Figure 41: ISP Application Required Information and Documents

<p>Information</p>	<ul style="list-style-type: none"> • The geographical areas within the designated disaster area for which services will be provided; • An estimate of the number of disaster survivors requiring assistance; • A description of the SLTT government resources and capabilities, and an explanation of why these resources cannot meet the need; • A description of activities from the date of the disaster incident to the date of application; • A plan of services to be provided to meet the identified needs; and • A detailed budget, showing the cost of proposed services separately from the cost of reimbursement for any eligible services provided prior to the application.
<p>ISP Application</p>	<p>The OMB approved ISP Application (1660-0085) must be completed and signed by the Governor or Tribal Chief Executive, or their Authorized Representative.</p>
<p>Request for Federal Assistance (SF-424)</p>	<p>A Federal form that OMB requires for Federal award applications. All entities that apply for CCP funds must submit a completed SF-424 signed by the Governor or GAR, or the Tribal Chief Executive or TAR.</p>
<p>Budget Information for Non-Construction Programs (SF-424A)</p>	<p>A Federal form OMB requires for Federal award applications. Complete "Section B—Budget Categories," column one only, for the total CCP budget.</p>
<p>Assurances for Non-Construction Programs (SF-424B)</p>	<p>A Governor, GAR, Tribal Chief Executive, or TAR signature is required.</p>
<p>Budget Narrative</p>	<p>The budget narrative should include a detailed justification for all cost categories requested in the SF-424A.</p>
<p>Lobbying Forms</p>	<p>SF-LLL and the Grants.gov Lobbying Certification Form must be on file with FEMA. The STT government must acknowledge that the forms are in compliance with the FEMA-State/Territory/Tribe Agreement and the most current <i>Department of Homeland Security (DHS) Standard Terms and Conditions</i>.</p>

3. Instructions for Submission of the ISP Application Package

Prior to the 14-day application deadline, the STT government must submit the completed ISP application packet to the applicable Federal Coordinating Officer. In order to expedite the review process, it is helpful if the STT government submits an electronic copy of the application to the applicable FEMA Joint Field Office (JFO), FEMA Headquarters (HQ), and SAMHSA staff. Once received, the FEMA Human Services Group Supervisor at the FEMA JFO, FEMA Community Services Specialist at FEMA HQ, and the SAMHSA Project Officer will review the application to ensure all required documentation meet the minimum eligibility requirements per 44 C.F.R. § 206.171 and the General Terms and Conditions outlined in 2 C.F.R. § 200.210.

4. Budget

The ISP budget narrative must justify the proposed budget for the STT government and subrecipients and each individual service provider's budget. The narrative must provide a justification of the costs and an itemization for each line of the budgets.

Pre-Award Costs—Allowable: Pre-award costs are those which are: a) incurred prior to the effective date of the Federal award, and b) directly pursuant to the negotiation and in anticipation of the Federal award where such costs are necessary for efficient and timely performance of the scope of work. Such costs are allowable under the ISP award only to the extent that they would have been allowable if incurred after the date of the Federal award and only with written approval of the Federal Coordinating Officer (FCO).²⁰¹

The STT government may seek reimbursement for pre-award costs associated with crisis counseling services provided from the date of the disaster incident to the date of major disaster declaration. The STT government must document the crisis counseling services provided and justify the costs.

Documentation should include the following:

- Types of crisis counseling services provided
- Location of service provision
- Types of staff who provided the services
- Hourly rates of staff who provided the services
- Number of hours that staff worked
- Number of disaster survivors who received services and types of services provided

The STT government may seek reimbursement only for crisis counseling services and not for any other type of behavioral health response. Crisis counseling services are typically provided during the immediate disaster response phase to survivors and their families, first responders, and other individuals directly affected by the disaster. Typical locations of service provision in the immediate disaster response include shelters, family assistance centers, homes, or other community settings.

Services often are provided by behavioral health agency staff, local behavioral health service provider staff, or members of disaster behavioral health response groups. Reimbursement for staff costs is allowable if it can be clearly demonstrated that the normal duties of the staff (if employed by the STT government during the disaster) were back-filled during the disaster response.

Indirect Costs—Unallowable: FEMA does not authorize the use of funds for indirect costs. Indirect costs, including management costs, are defined as costs not directly chargeable to a specific project. Please note that even if an indirect cost rate is established, it is subject to statutory and administrative limitations. A CCP award recipient or provider is not entitled to an established rate for services provided under the CCP award. The program's statutes, regulations, and policy govern whether any indirect costs are eligible. Section 324 of the Stafford Act requires FEMA to establish management cost rates through regulations. At this time, FEMA does not have regulations that govern the eligibility of indirect costs for the CCP.

Salaries and Wages: Salary compensation must be reasonable in amount and in alignment with local prevailing rates for the position funded.

Fringe Benefits: Fringe benefits may be charged directly to the grant. Claimed costs must be reasonable and conform to established policies for the STT government. Use of a pre-established provisional rate requires allocation to total salary costs. Rates must be adjusted to actuals at the year-end and rates should be reviewed at least once annually.

Consultant Costs: Consultant costs must be supported by a consulting agreement that documents the service to be performed, cost, and applicable time periods. Documentation to support need, reasonable rates, and consultant expertise must be maintained, together with evidence of work product.

Equipment: The STT government obtains title to equipment acquired under the CCP award and is subject to the conditions outlined in 2 C.F.R. § 200.313, including these requirements:

- To use the equipment for the authorized purposes of the project until funding for the project ceases, or until the property is no longer needed for the purposes of the project.
- To not encumber the property without approval of FEMA.
- To use and dispose of the property in accordance with 2 C.F.R. § 200.313.
- To use the equipment in a manner consistent with the purposes of the CCP award and to benefit the beneficiaries of the CCP project.

Supplies: FEMA retains an interest in any unused supplies exceeding \$5,000 in total aggregate value upon termination or completion of the CCP if they are not needed for any other Federal award. The STT government must compensate FEMA for its share of the supplies in compliance with 2 C.F.R. § 200.313 and § 200.314. As long as FEMA retains an interest in supplies, the STT government must not use the supplies to provide services to other organizations for a fee that is less than private companies charge for equivalent services.

Travel: Travel must be included in the budget for preapproval as part of the application process. During implementation, travel costs must be supported by travel expense reports detailing employee name, the reason for the trip, and itemized expenses claimed. Claimed costs should be charged according to the award recipient's travel policy, which requires prior approval from FEMA and SAMHSA, compliance with OMB cost principles, and provides expenditure limitations. Major items of expense (e.g., airfare, lodging) must be supported by receipts.

Other: The budget may identify costs that are unique to the disaster and area impacted but do not fall into one of the prescribed cost categories listed above. Costs must be supported by adequate documentation (invoices, receipts, etc.). Consult with the FEMA specialists or the SAMHSA Program Officer to determine which costs are allowable under this cost category.

Contractual Costs: The non-Federal entity must follow the applicable Federal procurement requirements at 2 C.F.R. § 200.317 through § 200.326. Per 2 C.F.R. § 200.317, states must follow the same policies and procedures they normally use as well as comply with the requirements for procurement of recovered materials (§ 200.322) and including required contract provisions (§ 200.326). For all other non-Federal entities, including tribes, they must follow all of the requirements at 2 C.F.R. § 200.318 through §200.326. As part of these requirements, non-state entities must use their own documented procurement procedures that reflect applicable state, local, and tribal laws and regulations provided that the procurements comply with Federal law and the Federal procurement regulations. As a note, hiring of consultants falls under the procurement requirements, so non-Federal entities must follow applicable procurement regulations at 2 C.F.R. § 200.317 – 200.326.

For more information on allowable and unallowable costs, refer to the [Appendix F](#).

C. Approval Process for ISP

The FCO may approve or deny the ISP in coordination with SAMHSA. The program may be approved for a period of performance of 60 days from the date IA was authorized in the major disaster declaration if:

- A complete application is received no later than 14 days from the date of declaration; and
- There is a need for the program clearly articulated in the application.

If approved, the FCO will submit a written approval with justification to the STT government agency receiving the award.

The program may be denied if:

- A complete application is not received within 14 days from the date IA was authorized in the major disaster declaration; or
- The application lacks sufficient information to justify the need for the program.

If denied, the FCO must submit a written denial with justification to the STT government agency that applied for the award and the Governor, GAR, Tribal Chief Executive, or TAR.

1. Federal and Congressional Review Process for ISP

Once submitted, the non-Federal entity's CCP application will go through a review by FEMA HQ, FEMA JFO, and FEMA Region staff for completeness, cost-effectiveness, and feasibility of the non-Federal entity's CCP application. The FEMA FCO will issue a determination.

All Federal awards greater than \$1,000,000 must be routed to the Congressional Appropriations Committee for advanced notification review. This process may add multiple weeks to the timeline before obligating the Federal award. Once the notification process is complete, the FEMA FCO is notified that the funds can be released and the FCO may issue the notice of award to the recipient after the mandatory 72 hour waiting period.

D. Notice of Award (NOA) for ISP

When the non-Federal entity has been approved for a Federal CCP award, they will receive a Notice of Award (NOA). The NOA is the official document notifying the recipient and others that a Federal award has been made. The recipient will receive an NOA from the applicable FEMA RA. The NOA contains all terms and conditions of the Federal award and supporting documentation for recording the obligation of Federal fund in the recipients accounting system. Important information included in the NOA:

- The start and end dates for the program's period of performance
- The award amount
- Name of the FEMA and SAMHSA program officers
- Reporting requirements

1. Conditions of Award

Conditions of Award, or Terms and Conditions and/or Special Conditions, are requirements that the recipient must satisfy within the timeframe specified in the NOA. Failure to comply with all terms and conditions of a Federal award may result in funding restrictions, award termination, and/or denial of any future funding.

E. Post-Award Requirements

This section covers the post-award requirements of the Immediate Services Program, including training requirements, reporting requirements, and extensions.

1. Training

Training materials and recommendations for qualified trainers are provided by SAMHSA and through SAMHSA Disaster Technical Assistance Center (DTAC). Often, personnel from other assistance and disaster relief agencies are invited to attend.

The required standard CCP trainings are organized into modules that are provided to recipients by SAMHSA DTAC once a CCP is approved. Required trainings include:

- **Core Content Training:** This is the basic CCP skills-building training and includes administrative procedures and data collection information specific to the program. The course takes place in two days, during which time crisis counselors are provided with critical information and skills related to individual, group, and community outreach strategies. This training is conducted during the first few weeks of the ISP. However, ongoing training must be provided to ensure all new crisis counselors receive the Core Content Training prior to working independently within the program.

2. Reporting Requirements for the ISP

The recipient must submit to the appropriate FEMA FCO:²⁰²

- A mid-program report only when an RSP award application is being prepared and submitted. This report will be included as part of the RSP Federal award application;
- A final program report; and
- A financial status report.

This documentation is due no more than 90 days after the last day of immediate services funding.

3. Extensions

ISP Extension of the Period of Performance

ISP funding may continue for up to 60 additional days if an RSP award application is submitted to allow time for FEMA and SAMHSA to review the application. Notification must be provided, in writing, to FEMA and SAMHSA no later than 45 days from the date of declaration if the STT government plans to submit an RSP application to receive a continuation and ensure there are no gaps in services. If extenuating circumstances exist, the FEMA RA may authorize an additional 30 days and/or supplemental funding, if needed, while the RSP application remains under review with FEMA.

During the ISP period of performance, the STT government must notify FEMA program officer and SAMHSA program officer, no later than 45 days from the date of declaration, if they are planning to submit an application for the RSP award.²⁰³

ISP No-Cost Administrative Extension

All costs associated with finalizing the program and financial reports are allowable costs, as long as those costs are included in the approved ISP budget. In order for these costs to be covered, the STT government must request for a no-cost administrative extension to the ISP award period of performance. The STT government must submit the written extension request to their FEMA Regional office prior to the end of the period of performance. A no-cost administrative extension can be granted for up to 30 days when requested in writing and approved by the FCO. In exceptional circumstances, an additional 30-day no-cost administrative extension may be approved by FEMA if the submitted written request demonstrates sufficient need.

Any programmatic or service activities (not related to the ISP final report) conducted after the period of performance will not be funded under the CCP award. Any extension granted for the ISP once the RSP is awarded is only for work associated with finalizing the program and financial reports of providers to the recipient.

F. Closeout and Records Retention

1. ISP Closeout

The final ISP program narrative and fiscal report (*Federal Financial Report SF-425*) are due to the FCO, no later than 90 calendar days after the last day of the ISP award's period of performance. The STT government must liquidate all obligated balances, and show the exact balance of funds and total expenditures, which must be consistent with the line-item report. The final SF-425 must show the total Federal award amount, total Federal expenditures, and the unobligated balance. The reported total Federal expenditures reflected on the SF-425 report must be consistent with the line-item expenditures reflected in the program report.

2. ISP Record Retention

Financial records, supporting documents, statistical records, and all other non-Federal entity records pertinent to a Federal award generally must be retained for at least three years from the date the final financial report is submitted.²⁰⁴ Further, if the recipient does not submit a final financial report and the award is administratively closed, FEMA sees the date of administrative closeout as the start of the general record retention period.

The record retention period may be longer than three years or have a different start date in certain cases. These include:

- Records for real property and equipment acquired with Federal funds must be retained for three years after final disposition of the property.²⁰⁵
- If any litigation, claim, or audit is started before the expiration of the three-year period, the records must be retained until all litigation, claims, or audit findings involving the records have been resolved and final action taken.²⁰⁶
- The record retention period will be extended if the recipient is notified in writing of the extension by DHS/FEMA, the cognizant or oversight agency for audit, or the cognizant or oversight agency for audit, or the cognizant agency for indirect costs.²⁰⁷
- Where DHS/FEMA requires recipients to report program income after the period of performance ends, the program income record retention period begins at the end of the recipient's fiscal year in which program income is earned.²⁰⁸
- For indirect cost rate proposals, cost allocation plans, or other rate computations records, the start of the record retention period depends on whether the indirect cost rate documents were submitted for negotiation.
 - If the indirect cost rate documents were submitted for negotiation, the record retention period begins from the date those documents were submitted for negotiation.
 - If indirect cost rate documents were not submitted for negotiation, the record retention period begins at the end of the recipient's fiscal year or other accounting period covered by that indirect cost rate.²⁰⁹

The non-Federal entity is responsible for returning any funds that are drawn down but remain unliquidated on non-Federal entity financial records.

III. Regular Services Program

A. Period of Assistance for RSP

The RSP provides funds for up to nine months of services immediately following the date of the Notice of Award. If needed, STT government may request up to a 90-day extension to the period of performance in writing to the appropriate FEMA Regional Administrator (RA). This request must document the extraordinary circumstances and what the additional time will allow them to accomplish. In limited circumstances, such as disasters of catastrophic nature, the FEMA RA may extend the period of performance for more than 90 days when they deem it to be in the public interest.²¹⁰

B. Pre-Award Assessment and Application

This section covers the pre-award requirements and process of applying for a Regular Services Program.

1. Needs Assessment

The purpose of the needs assessment is to provide an estimate of the size and cost of the program needed and to determine if supplemental Federal assistance is required. The factors of the needs assessment must include:

- An estimate of the number of disaster survivors requiring assistance;
- A description of the SLTT government resources and capabilities; and
- Justification of why the SLTT government cannot meet the needs.



Tailoring the Program to the Population

When assessing the needs of the affected population, it is important to consider the proportion and effect on the whole community, including older adults, people with disabilities and others with access and functional needs, children, and those with limited English proficiency. The program may be tailored to meet the needs of the specific community. For instance, if a high proportion of children were impacted, adding a children's coordinator in your staffing plan may be beneficial.

2. Applying for the Federal RSP Award

The cover letter for the RSP application should be addressed to the applicable FEMA RA. As per the 2018 Delegation of Authority, the FEMA RAs have the authority to approve or disapprove an application for the RSP. Note that the Disaster Recovery Manager authority does not carry the delegation of the RSP determination.

After the President declares a major disaster that includes IA, the applicable STT government may apply for the RSP. The RSP application package must be submitted to FEMA and SAMHSA no later than 60 days following the date IA was approved on the disaster. This application deadline is set by regulation and cannot be waived or extended.

An RSP application package represents the Governor or Tribal Chief Executive's agreement and/or certification:

- That the requirements are beyond the SLTT government's capabilities;
- That the program, if approved, will be implemented according to the plan contained in the application approved by the applicable FEMA RA;
- To maintain close coordination with and provide reports to the applicable FEMA RA, FEMA HQ, and FEMA JFO staff, and SAMHSA Project Officer and Grants Officer; and
- To include mental health disaster planning in the STT government's emergency plan prepared under Title II of the Stafford Act.

The application must contain the information and documentation found in *Figure 42* to be considered for an RSP award (see CCP Toolkit):

Figure 42: RSP Application Required Information and Documents

<p>Information</p>	<ul style="list-style-type: none"> • The geographical areas within the designated disaster area for which services will be provided; • An estimate of the number of disaster survivors requiring assistance; • A description of the SLTT government resources and capabilities, and an explanation of why these resources cannot meet the need; • A description of activities from the date of the disaster incident to the date of application; • A plan of services to be provided to meet the identified needs; and • A detailed budget, showing the cost of proposed services separately from the cost of reimbursement for any eligible services provided prior to the application.
<p>RSP Application</p>	<p>The OMB approved RSP Application (1660-0085) must be completed and signed by the Governor or Tribal Chief Executive, or their Authorized Representatives.</p>
<p>Request for Federal Assistance (SF-424)</p>	<p>A Federal form OMB requires for Federal award applications. All entities that apply for CCP funds must submit a completed SF-424 signed by the authorized representative of the non-Federal entity receiving funds.</p>
<p>Budget Information for Non-Construction Programs (SF-424A)</p>	<p>A Federal form OMB requires for Federal award applications. Complete “Section B-Budget Categories,” Column 1 only for the total CCP budget.</p>
<p>Assurances for Non-Construction Programs (SF-424B)</p>	<p>A signature from the authorized representative of the non-Federal entity receiving the funds is required.</p>
<p>Budget Narrative</p>	<p>The budget narrative must include a detailed justification for all cost categories requested in the SF-424A. Refer to Appendix F for additional instructions on completing the budget narrative.</p>
<p>Health and Human Services (HHS) Checklist</p>	<p>A required form for an RSP that ensures pertinent documents, information, certifications, and assurances are included in the application, to include acknowledgement by the STT government that the forms are in compliance with the most current DHS Standard Terms and Conditions.</p>
<p>Disclosure of Lobbying Activities (SF-LLL)</p>	<p>A required form for the CCP RSP. The STT government may indicate “N/A” on the form if it is not applicable.</p>
<p>Project/Performance Site Locations</p>	<p>A Federal form required for the CCP RSP. The STT government should complete a form for each site where providers will perform project work.</p>

3. Instructions for Submission of the RSP Application Package

Prior to the 60-day application deadline, the STT government must submit the completed RSP application package to the applicable FEMA RA. In order to expedite the review process, it is helpful if the STT government submits an electronic copy of the application to the applicable FEMA JFO Human Services Group Supervisor, FEMA HQ Community Services Program Specialist, and SAMHSA Project Officer. Once received, the FEMA Human Services Group Supervisor at the FEMA JFO, FEMA Community Services Specialist at FEMA HQ, and the SAMHSA Project Officer and Grants Officer will review the application to ensure all required documentation meets the minimum eligibility requirements per 44 C.F.R. § 206.171 and the General Terms and Conditions outlined in 2 C.F.R. § 200.210.

4. Budget

The RSP budget narrative must justify the proposed budget for the STT government and subrecipients and each individual service provider's budget. The narrative must provide a justification of the costs and an itemization for each line of the budgets.

Indirect Costs—Unallowable: FEMA does not authorize the use of funds for indirect costs. Indirect costs, including management costs, are defined as costs not directly chargeable to a specific project. Please note that even if an indirect cost rate is established, it is subject to statutory and administrative limitations. A CCP award recipient or provider is not entitled to an established rate for services provided under the CCP award. The program's statutes, regulations, and policy govern whether any indirect costs are eligible. Section 324 of the Stafford Act requires FEMA to establish management cost rates through regulations. At this time, FEMA does not have regulations that govern the eligibility of indirect costs for the CCP.

Salaries and Wages: Salary compensation must be reasonable in amount and in alignment with local prevailing rates for the position funded.

Fringe Benefits: Fringe benefits may be charged directly to the grant. Claimed costs must be reasonable and confirm to established policies for the STT government. Use of a pre-established provisional rate requires allocation to total salary costs. Rates must be adjusted to actuals at the year-end and rates should be reviewed at least once annually.

Consultant Costs: Consultant costs must be supported by a consulting agreement that documents the service to be performed, cost, and applicable time periods. Documentation to support need, reasonable rates, and consultant expertise must be maintained, together with evidence of work product.

Equipment: The STT government obtains title to equipment acquired under the CCP award and is subject to the conditions outlined in 2 C.F.R. § 200.313, including these requirements:

- To use the equipment for the authorized purposes of the project until funding for the project ceases, or until the property is no longer needed for the purposes of the project.
- To not encumber the property without approval of FEMA.
- To use and dispose of the property in accordance with 2 C.F.R. § 200.313.
- To use the equipment in a manner consistent with the purposes of the CCP award and to benefit the beneficiaries of the CCP project.

Supplies: FEMA retains an interest in any unused supplies exceeding \$5,000 in total aggregate value upon termination or completion of the CCP if they are not needed for any other Federal award. The STT government must compensate FEMA for its share of the supplies in compliance with 2 C.F.R. § 200.313 and § 200.314.

As long as FEMA retains an interest in supplies, the STT government must not use the supplies to provide services to other organizations for a fee that is less than private companies charge for equivalent services.

Travel: Travel must be included in the budget for preapproval as part of the application process. During implementation, travel costs must be supported by travel expense reports detailing employee name, the reason for the trip, and itemized expenses claimed. Claimed costs should be charged according to the award recipient's travel policy, which requires prior approval from FEMA and SAMHSA, compliance with OMB cost principles, and provides expenditure limitations. Major items of expense (e.g., airfare, lodging) must be supported by receipts.

Other: The budget may identify costs that are unique to the disaster and area impacted but do not fall into one of the prescribed cost categories listed above. Costs must be supported by adequate documentation (invoices, receipts, etc.). Consult with the FEMA Specialists or SAMHSA Program Officer to determine which costs are allowable under this cost category.

Contractual Costs: The STT government will follow its established policies and procedures used for procurements from non-Federal funds when procuring property and services under a Federal award. All other states, territories or tribes will follow the requirements in 2 C.F.R. § 200.318, General Procurement Standards, through § 200.326, Contract Provisions. All states, territories or tribes should review the procurement standards outlined in 2 C.F.R. § 200.317 through § 200.326.

For more information on allowable and unallowable costs, refer to [Appendix F](#).

C. Approval Process for RSP

The RA may approve or deny the RSP in coordination with SAMHSA. The program may be approved for a period of performance of nine months from the date of award if:

- A complete application is received no later than 60 days from the date of declaration; and
- There is a need for the program clearly articulated in the application.

If approved, the RA must submit a written approval with justification to the Chief of the Emergency Mental Health and Traumatic Stress Services Branch at SAMHSA for processing and award of the grant to the STT government agency receiving the award.

The program may be denied if:

- A complete application is not received by 60 days from the date of declaration; or
- The application lacks sufficient information to justify the need for the program.

If denied, the RA must submit a written denial with justification to the applicant agency and GAR/TAR.

Under the 2018 Delegation of Authority, the FEMA RAs have authority to approve or deny an application for the RSP. This authority is not delegated with the DRM authority.

1. Federal and Congressional Review Process for RSP

Once the RSP application is submitted, the non-Federal entity's RSP application will go through a review by SAMHSA, FEMA HQ, FEMA JFO, and FEMA Region staff for completeness, cost-effectiveness, and feasibility of the non-Federal entity's RSP application. The FEMA RA will issue a determination.

All Federal awards greater than \$1,000,000 must be routed to the Congressional Appropriations Committee for advanced notification review. This process may add multiple weeks to the timeline before obligating the Federal award. Once the notification process is complete, the FEMA RA is notified that funds can be released and the RA may notify SAMHSA, in writing, that they may issue the notice of award to the recipient after a minimum of 72 hours.

D. Notice of Award (NOA) for RSP

When the non-Federal entity has been approved for a Federal CCP award, they will receive a Notice of Award (NOA). The NOA is the official Federal award document notifying the award recipient and others that an award has been made. The recipient will receive an NOA from SAMHSA. The NOA contains all terms and conditions of the Federal award and supporting documentation for recording the obligation of Federal fund in the recipients accounting system. Important information included in the NOA:

- The start and end dates for the program's period of performance
- The award amount
- Name of the FEMA and SAMHSA Program Officers
- Name of the SAMHSA Grants Management Officer
- Reporting requirements



CCP Toolkit

SAMHSA and the SAMHSA Disaster Technical Assistance Center (DTAC), in collaboration with FEMA, have established and maintain an online CCP Toolkit containing required documents and tools to assist stakeholders in preparing, applying, implementing, managing, and closing out a CCP.

If you would like to speak with a SAMHSA Project Officer, please email SAMHSA DTAC at DTAC@samhsa.hhs.gov or call 800-308-3515 (Monday-Friday 9 A.M. to 5 P.M. Eastern time) and a staff member will forward your request to the appropriate project officer.

1. Conditions of Award

Conditions of Award, or Terms and Conditions and/or Special Conditions, are requirements that the recipient must satisfy within the timeframe specified in the NOA. Failure to comply with all terms and conditions of a Federal award may result in funding restrictions, award termination, and/or denial of any future funding.

E. Post-Award Requirements

This section covers the post-award requirements for a Regular Services Program, including training, reporting requirements, and extensions.

1. Training

Training materials and recommendations for qualified trainers are provided by SAMHSA and through SAMHSA DTAC. Often, personnel from other assistance and disaster relief agencies are invited to attend

The required standard CCP trainings are organized into modules that are provided to recipients by SAMHSA DTAC once a CCP is approved. Required trainings include:

- **Core Content Training:** This is the basic CCP skills-building training and includes administrative procedures and data collection information specific to the program. The course takes place over two days, during which time crisis counselors are provided with critical information and skills related to individual, group, and community outreach strategies. This training is conducted during the first few weeks of the ISP; however, if no ISP is implemented, the training will need to be conducted during the RSP. However, ongoing training must be provided to ensure all new crisis counselors receive the Core Content Training prior to working independently within the program.
- **Transition to RSP Training:** During this course, existing and newly hired CCP staff review key concepts related to crisis counseling skills, with an emphasis on longer-term service provision. This curriculum highlights how the needs of disaster survivors and communities evolve in the RSP and differ from those encountered in the immediate disaster response. If the STT government applied for the RSP only, it should begin with the Core Content Training. This training usually takes place as soon as formal RSP grant funding is awarded.
- **RSP Mid-Program Training:** This training typically is held 3-6 months into the RSP. Issues of staff morale and stress management for subrecipients are addressed. A focus is maintained on how crisis counselors will continue to provide services under difficult circumstances. This training includes problem-solving techniques for specific issues commonly encountered in the CCP such as emerging substance use or significant mental health needs. It also begins to address the subject of program phasedown.
- **Disaster Anniversary Training:** This training is held several weeks before the first anniversary of the disaster event. Crisis counselors are taught expected anniversary reactions and intervention strategies. This training can be paired with the Mid-program Training or the Phasedown Training, depending on the anniversary date.

- **RSP Phasedown Training:** This training should take place six–eight weeks prior to the scheduled phasedown of the CCP. All CCP administrative and outreach staff attend. Topics in this training include staff stress management and future planning, assisting the program and its staff to document the event, planning to leave a legacy for the community, resource linkage and referrals, and continuity of service via community partnerships.

The CCP training plan is not limited to providing required trainings. The STT government should identify and deliver additional trainings based on specific disaster and staff needs. Additional recommended training areas include more in-depth learning about specific crisis counseling interventions, as well as cultural competence, working with children, and mental health or substance use assessment and referral.

To promote community partnerships, the CCP leadership is encouraged to share training opportunities with other disaster and community providers. In quarterly reports, programs should document training sessions held, describe the content of the sessions, and note the number of people who attended. As highlighted in the training section of this document, required training takes place throughout the program period and should be planned in a proactive manner.

Optional training may take place, as deemed appropriate by the STT government.

2. Reporting Requirements for the RSP

For the RSP, quarterly reports, including documentation on financial expenditures, must be submitted to the FEMA Headquarters Program Specialist; the FEMA JFO Specialist (or Regional Specialist if the FEMA JFO is demobilized); and the SAMHSA Project Officer. Quarterly reports are due 30 calendar days after the end of each three-month reporting period (refer to the NOA for specific due dates). The quarterly report must include a budget expenditure report for the STT government and any subrecipients, showing:

- The approved budget;
- Costs incurred and obligated expenditures;
- Approved budget modifications; and
- Remaining balance of unspent funds.

The report should be consistent with the cost categories and budget line items listed in the approved budget. If only a portion of award funding is disbursed at the start of the RSP, the STT government must submit a letter of request for the second allotment of funds with the first quarterly RSP report.

3. Extensions

RSP Extension of the Period of Performance

The RSP provides funds for up to nine months of services immediately following the date of the NOA. If needed, the STT government may request supplemental funding and/or up to a 90-day extension to the period of performance in writing to the appropriate FEMA RA; this request must document the extraordinary circumstances and what the additional funding and/or time will allow them to accomplish. In limited circumstances, such as disasters of catastrophic nature, the FEMA RA may extend the period of performance for more than 90 days where they deem it to be in the public interest.²¹¹

RSP No-Cost Administrative Extension

All costs associated with finalizing the program and financial reports are allowable costs, as long as those costs are included in the approved RSP budget. In order for these costs to be covered, the STT government must request for a 90-day no-cost administrative extension to the RSP award period of performance. The STT government must submit the written extension request to SAMHSA and FEMA no later than one month prior to the end of the period of performance. Any programmatic or service activities (not related to the RSP closeout) conducted after the period of performance will not be funded under the CCP award.

When an STT government provides a subaward to a subrecipient, the STT government must include the start and end dates of the period of performance in the subaward document.

F. Closeout and Records Retention

1. RSP Closeout

The final RSP program report and the Federal Financial Report SF-425 form (OMB form number 0348-0061) are due to FEMA and SAMHSA 90 calendar days after the end of the period of performance. Note that the reported total Federal expenditures reflected on the SF-425 report must be consistent with the line-item expenditures reflected in the program report.

2. RSP Record Retention

Financial records, supporting documents, statistical records, and all other non-Federal entity records pertinent to a Federal award generally must be retained for at least three years from the date the final financial report is submitted.²¹² Further, if the recipient does not submit a final financial report and the award is administratively closed, FEMA sees the date of administrative closeout as the start of the general record retention period.

The record retention period may be longer than three years or have a different start date in certain cases. These include:

- Records for real property and equipment acquired with Federal funds must be retained for three years after final disposition of the property.²¹³
- If any litigation, claim, or audit is started before the expiration of the three-year period, the records must be retained until all litigation, claims, or audit findings involving the records have been resolved and final action taken.²¹⁴
- The record retention period will be extended if the recipient is notified in writing of the extension by DHS/FEMA, the cognizant or oversight agency for audit, or the cognizant or oversight agency for audit, or the cognizant agency for indirect costs.²¹⁵
- Where DHS/FEMA requires recipients to report program income after the period of performance ends, the program income record retention period begins at the end of the recipient's fiscal year in which program income is earned.²¹⁶
- For indirect cost rate proposals, cost allocation plans, or other rate computations records, the start of the record retention period depends on whether the indirect cost rate documents were submitted for negotiation.

- If the indirect cost rate documents were submitted for negotiation, the record retention period begins from the date those documents were submitted for negotiation.
- If indirect cost rate documents were not submitted for negotiation, the record retention period begins at the end of the recipient's fiscal year or other accounting period covered by that indirect cost rate.²¹⁷

The non-Federal entity is responsible for returning any funds that are drawn down but remain unliquidated on non-Federal entity financial records.

IV. Considerations for Implementation of ISP and RSP

This section provides information regarding staffing a CCP, collecting data, modifying budget and program plans, and appealing various decisions regarding both an ISP and an RSP.

A. Main Components of a Program Management Plan

The recipient is responsible for developing a program management plan. The components of the program management plan may vary given the needs of the non-Federal entity and the scope of the disaster. Typical components include the following:

- Performing ongoing needs assessment
- Developing and effecting outreach strategies to identify and serve affected individuals, groups, and the community, including distinct outreach strategies for different populations, as well as accessibility to all survivors.
- Ensuring supervision and quality assurance at the STT government and subrecipient levels
- Identifying and tracking resource referrals.
- Employing program media and marketing strategies
- Recruiting and hiring staff
- Providing training
- Providing staff stress management
- Ensuring effective fiscal management
- Accomplishing program evaluation

B. Media and Marketing the CCP

It is important for the recipient to select a name in order to develop a cohesive identity among the sub-recipients. All CCP staff need to share a group identity. This is achieved through training and use of media and marketing strategies that define program services and inform the community about the CCP. Strategies to build a program identity and to market services include the following:

- **Developing a brand for the program:** Establishing a clearly recognizable program name and logo or design elements that appear on all program materials. Staff members are provided with items, such as t-shirts, with the specific program name and logo.
- **Using media outlets:** Recipients may develop public service announcements, interviews, articles, advertisements, letters to the editor, or educational material.
- **Establishing toll-free numbers or hotlines:** A toll-free line may be established purely for informational purposes, or a hotline that provides counseling via phone may be incorporated into the CCP program.
- **Establishing program websites:** Recipients may establish a program website that explains the CCP services and links to other disaster-related resources whenever possible.

- **Developing and revising outreach and psycho-educational materials:** Recipients may develop materials that are tailored to address the unique characteristics of a specific disaster or CCP.
- **Promoting word-of-mouth promulgation:** Outreach workers may encourage people to spread the word about CCP.

C. Staffing of the CCP

The needs assessment will inform required CCP staff roles and the number of individuals needed for each position to be included in the staffing plan. The non-Federal entity determines how staff members are deployed to meet the needs of disaster survivors and at-risk groups. For safety and efficacy, crisis counselors typically are deployed in teams. Team deployment is linked with the CCP outreach strategy in order to target services to those individuals and groups identified to be in the greatest need. In its essential staffing, the CCP should reflect the cultural demographics of the affected area and use paraprofessionals with prior training and experience in the mental health and substance use fields. For additional information on training, refer to the CCP Toolkit.

1. Staff Stress Management

Many staff members of a CCP are also survivors of the disaster. Interacting with disaster survivors is rewarding but may also produce strong levels of anxiety, frustration, anger, or depression in some workers. Sustained service provision can become debilitating when coupled with a staff member's personal experience of loss. It is, therefore, critical that ongoing staff stress management is integrated into the CCP at all levels of the program. All standard CCP trainings provided by SAMHSA include content on individual staff stress management. The program management plan developed by the recipient must include provisions for organizational stress management. Elements of an organizational stress management plan are as follows:

- A clearly defined management and supervision structure
- Defined purpose and goals
- Functionally defined roles reinforced through effective supervision
- Sound clinical consultation, support, and supervision
- Supportive peer relationships
- Active stress management program
- Comprehensive training plan

D. Data Collection, Evaluation, and Reporting

Consistent and timely data collection and evaluation are necessary to measure success of outreach efforts and the changing needs of disaster survivors. The recipient's program management plan should include mechanisms to collect, examine, and react to immediate and changing needs encountered by crisis counselors. Frequent analysis of both CCP data and feedback provided by staff allows the program to evolve to meet needs as they arise. The process improves the program's behavioral health disaster response, documents the program's accomplishments, and provides accountability information to stakeholders. SAMHSA and FEMA also use data to justify program efforts, as well as to make modifications to the CCP model and program service delivery. The recipient is required to submit a summary of up-to-date program data with their programmatic quarterly and final reports.

Procedures for data collection and evaluation include the following:

- Establishment of quality control and assurance processes is necessary for data collection and analysis. Typical quality control procedures include management review of forms for completeness prior to approval; staff review for consistency and accuracy, and giving feedback to the subrecipient-level supervisors; and staff developing ways to resolve errors in collected data forms.
- All CCP administrators and managers should carefully review evaluation and reporting requirements.
- The CCP award conditions require collecting information on specific forms in specific formats. This should not limit the STT government and subrecipients in collecting additional information that will assist in both program improvement and process. The specific required forms are detailed in the NOA.
- The Federal CCP award conditions require database development and data delivery to SAMHSA upon submission of each quarterly report and with the final report.
- Data on service delivery must be collected using the Individual/Family Crisis Counseling Services Encounter Log, Group Encounter Log, Weekly Tally Sheet, and the Child/Youth and Adult Assessment and Referral Tools, each a part of the standard FEMA CCP Toolkit as approved by the OMB (OMB No. 0930-0270). The Participant Feedback Survey and Service Provider Feedback Survey are also included in the CCP Toolkit.

E. Quality Assurance

The CCP is a time-limited program that must identify and address emergent issues related to both disaster survivor needs and operational realities, while developing and implementing solutions to improve program services. Quality assurance and quality improvement activities are developed even before the program begins and assist the STT government in reporting program highlights and issues to SAMHSA and FEMA through regular program monitoring and reporting. Activities related to quality assurance include the following:

- Regular onsite supervision, training, and consistent communication between CCP management and workers providing services
- Weekly meetings and regular submission of data collection forms to the SAMHSA Program Officer and FEMA Specialist

- Phone and email communication whenever workers have questions or concerns
- Collecting and organizing programmatic materials and data to continue to improve service provision and educational materials
- Identifying problems or gaps in service through data and informant feedback
- Redirecting resources and modifying the service plan
- Conducting ongoing needs assessment
- Providing information to workers to improve services

F. General Provisions

1. Conflicts of Interest in the Administration of Federal Awards or Subaward

Recipients and pass-through entities must disclose, in writing, any real or potential conflicts of interest that may arise during the administration of the Federal award, as defined by the Federal or SLTT statutes or regulations or their own existing policies, to the FEMA Specialist and SAMHSA Program Officer within 15 days of learning of the conflict of interest. Additionally, to eliminate and reduce the impact of conflicts of interest in the subaward process, recipients and pass-through entities must follow their own policies and procedures regarding the elimination or reduction of conflicts of interest when making subawards. Recipients and pass-through entities are also required to follow any applicable Federal and SLTT statutes or regulations governing conflicts of interest in the making of subawards.

Similarly, sub-recipients, whether acting as subrecipients or pass-through entities, must also disclose any real or potential conflict of interest to the pass-through entity as required by the pass-through entity's conflict of interest policies, or any applicable Federal or STT government statutes or regulations.

Conflicts of interest may arise during the process of FEMA and SAMHSA making a Federal award in situations where an employee, officer, or agent, any members of their immediate family, or their partner has a close personal relationship, a business relationship, or a professional relationship with an STT government provider entity, recipient, subrecipient, or FEMA employee.

2. Mandatory Disclosures

All violations of Federal criminal law involving fraud, bribery, or gratuity violations potentially affecting the Federal award must be submitted in writing to the FEMA Specialist and SAMHSA Program Officer at the time of the application, or if the violation occurs after the time of application, no later than 15 days after confirmation that such a violation occurred.²¹⁸

G. Modifications to Budget and Program Plans

The STT government is required to report deviations from the approved budget or project scope and request prior approval from the SAMHSA Project Officer and FEMA Specialist for budget and program plan revisions, in accordance with 2 C.F.R. § 200.308. The STT government must request prior approval for the following:

- Change in scope or the objective of the project or program.
- Change in key personnel specified in the application or Federal award.
- The disengagement from the project for more than three months, or 25% reduction in time devoted to the project, by the approved project director or principal investigator.
- Unless described in the application and funded in the approved Federal award, the sub-awarding, transferring, or contracting out of any work under a Federal award. This provision does not apply to the acquisition of supplies, material, equipment, or general support services.
- Incurrence of project costs 90 calendar days before the Federal awarding agency makes the Federal award. The Federal awarding agency is under no obligation to reimburse such costs if for any reason the STT government does not receive a Federal award or if the Federal award is less than anticipated and inadequate to cover such costs. (See also section on pre-award costs.)

The Federal awarding agency may, at its option, restrict the transfer of funds among direct cost categories or programs, functions, and activities for Federal awards in which the Federal share of the project exceeds the Simplified Acquisition Threshold and the cumulative amount of such transfers exceeds or is expected to exceed 10% of the total budget as last approved by the Federal awarding agency.

Changes to the program plan based on the evolving needs assessment may require that funding be moved from one line item to another or from one provider to another. The STT government has the authority to move funds, up to a cumulative 10% of the total budget, from one line item to another without requesting approval.

Any budget adjustments that move a cumulative 11–25% of funds must be submitted in writing and approved by the FEMA Specialist, in collaboration with the SAMHSA Project Officer. Any budget adjustments that exceed a cumulative 25% of the total budget must be submitted in writing and approved by FEMA and the SAMHSA Project Officer and Grants Management Officer.

Budget adjustments or modifications should be discussed with FEMA Specialist and SAMHSA Project Officer prior to submitting a request for additional funds. Use a Request for Budget Adjustment letter template available online at CCP Toolkit.

The FEMA RA, in coordination with the SAMHSA Project Officer, is responsible for providing technical assistance to the STT government regarding budget adjustments. The RA approves any budget adjustment requests for the ISP or those up to 25% for the RSP. If the requested budget adjustment for an RSP exceeds 25%, the responsibility for approval belongs to the SAMHSA Grants Management Officer.

H. Appeals

1. Appealing a Denial Determination

A Federal award applicant may appeal FEMA's decision. This appeal must be submitted to the FEMA Individual Assistance Division Director (IADD), in writing, within 60 days of the date of the application decision.²¹⁹ The appeal must include additional information justifying a reversal of the previous decision. The FEMA IADD shall review the material submitted, and after consultation with SAMHSA, notify the applicant within 15 days, in writing, of their decision.

2. Appeals of Remedies for Noncompliance

The STT government may submit a written appeal letter (including supporting documentation), signed by the Governor, GAR, or Tribal Chief Executive, to the appropriate FEMA RA and SAMHSA within 15 days of the date of notification of the remedial action. The FEMA RA, after consultation with SAMHSA and FEMA HQ, will make an appeal determination within 15 days, in writing to the applicant.

3. Objections/Appeals of Decisions Regarding Allowable Costs

The STT government may submit a written appeal letter (including supporting documentation), signed by the Governor, GAR, or Tribal Chief Executive, to the FEMA RA and SAMHSA within 15 days of the date of notification of the disallowed cost. The FEMA RA, after consultation with SAMHSA and FEMA HQ, will make an appeal determination within 15 days, in writing to the applicant.

4. Objections/Appeals of Termination or Suspension

The STT government may submit a written appeal letter (including supporting documentation), signed by the Governor, GAR, or Tribal Chief Executive, to the FEMA RA and SAMHSA within 15 days of the date of notification of the suspension or termination action. The FEMA RA, after consultation with SAMHSA and FEMA HQ, will make an appeal determination within 15 days, in writing to the applicant.

I. Procurement Requirements under a Federal Award

Federal award recipients shall ensure that the process of soliciting CCP services is fair and transparent. Recipients must follow the same policies and procedures when procuring property and services under a Federal award that they follow for procurement from non-Federal funds. Recipients must ensure that any contract provisions as required by 2 C.F.R. § 200.326 *Contract provisions* are included on all purchase orders or contracts that draw from Federal funds. All other recipients, including subrecipients of an STT government will follow the *General procurement standards* as required by 2 C.F.R. § 200.318 through § 200.326.

Chapter 6: Disaster Legal Services

I. Overview

When the President declares a major disaster that is approved for Individual Assistance (IA), FEMA, through an agreement with the Young Lawyers Division (YLD) of the American Bar Association, provides free legal help for survivors of that disaster through a request from the state, local, territorial, or tribal (SLTT) government. Disaster Legal Services (DLS) provides confidential legal assistance to low-income individuals who are unable to secure legal services to meet their unmet disaster-caused needs without a cost-share.

A. Period of Assistance

DLS can be authorized immediately following the IA declaration and continue until FEMA, in coordination with the legal representatives and the state, territorial, or tribal (STT) government determine that the hotline and services are no longer needed.

B. Types of Assistance

DLS is limited to cases that will not generate a fee for the survivor. Typically, local lawyers provide the following types of disaster legal services:

- Help with insurance claims for doctors and hospital bills, loss of property, loss of life, etc.;
- Drawing up new wills and other legal papers lost in the disaster;
- Estate administration, including guardianships and conservatorships;
- Consumer protection matters, remedies, and procedures;
- Help with home repair contracts and contractors;
- Counseling and advice about landlords/tenants;
- Preparing power of attorney and guardianship materials; and
- FEMA appeals and other disaster-related actions against the government.



Fee-Generating Case

For the purposes of this section, a fee-generating case is one which would not ordinarily be rejected by local lawyers as a result of its lack of potential remunerative value.



A Legal Aid representative helps a resident at a Disaster Recovery Center (DRC).

DLS must be accessible to people regardless of race, color, national origin, sex, age, disability, English proficiency, or economic status. In particular, providers of DLS must plan to meet the needs of people with limited English proficiency and people with disabilities, such as people who are deaf or hard of hearing who may use sign language or captioning.

DLS cases that may generate a fee (such as lawsuits) are not covered by this service and may be referred to private lawyers through existing lawyer referral services in the affected area. It is important to note that DLS provides legal advice and not cash assistance.

C. Authorities

The FEMA DLS program is authorized under Section 415²²⁰ of the Stafford Act and implementing regulations found in 44 C.F.R. § 206.164.

D. Partner Organizations

FEMA partners with the YLD of the American Bar Association to provide DLS through a memorandum of agreement. YLD coordinates with participating attorneys, law firms, nonprofit legal services providers, Legal Services Corporation recipients, state and local bar associations, and pro bono organizations to provide legal assistance under the DLS Program. The disaster operation will pay for representatives from the American Bar Association overseeing the DLS program to travel to the disaster (FEMA JFO, DRC, etc.) to review and audit the program in progress at least once during the period of performance (POP) for that specific program.

E. Conditions of Eligibility

An individual is eligible for disaster legal services if they were directly affected by a Presidentially-declared disaster, meet the definition of low-income, and do not have the means to hire an attorney.

1. Definition of low-income

For the purpose of defining eligibility for Disaster Legal Services assistance, low-income is used to refer to those disaster survivors who have insufficient resources to secure adequate legal services, whether the insufficiency existed prior to or resulted from the major disaster.



Tools and Resources

For more information, an individual may visit the American Bar Association's website at:

- American Bar Association Committee on Disaster Response and Preparedness
- Disaster Legal Services Program

An individual may also visit their local FEMA Disaster Recovery Center (DRC) for further referral information.

II. Delivery of Services

Once FEMA has authorized the DLS program, the ABA YLD will establish a local toll-free hotline to receive calls and provide free legal assistance services. In addition to the local hotline, individuals can visit FEMA Disaster Recovery Centers (DRCs) where DLS representatives may be located. Attorneys seeking to volunteer their time can visit the YLD's Disaster Relief Portal at <https://aba.joinpaladin.com/aba-disaster-relief/>, where they can seek local or national opportunities to assist low income disaster survivors.

A. Program Approval Process

The impacted STT government can request the DLS program through the Request for Presidential Disaster Declaration (FEMA Form 010-0-13).

For individuals seeking DLS, there is no formal application process. Individuals can access these services by contacting the toll-free number established once the program has been authorized.

This page is intentionally blank.

Chapter 7: Disaster Unemployment Assistance^{iv}

I. Overview

The Disaster Unemployment Assistance (DUA) program may be available to STT governments to provide temporary benefits to individuals whose employment or self-employment has been lost or interrupted as a direct result of a major disaster and who are not eligible for regular unemployment insurance (UI). DUA is available when the President declares a major disaster and Individual Assistance (IA) is approved. Individuals may also receive re-employment services administered by the STT government; there is no cost share.

The DUA program is authorized under Section 410 of the Stafford Act. The U.S. Department of Labor²²¹ oversees the DUA program and coordinates with the Federal Emergency Management Agency (FEMA). DUA is administered by the respective state or territory UI agency acting as agents of the Federal Government. When DUA is approved under a direct tribal declaration, the program is administered through the state UI of the state in which the tribal headquarters is located. FEMA provides the funding for DUA payments and state administrative costs. DUA payments are made by the respective state or territory UI agencies, under agreements with the Secretary of Labor, to eligible individuals unemployed as a direct result of the disaster. The Department of Labor implementing regulations for DUA are found at 20 C.F.R. § 625. More information is available in the current [UI DUA Handbook](#).

A. Period of Assistance

DUA benefits are generally paid for up to 26 weeks beginning with the first week following the date the major disaster began, and ending with the 26th week following the date the major disaster is declared by the President. DUA will not be paid for any period of unemployment that occurs prior to the date of the start of the incident period nor for any period of unemployment which begins subsequent to the end of the disaster assistance period.



FEMA employee discusses how to file a claim for disaster unemployment.

B. Types of Assistance

DUA provides temporary financial assistance and reemployment services to eligible individuals. The weekly DUA benefit amount will be based on the gross wages of the individual. If the individual is self-employed, the weekly benefit amount will be based on the net earnings (income) from self-employment. Generally, benefits are calculated using the same formula used for state UI benefits. However, the minimum weekly benefit amount payable can be no less than half (50%) of the average UI benefit amount in the state,²²² with certain exceptions for part-time workers.

C. Application Process

Individuals seeking DUA must file a claim within 30 days of the public announcement of the availability of DUA in the STT government. Individuals must follow the instructions in the announcement and apply for DUA based on the filing method used by the respective state or territory UI agency (i.e., in person, online, or by mail or telephone).

^{iv} OMB revised the regulations that govern federal grants and cooperative agreements, please refer to Title 2 of the Code of Federal Regulations for more details. See [Electronic Code of Federal Regulations](#).

Individuals who moved or evacuated to another STT government should contact the affected STT government for claim filing instructions. Individuals can also contact the respective state or territory UI agency in the state or territory where they are currently residing for claim filing assistance.

Individuals are required to substantiate employment or self-employment or to substantiate work that was to begin on or after the first day of the incident period for the disaster. If proof of employment cannot be provided at the time the claim is filed, individuals have 21 calendar days from that time to meet this requirement.²²³ Failure to submit this documentation within the 21 days will result in a denial of DUA, and any benefits already paid will be considered overpaid. Individuals are required to repay any benefits overpaid. Individuals are also required to submit proof of wages or income within 21 days of filing the DUA claim.

The RA may approve or deny requests for funding to support the DUA program in coordination with the U.S. Department of Labor.

The state or territory workforce agency will submit the funding request to the RA through the Regional Department of Labor; the tribal government will work with the state workforce agency to submit the funding request in the same way. The program may be funded for up to 26 weeks of benefits and subsequent administrative costs if:

- A complete state workforce agency funding request and Regional Department of Labor recommendation is received;
- The funding amount request provides reasonable justification for the key assumptions leading to the cost estimate; and
- There is sufficient explanation for unusually high cost estimates, to include administrative costs exceeding 15%.

If approved, the RA must submit a written approval with justification to the U.S. Department of Labor Comptroller for processing of the funds to the state or territory workforce agency.

If denied, the RA must submit a written denial with justification to the state or territory workforce agency.

D. Congressional Notification Process

Department of Homeland Security Appropriations Act, Sec. 507, requires FEMA to notify the Congressional Appropriations Committee at least three full business days in advance of making or awarding a grant allocation, grant, contract, or other transaction agreement exceeding \$1,000,000. This process may add weeks to the timeline before obligating the Federal award.



Tools and Resources

For additional information concerning the DUA program, individuals may contact the U.S. Department of Labor at:

Website:

<https://workforcesecurity.doleta.gov/>

Phone: 866-487-2365

An individual may also contact their state UI agency for state-specific information:

Website: <https://www.careeronestop.org/>

Phone: 877-872-5627

E. Conditions of Eligibility

1. General Requirements

These general conditions must be met for an applicant to be eligible for DUA. Requested documents to establish the proof of these conditions may vary by state or territory. A disaster survivor must:

- Provide proof of identity;
- Be a U.S. citizen, non-citizen national, or qualified alien;
- Be ineligible for regular UI;
- Be unemployed or partially unemployed as a direct result of the major disaster;
- Be able and available for work, unless injured as a direct result of the disaster;
- File an application for DUA within 30 days of the date of the public announcement of availability of DUA; and
- Have not refused an offer of employment in a suitable position.

2. Conditions of Unemployment

In addition to general requirements to receive DUA, an individual must meet one of several conditions of unemployment or inability to perform services in self-employment as a direct result of the disaster. Requested documents to establish the proof of these conditions may vary by state or territory. These conditions are:²²⁴

- The individual has had a week of unemployment following the date the major disaster began;
- The individual is unable to reach their place of employment;
- The individual was scheduled to start work and the job no longer exists or the individual was unable to reach the job;
- The individual became the major support of the household because the head of the household died as a direct result of the disaster; or
- The individual cannot work because of an injury caused as a direct result of the major disaster

3. Frequency of Filed Claims

The individual must continue to file weekly or biweekly claims for DUA benefits according to the instructions given by the state or territory agency when the DUA application is filed.



How to File a Claim

To file a claim, individuals who are unemployed as a direct result of the disaster should contact their state or territory UI agency

Website: <https://www.careeronestop.org/>

II. Delivery of Services

After the President declares a major disaster, the affected STT government can apply for funding for the DUA program. DUA is administered by the state or territory UI agency, which issues a public announcement throughout the declared disaster area notifying individuals in the affected area at the time of the disaster that they may be eligible for DUA compensation if they apply within the 30-day application period starting on the first public announcement date for the designated area. Under a direct tribal declaration, this public announcement would be issued by the state or territory workforce agency in conjunction with the tribal government. If the Presidential disaster declaration is later amended to include additional areas, another release should be prepared that allows for a separate 30-day application period for affected employment in the newly designated areas.

Chapter 8: Voluntary Agency Coordination

I. Overview

Voluntary agencies are the first and the last organizations to provide survivor support services in a community before and after a disaster. Agencies in the community begin providing services prior to a disaster and continue throughout the long-term recovery period after a disaster. The FEMA Voluntary Agency Coordination Section provides technical assistance, coordination and subject matter expertise to partners who are addressing gaps in resources, providing financial support and additional support to survivors after government assistance is exhausted. This assistance is provided through FEMA's Voluntary Agency Liaison (VAL) staff.

A. Voluntary Agency Coordination

The mission of FEMA VALs is to establish, foster, and maintain relationships among government, voluntary, faith-based, and community partners. Through these relationships, the VALs support the delivery of inclusive and equitable services and empower and strengthen capabilities of communities to address disaster-caused unmet needs.

A function of the VAL staff is the coordination of voluntary activities between internal FEMA partners, local, state and federal government entities and state and National VOAD.

FEMA VALs work with state VALs and voluntary agencies at all levels. Some examples of voluntary agencies supported by VALs include: National VOAD, state VOADs, Domestic Hunger Relief Organizations, Long-Term Recovery Groups, and other NGOs in local communities.

During disaster operations, VALs provide additional support by organizing and building the capability of disaster recovery for current and future disasters.²²⁵ Additionally, FEMA VALs continue to support ongoing community recovery activities even after the period of assistance has ended.



The Calvary Chapel Relief volunteers, an organization, works tirelessly to remove damaged boards from the Asbury Park boardwalk after Hurricane Sandy.

II. Responsibilities of FEMA Voluntary Agency Liaisons

The VALs provide expertise to FEMA offices concerning the voluntary agency sector's participation in prevention, protection, response, recovery, and mitigation. The VALs also keep the Voluntary Organizations Active in Disaster and other partners informed about programs, policies, trends, reports, services and plans. Additionally, VALs host and attend quarterly meetings, provide trainings and briefings with primary responsible voluntary agencies, community-based and faith-based organizations, and the private sector organizations independent from state and local VOADs. Some of the FEMA VAL activities may include:

A. National Response Coordination Center

The FEMA National Response Coordination Center (NRCC) is a resource the Federal Government employs to bring multi-agency resources, both government and NGO, together during major disasters. VALs in the NRCC, as well as the RRCCs, support the Regions and coordinate with voluntary organizations to identify gaps in services to survivors and communicate available resources to meet them. Resources may also include donated goods.

B. Non-Declared Disasters

FEMA VALs may provide support to communities that do not receive a Presidential disaster declaration. This shifts more duties to voluntary agencies without the Individual Assistance structure administered by FEMA and public support often engendered by a Presidential disaster declaration. In these instances, the complex challenge of survivor recovery is addressed by voluntary agencies working to assist in the impacted areas. VALs may provide subject matter expertise to an STT government to help coordinate agencies and improve service delivery. VALs may also be called upon to help conduct a preliminary damage assessment, prior to a declaration, to gauge the level of voluntary agency activity, as well as support the development of long-term recovery efforts. VALs may also be requested to support non-Stafford Act events where subject matter expertise for community convening, volunteer and donations management, and other emergency management functions assist other Federal agencies, international incidences, and private sector disaster activities.

C. Emergency Declarations and Public Assistance

VALs may be requested to assist during emergency declarations and major disaster declarations that have only been approved for Public Assistance (PA). While FEMA PA programs are focused on infrastructure repair, there may be individual households impacted by the disaster that will not receive government disaster assistance. VALs work with the community to develop voluntary agency capacity to provide assistance to impacted survivors. Examples of these types of activities can be seen in *Figure 43*.

Figure 43: VAL Coordination during Non-Declared Emergencies and PA-Only Declarations				
Operation	Month/Year	Location	Declaration Type	Activities
Miwok Tribe Structure Fire Tribal Headquarters destroyed	April 2015	CA	N/A	Provided volunteer coordination, technical assistance, and information for philanthropic grant opportunities.
Okanogan, WA Floods/Wildfires	August 2014	WA	PA	Assisted in developing Long-Term Recovery Groups, identified recovery resources for disaster survivors, and coordinated assistance efforts among government and NGO service providers.
West Virginia Flood Recovery	April 2015	WV	PA	Coordinated Bridge Committee resources and assisted with developing pilot program for bridge construction by Voluntary Agencies.

D. Volunteer and Donations Management

Individuals and organizations often donate resources to SLTT governments to assist with response and recovery. A donated resource may be in the form of materials, equipment, financial contributions, services or supplies. In an effort to efficiently manage the donated goods and services to SLTT governments, or voluntary agencies, FEMA VALs may provide logistical support by coordinating donations and working with the state to develop warehouse solutions. The *Volunteer and Donations Management Support Annex to the National Response Framework* describes the coordination process of unaffiliated volunteers, unaffiliated organizations, and unsolicited donated goods.²²⁶

FEMA provides assistance through:

- Volunteer and donations management training;
- Volunteer and donations messaging; and
- Technical assistance on volunteer and donations management.

Donations management training is provided through the Emergency Management Institute (EMI), for Federal, SLTT government, nonprofit and private sector partners. Additional trainings are delivered through Independent Study, attendance at a classroom offering at the National Emergency Training Center (NETC), or through a field-based classroom offering at a FEMA Joint Field Office (JFO) which can be accessed at the FEMA Emergency Management Institute website.

FEMA donations messaging regarding the appropriate method for the public to donate can be found at the *FEMA Volunteer and Donate Responsibly* website. Financial contributions are the most efficient method of donating. Funds allow the most flexibility in obtaining the needed resources, at the correct time and moves money into the local economy to help businesses recover. The site also provides information on accepted methods for unaffiliated volunteers to get connected.

More information and technical assistance on volunteer and donations management may be found through the following resources:

- National Voluntary Organizations Active in Disaster;
- National Association of State Emergency Volunteer and Donations Coordinators (NASEDoVoC);
- The American Logistics Aid Network (ALAN); and
- FEMA also uses the International Assistance System (IAS) Concept of Operations as the mechanism to accept/reject offers of donations from countries outside the United States of America.

Appendix A: Section 425 Transportation Assistance

Section 425 of the Stafford Act authorizes FEMA to provide assistance to relocate individuals displaced from their pre-disaster primary residences as a result of a major disaster or emergency or otherwise transported from their pre-disaster primary residence under Section 403(a)(3) or Section 502 of the Stafford Act, to and from alternative locations for short or long-term accommodation or to return an individual or household to their pre-disaster primary residence or alternative location.

I. Authorizing Section 425 Transportation Assistance

FEMA's AA for Recovery has the authority to approve Section 425 Transportation Assistance at the request of the affected STT government. This form of assistance may be considered for specific areas within the declared disaster when:

- The scale and magnitude of the declared incident results in an extended displacement of disaster survivors;
- Temporary housing options within a reasonable distance from the disaster area are limited; and
- A concurrent lack of infrastructure exists within the affected area.

A. Conditions of Eligibility

Section 425 Transportation Assistance does not count toward an applicant's financial Housing Assistance maximum award or the Other Needs Assistance maximum award. To be considered for Section 425 Transportation Assistance, the applicant must:

- Register for FEMA assistance within the registration period;
- Confirm their pre-disaster primary residence is in the declared disaster area;
- Be significantly displaced from their pre-disaster residence due to the disaster, factoring in distance to include travel time and mileage;
- Be able to secure temporary housing (excluding hotels/motels) in the alternative location;
- Pass identity verification;
- Pass citizenship requirements; and
- Not have assistance available for transportation expenses from any other source.

All household members who will travel under Section 425 Transportation Assistance must be listed on the FEMA application.²²⁷ Applicants may call FEMA to add pre-disaster household members to the application if they were not listed at the time of registration.

B. Eligible Expenses

Eligible expenses may include expenses for:

- Domestic airfare, via commercial flight, at the equivalent of economy/coach class; however, FEMA may approve increased airfare costs for seat upgrades, when necessary, to accommodate household member(s) with an access or functional need.
 - Individuals and households are eligible for one round trip for all pre-disaster household members and HPSA.
 - Individuals and households who have already evacuated, whether by assistance from FEMA or of their own accord, may be eligible for a one-way return trip, for all household members and HPSA.
- Passenger baggage fees up to \$100 per pre-disaster household member.
- Transporting HPSA that may be transported via a commercial airline.
 - Interstate requirements pertaining to inbound animal clearances and all costs not included in the standard airfare cost of transporting animals will be the responsibility of the passenger.

C. Limitations and Exclusions

- Travel for unaccompanied minors is not an eligible expense. Minors must travel with at least one adult household member.
- The maximum time limit for Section 425 Transportation Assistance is the period of assistance for the IHP. FEMA may further limit the timeframe of availability for Section 425 Transportation Assistance for specific populations of applicants based on the progress of their permanent housing plan.
- Section 425 Transportation Assistance is limited to relocation to U.S. states, territories, and possessions; no international destinations will be included.
- Meals, ground transportation, and additional costs for the applicant, household, or HPSA beyond the cost of the flight are not eligible costs under Transportation Assistance.
- Travelers must have a government-issued photo ID in order to clear Transportation Security Administration airline security. The household is responsible for establishing and maintaining required travel documents.
 - It is the responsibility of travelers to ensure they have all necessary travel documentation and identification required. Travelers may also be required to have an available credit card for baggage fees.
- Section 425 Transportation Assistance is limited to travel arranged under this policy; applicants are not eligible for reimbursement of expenses for travel that has already occurred or is booked outside of this program.
- Costs for reasonable accommodations, baggage, and travel of pets and service animals must be identified when airfare is booked. Additional travel expenses incurred at the time of travel are not eligible for reimbursement.

Appendix B: Individual Assistance Program and Assistance Approvals

Not all Individual Assistance programs and types of assistance are automatically implemented when a disaster is declared for Individual Assistance.

When requested by the STT government, FEMA officials at various levels throughout the Agency may approve the below Individual Assistance programs and types of assistance.

Figure 44 outlines who may approve each program or type of assistance: the Assistant Administrator for Recovery, the Individual Assistance Division Director, the Regional Administrator (RA), or the Federal Coordinating Officer (FCO).

FEMA RAs may further delegate some approval authority to Federal Coordinating Officers, with the exception of Transitional Sheltering Assistance, Crisis Counseling Program, Disaster Case Management, and Disaster Unemployment Assistance.

Figure 44: Delegation of IA Authorities			
Program Area	Recovery AA	IADD	RA
Mass Care and Community Services			
Transitional Sheltering Assistance			
- Initial Approval		X	
- Extensions *FCO may approve individual case exceptions			X
Crisis Counseling Assistance and Training Program—Regular Services Program			
- Initial Approval			X
- Approval Appeals		X	
Crisis Counseling Assistance and Training Program—Immediate Services Program			
- Initial Approval			X (or DRM)
- Approval Appeals			X
- Second Appeals		X	
- Policy Waivers		X	
- Extensions			X (or DRM)
Disaster Case Management			
- Initial Approval *FCO approves Immediate Disaster Case Management			X
- Approval Appeals		X	
- Extensions			X
- Extension Appeals		X	

Figure 44: Delegation of IA Authorities			
Program Area	Recovery AA	IADD	RA
Disaster Unemployment Assistance			
- Initial Approval			X
- Appeals		X	
IAPPG Policy Waivers		X	
Individuals and Households Program			
18-Month Period of Assistance Extension	X		
Registration Period			
- Extensions up to 60 days			X
- Additional extensions past 60 days		X	
Section 425 Transportation Assistance	X		
Geospatial Inspections		X	
FMR Rental Assistance Rate Increase			
- Up to 125%			X
- More than 125%		X	
ONA Administrative Option Selection Form and State Administrative Plan			X
Critical Needs Assistance		X	
Clean and Removal Assistance			X
Direct Temporary Housing Assistance	X		
Forms of Direct Housing (includes TTHU/MLR)			X
Direct Lease	X		

Figure 44: Delegation of IA Authorities			
Program Area	Recovery AA	IADD	RA
Direct Lease FMR Increase			
- Up to 200%			X
- More than 200%		X	
Multi-Family Lease and Repair FMR Increase	FMR will be consistent with Rental Assistance Rate Increase approvals		
MHU/RV Group Sites			X
Permanent Housing Construction	X		
Disposal of MHUs/RVs via Sales/Donations			X

Appendix C: Individual Assistance Policy Supersession

These policies have been superseded by IAPPG 1.1:

Figure 45: Individual Assistance Policy Supersession	
Document Number	Document Name
FP 104-009-03	Individual Assistance Program and Policy Guide – March 2019
	Policy Changes to the Individuals and Households Program resulting from the Disaster Recovery Reform Act of 2018, Section 1212 – March 2019

Appendix D: Federal Civil Rights Authorities Applicable to Recipients of Federal Financial Assistance

All recipients of Federal financial assistance, including but not limited to non-Federal entities such as SLTT government and their subrecipients, and providers of disaster-related assistance must abide by the nondiscrimination provisions in Section 308 of the Stafford Act stating the provision of disaster-related assistance shall be accomplished in an equitable and impartial manner, without discrimination on the grounds of race, color, religion, nationality, sex, age, disability, English proficiency, or economic status.

Recipients of Federal financial assistance must also comply with other Federal civil rights laws and regulations.²²⁸ Specifically, the recipient is required to provide assurances about compliance with Federal civil rights laws and regulations as a condition for receipt of Federal funds.

The FEMA-State/Territory/Tribe Agreement contains a link to the [DHS Standard Terms and Conditions](#).

Among the provisions within the DHS Standard Terms and Conditions for grants, cooperative agreements, fixed amount awards, and other types of Federal financial assistance are the following civil rights-related obligations:

Recipients of Federal financial assistance from DHS must complete the DHS Civil Rights Evaluation Tool within thirty days of receipt of the Notice of Award or, for State Administering Agencies, thirty days from receipt of the DHS Civil Rights Evaluation Tool from DHS or its awarding component agency. Recipients are required to provide this information once every two years, not every time an award is made. After the initial submission, recipients are only required to submit updates. Recipients should submit the completed tool, including supporting materials to CivilRightsEvaluation@hq.dhs.gov. This tool clarifies the civil rights obligations and related reporting requirements contained in the DHS Standard Terms and Conditions. Subrecipients are not required to complete and submit this tool to DHS. The evaluation tool can be found at <https://www.dhs.gov/evaluation-tool>.

Age Discrimination Act of 1975: Recipients must comply with the requirements of the Age Discrimination Act of 1975 (Title 42 U.S.C. § 6101 et seq.), which prohibits discrimination on the basis of age in any program or activity receiving Federal financial assistance.

Americans with Disabilities Act of 1990: Recipients must comply with the requirements of Titles I, II, and III of the Americans with Disabilities Act, which prohibit recipients from discriminating on the basis of disability in employment, the operation of public entities, public and private transportation systems, places of public accommodation, and certain testing entities. (42 U.S.C. § 12101–12213).

Title VI of the Civil Rights Act of 1964: Recipients must comply with the requirements of Title VI of the Civil Rights Act of 1964 (42 U.S.C. § 2000d et seq.), which provides that no person in the United States will, on the grounds of race, color, or national origin, be excluded from participation in, be denied the benefits of, or be subjected to discrimination under any program or activity receiving Federal financial assistance. DHS implementing regulations for the Act are found at 6 C.F.R. § 21 and 44 C.F.R. § 7.

Limited English proficiency (LEP) (Title VI of the Civil Rights Act of 1964): Recipients must comply with the Title VI of the Civil Rights Act of 1964 (42 U.S.C. § 2000d et seq.) prohibition against discrimination on the basis of national origin, which requires that recipients of Federal financial assistance take reasonable steps to provide meaningful access to persons with LEP to their programs and services. For additional assistance and information regarding language access obligations, please refer to the DHS Recipient Guidance <https://www.dhs.gov/meaningful-access> and additional resources on <http://www.lep.gov>.

Title VIII of the Civil Rights Act of 1968: Recipients must comply with the requirements of Title VIII of the Civil Rights Act of 1968, which prohibits recipients from discriminating in the sale, rental, financing, and advertising of dwellings, or in the provision of services in connection therewith, on the basis of race, color, national origin, religion, disability, familial status, and sex²²⁹, as implemented by the Department of Housing and Urban Development at 24 C.F.R. § 100. The prohibition on disability discrimination includes the requirement that new multifamily housing with four or more dwelling units—i.e., the public and common use areas and individual apartment units (all units in buildings with elevators and ground-floor units in buildings without elevators)—be designed and constructed with certain accessible features.²³⁰

Title IX of the Education Amendments of 1972 (Equal Opportunity in Education Act): Recipients must comply with the requirements of Title IX of the Education Amendments of 1972 (20 U.S.C. § 1681 et seq.), which provide that no person in the United States will, on the basis of sex, be excluded from participation in, be denied the benefits of, or be subjected to discrimination under any educational program or activity receiving Federal financial assistance. DHS implementing regulations are codified at 6 C.F.R. § 17 and 44 C.F.R. § 19.

Section 504 of the Rehabilitation Act of 1973: Recipients must comply with the requirements of Section 504 of the Rehabilitation Act of 1973, (29 U.S.C. § 794), as amended, which provides that no otherwise qualified individual with a disability in the United States will, solely by reason of the disability, be excluded from participation in, be denied the benefits of, or be subjected to discrimination under any program or activity receiving Federal financial assistance.

In addition, the United States has the right to seek judicial enforcement of these obligations.

Members of the public have the right to file a civil rights complaint if they believe they have been discriminated against by a recipient of Federal financial assistance. Please contact FEMA's Office of Equal Rights for more information: (202) 212-3535 or FEMA-CivilRightsOffice@fema.dhs.gov.

Appendix E: DCM - Allowable and Unallowable Costs

Figure 46: DCM—Allowable and Unallowable Costs		
Budget Category	Allowable Expenses	Unallowable Expenses
Personnel	<p>Salaries and wages for DCM Positions must be justified. Below is a list of some of the positions DCM allows:</p> <ul style="list-style-type: none"> • Program Director • Finance Director • Finance Manager • Administrative Assistant • Monitoring/Data Management • Data Entry Specialist • Construction Cost Analyst • Case Management Supervisor • Case Manager 	Supplanting of existing non-Federal entity or provider positions
Fringe Benefits	Fringe benefit costs at the usual and customary fringe benefit rate for SLTT providers	Fringe benefit costs above the customary fringe benefit rate for temporary SLTT provider staff
Travel	<ul style="list-style-type: none"> • Mileage reimbursement for Case Managers travel to and from disaster survivor locations or trainings if provided outside of the base office location • All travel costs must be in accordance with non-Federal entity travel policy Guidelines 	<ul style="list-style-type: none"> • Providing transportation for survivors • Out-of-state travel for DCM personnel except in exceptional circumstances with prior FEMA approval • Rental or leasing of vehicles
Equipment	<p>Equipment means an article of nonexpendable, tangible personal property having a useful life of more than one year and an acquisition cost which equals or exceeds the lesser of the capitalization level established by the governmental unit for financial statement purposes, or \$5,000.</p> <p>Pre-approval for equipment is required by FEMA</p>	N/A

Appendix E: DCM – Allowable and Unallowable Costs

Budget Category	Allowable Expenses	Unallowable Expenses
Contractual	Contracted consulted maximum FEMA reimbursement rate is \$750 per day, which includes equipment, supplies, lodging, and travel costs	Consultant costs exceeding \$750 a day
Supplies	<ul style="list-style-type: none"> • Supplies include materials that are expendable/consumed during the course of the project and less than \$5000 • Basic office equipment, such as computers, mobile phones, printers/copiers, etc. 	<ul style="list-style-type: none"> • Food and beverages • Refreshments for meetings/trainings • Video cameras, video recording equipment, televisions, and other types of video production equipment • Supplies or swag given to survivors other than training or disaster case management support documentation
Other	<p>The budget may identify costs that are unique to the declared disaster area, but do not fall into one of the budget sub-categories. Note: Costs must not be identified as miscellaneous (i.e., they must be described in detail).</p> <ul style="list-style-type: none"> • Advertising costs associated with the recruitment of personnel required for the DCM program • Rental office space • Telephone and utility costs directly billed to the DCM Program • Background checks for case managers • FEMA will pay licensing fee for technology platform • Hotline and/or call center utilized for resource collection and/or referral services may be considered with sufficient justification 	<ul style="list-style-type: none"> • Direct financial assistance for survivors • Telephone and utility charges not directly related to the DCM program • FEMA will not provide funding for a media campaign
Indirect Costs	N/A	Indirect costs, including management costs, are defined as costs not directly chargeable to a specific project. Section 324 of the Stafford Act requires FEMA to establish management cost rates in program regulations. Since DCM does not have regulations under 44 C.F.R., they are unallowable per statute

Appendix F: CCP – Allowable and Unallowable Costs

Figure 47: CCP—Allowable and Unallowable Costs			
Budget Category	Fundable Expenses	Non-Fundable Expenses (items apply to all budget categories)	Typical In-Kind Contributions
Salaries and Wages	<ul style="list-style-type: none"> • Salaries and wages for typical CCP positions: <ul style="list-style-type: none"> ○ Crisis Counselor ○ Team Leader (Supervisor) ○ Administrative Assistant ○ Data Evaluation Specialist ○ Consultant/Trainer (listed in personnel only if a direct SLTT or provider employee) ○ Fiscal Specialist ○ SLTT CCP Program Manager/Director ○ Provider Project Manager ○ Community Liaison/Resource Linkage Coordinator ○ Media Liaison ○ Child/Senior Care Specialist ○ Disability Specialist / Communications Access Specialist 	<ul style="list-style-type: none"> • Longer term, more formal mental health services, and mental health professionals providing these services (e.g., diagnosis and therapy) • Longer-term, more formal substance use treatment, and para professionals providing these services • Advocacy • Formal critical incident stress debriefing (CISD) services or critical incident stress management (CISM) training • Reimbursement for uncollected revenue (e.g., if mental health workers respond to the disaster and it results in fewer Medicaid billings, the state will not be reimbursed for these lost Medicaid billings) • Supplanting of existing SLTT or provider positions 	Salaries and wages of existing SLTT and local staff, such as the SLTT Disaster Behavioral Health Coordinator and local area provider agency managers who dedicate a percentage of time to the CCP in addition to their existing duties
Fringe Benefits	Fringe benefit costs at the usual and customary fringe benefit rate for SLTT and local providers	Fringe benefit costs above the customary fringe benefit rate for temporary SLTT and local provider staff	N/A

Figure 47: CCP—Allowable and Unallowable Costs			
Travel	<ul style="list-style-type: none"> Mileage reimbursement for crisis counselor travel to deliver services in survivor homes, meet with community groups or agency personnel, and conduct/receive training The standard motor-pool cost if SLTT cars are used 	<ul style="list-style-type: none"> Out-of-state/area travel for CCP personnel Transportation for survivors Rental/leasing of vehicles except in unusual circumstances that indicate personal vehicles are not a reasonable option 	The SLTT may offer to use the motor-pool as an in-kind contribution
Equipment	<p>Equipment purchases of more than \$5,000 per individual item</p> <p><i>Consult with FEMA and CMHS Project Officer prior to developing the budget for this category.</i></p>	Consult with FEMA and CMHS Project Officer for specific non- fundable expenses	N/A
Consultants / Trainers	<ul style="list-style-type: none"> CMHS-approved, qualified consultants providing technical assistance or consultation to SLTT project staff on program development and project management CMHS-approved, qualified trainers providing standardized CCP training or training concerning unique disaster-related issues (e.g., cultural competence, working with children, working with special populations) Travel costs, lodging, and per diem for consultants <p><i>For contracted consultants, the maximum FEMA reimbursement rate is \$750 per day, which includes preparation, materials, and travel time</i></p>	<ul style="list-style-type: none"> Consultants or trainers not approved by CMHS Consultant charges exceeding \$750 per day Conferences or workshops not directly related to the project Out-of-state/territory training Disaster preparedness training CISD or CISM training 	Costs and time associated with the use of SLTT in- house consultants

Figure 47: CCP—Allowable and Unallowable Costs

<p>Supplies</p>	<ul style="list-style-type: none"> • Basic office equipment, such as computers, mobile phones, printers, pagers, fax machines, or photocopiers • One phone per two crisis counselors when providing door-to-door outreach 	<ul style="list-style-type: none"> • Food and beverages • Refreshments for meetings and trainings • Medications • Toys or playground items for recreational programs • Disaster kits • Video cameras and recording equipment, televisions, and other video production equipment • Supplies or swag given to survivors other than training or crisis counseling support documentation • Using personal phones or providing stipends for personal phones to make anonymous calls • More than one smart technology device per two crisis counselors or one helpline staff unless the need is required in which to provide services • MiFis or additional hotspot devices other than phones 	<ul style="list-style-type: none"> • Use of existing equipment, such as office furniture, computers, fax machines, printers, or photocopiers • Food and beverages • Toys and recreational items
-----------------	---	---	--

Figure 47: CCP—Allowable and Unallowable Costs

<p>Media / Public Information</p>	<ul style="list-style-type: none"> • Advertisements to recruit crisis counselors • Educational materials, pamphlets, and handouts • Flyers or other materials to promote access to CCP services • Staff identification items, such as t-shirts or name badges • Media messaging and public service announcements • Staff identification items, such as t-shirts, with the STT’s CCP brand and/or name badges • Duplication of existing materials, such as FEMA and CMHS disaster behavioral health materials <p><i>Video and multimedia product development may be funded only if it is carefully justified and the following three criteria are met:</i></p> <ul style="list-style-type: none"> • No comparable resource is available from another CCP, any Federal or SLTT government agency, or any private entity • The SLTT government has provided a comprehensive description of the objectives and format of the product, and has demonstrated the disaster mental health expertise to develop a quality product • The product can be completed to be used as an educational or training tool during the CCP 	<ul style="list-style-type: none"> • Items/activities not included as part of the Federal award application program plan or not approved by the FEMA and CMHS project officers • Disaster preparedness materials • Expensive print, television, or radio advertisements • Video cameras, video recording equipment, televisions, and other types of video production equipment • Shirts, hats, and other clothing intended to be worn by CCP staff and/or any advertisement that does not have the STT’s specific CCP project brand will be considered self-promoting for the non-Federal entity and providers and is unallowable as per 2 C.F.R. § 200.421 	<p>For print advertisements and broadcast time, FEMA and CMHS advise that programs seek donations as a public service for space and airtime announcements.</p> <p>If this is not possible, list these media costs as a budget item, and provide ample justification in the narrative.</p>
-----------------------------------	--	--	---

Figure 47: CCP—Allowable and Unallowable Costs			
Provider / Contractual Costs	<ul style="list-style-type: none"> • Provider costs and any other contractual costs must be itemized. The itemization should include costs associated with salaries, fringe, travel, per diem, and training. These costs must be justified in the budget narrative. 	<ul style="list-style-type: none"> • Items or activities not included as part of the Federal award application program plan or not approved by the FEMA and CMHS Project Officers • Transportation of survivors • Mental health treatment 	<ul style="list-style-type: none"> • Office space • Additional trainings • Equipment (copiers, printers, fax) • Human resources
Other	<p><i>The budget may identify costs that are unique to the disaster and area affected but do not fall into one of the prescribed categories. Costs must not be identified as miscellaneous (i.e., they must be described in detail)</i></p> <p>Categories typically listed as Other:</p> <ul style="list-style-type: none"> • Rental Office Space <ul style="list-style-type: none"> ○ Office space for the management and administration of the program. ○ Appropriate telephone and utility costs for CCP operations when not located within existing SLTT mental health authority or provider space ○ Telephone and Utilities ○ Additional costs to conduct CCP evaluation and data collection in compliance with program guidance 	<ul style="list-style-type: none"> • Facility renovation, repair, or construction • Transportation for survivors • Child care • Case management • Diagnostic testing • Toys or recreational equipment or activities • Food and beverages • Video or multimedia recording equipment • Long-term mental health services • Financial assistance for survivors • Fundraising activities • Disaster preparedness • Facility renovation, repair, or construction • Telephone and utility charges not directly related to CCP operations • Evaluation activities outside program guidance 	<ul style="list-style-type: none"> • Office space within the SLTT government mental health authority and CCP provider facilities • Utilities such as heat, water, or electricity

Appendix G: Environmental Planning and Historic Preservation Compliance

Federal Environmental Planning and Historic Preservation (EHP) laws, regulations, and executive orders (EOs) establish requirements to protect the environment and preserve historic and cultural resources. Federally-funded IA grants and programs must comply with EHP requirements, including but not limited to the following:

National Historic Preservation Act

Section 106 of the National Historic Preservation Act requires FEMA to consider the effects a project will have on historic properties and provide the Advisory Council on Historic Preservation the opportunity to comment on the effects of the project.²³¹ Historic properties include buildings or groups of buildings (districts), structures, objects, landscapes, archaeological sites, and traditional cultural properties included in, or eligible for inclusion in, the National Register of Historic Places.²³²

National Environmental Policy Act

Section 102 of the National Environmental Policy Act (NEPA) requires Federal agencies to integrate environmental values into their decision-making processes by considering the environmental impacts of their proposed actions and reasonable alternatives to those actions. The White House Council on Environmental Quality (CEQ) publishes NEPA regulations at Title 40 of the Code of Federal Regulations Parts 1500–1508. The U.S. Department of Homeland Security (DHS) Directive 023-01 Rev 01 and the Instruction Manual 023-01-001-01 Rev 01 establish DHS policy and procedures for compliance with NEPA and CEQ regulations for implementing the procedural provisions of NEPA. FEMA’s Directive 108-1 and Instruction 108-1-1 detail FEMA’s roles, responsibilities, authorities, and procedures to ensure all FEMA’s actions comply with Federal EHP statutes and Executive orders. These documents tier off of and serve as component supplementary instructions for DHS’s Directive and Instruction. The process ensures consideration of environmental consequences of the project and informs the general public.

Endangered Species Act

Section 7 of the Endangered Species Act requires Federal agencies to use their authorities to conserve Federally-listed threatened and endangered species (listed species) and their designated critical habitat. FEMA must consult with the U.S. Fish and Wildlife Service (USFWS) and the National Oceanic and Atmospheric Administration Fisheries, also known as the National Marine Fisheries Service (NMFS) to ensure that proposed projects will not jeopardize the continued existence of any listed species or result in the destruction or adverse modification of designated critical habitat for listed species.²³³

Clean Water Act

The Clean Water Act (CWA) establishes the basic structure for regulating discharges of pollutants in the waters of the United States (e.g., rivers and streams, lakes and ponds, coastlines, wetlands, estuaries). The CWA makes it unlawful to discharge any pollutant from a specific source into navigable waters without the appropriate CWA permits from the U.S. Army Corps of

Engineers (USACE) or state regulatory agency. If a proposed project is located in one of these regulated features, FEMA must review the action for compliance with CWA and may have to consult with the USACE or state regulatory agency.²³⁴

Clean Air Act

The Clean Air Act protects the Nation's air through the reduction of smog and atmospheric pollution. Except for activities in non-attainment areas (defined as those areas that do not meet national standards for air quality and, therefore, require more rigorous compliance measures), air quality compliance often requires certain measures be implemented, such as dust abatement, vehicle emissions control, fuel storage, and distribution procedures.²³⁵

Coastal Barrier Resources Act

The Coastal Barrier Resources Act (CBRA)²³⁶ established the John H. Chafee Coastal Barrier Resources System (CBRS), which consists of relatively undeveloped coastal barriers along the Atlantic, Gulf, and Great Lakes coasts. CBRA minimizes adverse impacts to these areas by restricting Federal assistance that encourages development within the CBRS. USFWS publishes maps designating these areas.²³⁷ FEMA must consult with USFWS prior to providing IA funding for work within the CBRS, when applicable.²³⁸

Migratory Bird Treaty Act

The Migratory Bird Treaty Act makes it unlawful to pursue, hunt, take, capture, kill, or sell migratory birds listed in the statute without a take permit from USFWS.²³⁹ FEMA consults with USFWS regarding projects likely to trigger compliance with this Act.

Resource Conservation and Recovery Act

The Resource Conservation and Recovery Act (RCRA) establishes a framework for Federal, state, territorial, and local cooperation for controlling the management of hazardous and non-hazardous solid waste. The U.S. Environmental Protection Agency's (EPA's) establishes minimum regulatory standards for compliance, usually implemented by the states, and provides technical assistance. RCRA requires the safe disposal of waste materials, promotes the recycling of waste materials, and encourages cooperation with local agencies. Proposed Group Sites may require an Environmental Site Assessment to establish any potential site contamination prior to construction.²⁴⁰

Coastal Zone Management Act

The Coastal Zone Management Act (CZMA) provides for the management of the Nation's coastal resources. The CZMA establishes a voluntary partnership between the Federal Government and coastal and great lakes states and territories. It requires participating states to develop State coastal zone management plans. IA projects located in, or near, established coastal zone management areas must be consistent with the enforceable policies of the state's Federally-approved coastal zone management plan.²⁴¹ Before approving a project in a coastal zone management area, FEMA consults with the state agency overseeing the implementation of the CZMA plan to ensure the project is consistent with the plan's provisions.

Farmland Protection Policy Act

The Farmland Protection Policy Act minimizes the extent to which Federal programs contribute to the conversion of prime or unique farmland, or land of statewide or local importance, to non-agricultural uses and to ensure that Federal programs are administered in a manner that, to the extent practicable, will be compatible with state, territorial, local, and private programs and policies to protect farmland. The Farmland Protection Policy Act and U.S. Department of Agriculture (USDA) implementing procedures require FEMA to evaluate projects for adverse effects to such farmland and to consider alternative actions that could avoid adverse effects. For projects that have the potential to affect such farmland, FEMA must consult with the USDA Natural Resources Conservation Service to identify potential impacts to that farmland.²⁴²

Fish and Wildlife Coordination Act

The Fish and Wildlife Coordination Act protects fish and wildlife when Federal actions result in the control or modification of a natural stream or body of water. The Fish and Wildlife Coordination Act requires Federal agencies to determine whether a proposed action will result in the control or modification of a body of water. Projects involving the control or modification of any water body require Federal agencies to consult with USFWS and NMFS (as appropriate) and state wildlife agencies to develop measures to protect, develop, and improve fish and wildlife conditions.²⁴³

Wild and Scenic Rivers Act

The Wild and Scenic Rivers Act preserves the free-flowing state of rivers that are listed in the National Wild and Scenic Rivers System (System) or are under study for inclusion in the System because of their scenic, recreational, geologic, fish and wildlife, historic, cultural, or other similar values. If a proposed project is located on a river included in the System, FEMA must review it for compliance with the Wild and Scenic Rivers Act and consult with the managing agency for the affected designated river.²⁴⁴

Magnuson-Stevens Fishery Conservation and Management Act

The Magnuson-Stevens Fishery Conservation and Management Act is the primary law for managing and maintaining sustainable fisheries in waters of the United States. The Magnuson-Stevens Fishery Conservation and Management Act protects essential fish habitat, which includes the waters and substrate necessary to maintain healthy fisheries. FEMA must consult with NMFS when any proposed IA project could have an adverse effect on essential fish habitat.²⁴⁵

Native American Graves Protection and Repatriation Act (NAGPRA)

All Federal authorizations to carry out land use activities on Federal lands or tribal lands, including all leases and permits, must include a requirement for the holder of the authorization to notify the appropriate Federal or tribal official immediately upon the discovery of human remains, funerary objects, sacred objects, or objects of cultural patrimony.²⁴⁶

Executive Order 11988, Floodplain Management

EO 11988, Floodplain Management, requires Federal agencies to minimize or avoid activity that adversely affects floodplains. It requires Federal agencies to use a systematic decision-making process to evaluate the potential effects of projects located in, or affecting, floodplains; document each step of the process; and involve the public in the decision-making process. This process is designed to:

- Reduce flood loss risks;
- Minimize the impacts of floods on human safety, health, and welfare; and
- Restore and preserve the natural and beneficial functions of floodplains.

FEMA publishes its implementing regulations for EO 11988 at 44 Code of Federal Regulations Part 9, Floodplain Management and Protection of the Wetlands. These regulations set forth the policy, procedures, and responsibilities to implement and enforce the EO, including the decision-making process, which is referred to as the 8-step process.²⁴⁷

Executive Order 11990, Protection of Wetlands

EO 11990, Protection of Wetlands, requires Federal agencies to minimize or avoid activity that adversely affects wetlands and to encourage the preservation and enhancement of the beneficial functions of wetlands. To meet these objectives, EO 11990 requires Federal agencies to use a systematic decision-making process to evaluate the potential effects of projects in, or affecting, wetlands; document each step of the process; and involve the public in the decision-making process.

FEMA publishes its implementing regulations for EO 11990, Protection of Wetlands at 44 C.F.R. Part 9, Floodplain Management and Protection of the Wetlands. These regulations set forth the policy, procedures, and responsibilities to implement and enforce the EO, including the decision-making process, which is referred to as the 8-step process.

Executive Order 12898, Environmental Justice

EO 12898, Environmental Justice, requires Federal agencies to identify and address any disproportionately high and adverse human health or environmental effects on minority and low-income populations as a result of their actions.

Appendix H: Definitions

Terms may have different meanings when applied to other FEMA, non-Federal entity, non-governmental organizations (NGOs), or local programs.

Access and Functional Needs: Circumstances that are met for providing physical, programmatic, and effective communication access to the whole community by accommodating individual requirements through universal accessibility and/or specific actions or modifications which includes assistance, accommodation or modification for mobility, communication, transportation, safety, health maintenance, etc.; need for assistance, accommodation or modification due to any situation (temporary or permanent) that limits an individual's ability to take action in an emergency.

When physical, programmatic, and effective communication access is not universally available, individuals may require additional assistance in order to take protective measures to escape to and/or from, access either refuge and/or safety in an emergency or disaster, and/or may need other assistance, accommodations or modifications in an emergency or disaster. This is accomplished through pre-planning by emergency management, first response agencies and other stakeholders or in sheltering or other situations, from notification and evacuation, to sheltering, to return to pre-disaster level of independence.

Individuals having access and functional needs may include, but are not limited to, individuals with disabilities, older adults, and individuals with limited English proficiency, limited access to transportation, and/or limited access to financial resources to prepare for, respond to, and recover from the emergency.

Federal civil rights law and policy require nondiscrimination, including on the basis of race, color, national origin, religion, sex, age, disability, English proficiency, and economic status. Many individuals with access and functional needs are protected by these provisions.²⁴⁸

Allowable Costs: For programs administered via a contract, like DLS, allowable costs are defined in the FAR as costs that are reasonable and chargeable to the contract. (See FAR 31.201-2). Although this is a broad definition, FAR Section 31 specifically addresses many types of costs a recipient/contractor may incur.

Under a grant program, like state-administered ONA, DCM, CCP, and DUA, allowable costs as defined by 2 C.F.R. § 200.403 must be necessary, reasonable, and allocable; conform to any limitations or exclusions set forth by the applicable cost principles or the Federal award; be consistent with policies and procedures that apply uniformly to both Federally-financed and other activities of the non-Federal entity; be treated consistently as either indirect or direct costs; and be adequately documented, among other factors identified by 2 C.F.R. § 200.403.

Appeal: Applicants will have the opportunity to appeal a denial of initial program award or extension requests within 60 days of receipt of the written notice of determination. The appeal will be submitted to the IADD for review and determination.

Appeals (DUA Definition): The state workforce agency will have the opportunity to appeal a denial of initial program award or supplemental funding requests within 60 days of receipt of the written notice of determination. First level appeals will be submitted to the RA for review and determination and second level appeals will be submitted to the IADD for review and determination.

Client: A disaster survivor enrolled in a Disaster Case Management (DCM) program that is receiving case management services.

Closeout: The process by which FEMA or the pass-through entity determines that all applicable administrative actions and all required work of the Federal award have been completed and takes actions as described in 2 C.F.R. § 200.343.

Conditions of Award: The legal requirements imposed on a grant by FEMA, whether based on statute, regulation, policy, or other document referenced in the grant award, or specified by the Notice of Grant Award. It may include standard and/or special conditions, as necessary to attain the grant's objectives.²⁴⁹

Contract: A legal instrument by which an STT government purchases property or services needed to carry out the project or program under a Federal award. The term as used in this part does not include a legal instrument, even if the STT government considers it a contract, when the substance of the transaction meets the definition of a Federal award or subaward.

Congressional Notification: In compliance with Section 507 of the Appropriations Act, for all awards greater than or equal to one million dollars, the RA will be required to submit advance Congressional notification and summary of award through the External Coordination Unit, Office of the Chief Financial Officer at FEMA Headquarters.

Disaster Case Management (DCM): A time-limited process involving a partnership between a disaster case manager and a disaster survivor (also known as a "client") to develop and carry out an individualized disaster recovery plan. This partnership provides the client with a single point of contact to facilitate access to a broad range of resources. The process involves an assessment of the client's verified disaster-caused unmet needs; development of a goal-oriented plan that outlines the steps necessary to achieve recovery; organization and coordination of information on available resources that match the disaster-caused unmet needs; the monitoring of progress toward reaching the recovery plan goals; and when necessary, client advocacy.

Disaster-Caused Unmet Needs: Any un-resourced item, support, or assistance that has been assessed and verified as necessary for a survivor to recover from disaster. This may include food, clothing, shelter, first aid, emotional and spiritual care, household items, home repair, or rebuilding.

Disaster Recovery Plan: A formal, written plan developed to accomplish the recovery goals identified by the client, with support from the disaster case manager. The plan is developed following a comprehensive disaster-impact assessment conducted by the disaster case manager, in close collaboration with the client, and should be updated regularly throughout the recovery process. The Disaster Recovery Plan includes specific goals and objectives that link with the client's disaster-caused unmet needs.

Extensions and additional funding: Additional funding and/or requests for extensions to the period of performance, closeout reporting, appeal deadline, or liquidation deadline may be approved by the RA. Requests for additional time may be approved for up to 90 days. Extensions and/or additional funding may be approved if sufficient justification is provided. If sufficient need is not provided, the RA may deny the request for extension and/or additional funding.

Federal award: The Federal financial assistance that an STT government receives directly from a Federal awarding agency or indirectly from a pass-through entity.

Federal awarding agency: The Federal agency that provides a Federal award directly to an STT government.

Household: All persons (adults and children) who lived in the pre-disaster residence, as well as any persons, such as infants, spouses, or part-time residents who were not present at the time of the disaster, but who are expected to return during the assistance period.²⁵⁰

Information and Referral (I&R): The provision of disaster-related resource information provided to disaster survivors to meet immediate unmet needs. Referrals may include those for temporary shelter, food, clothing, and medical assistance. I&R also refers to the ongoing process by which case managers facilitate a disaster survivor's access to needed services throughout the DCM life cycle.

Long-Term Recovery Group: A cooperative body that is made up of representatives from faith-based, nonprofit, government, business, and other organizations moving within a community to assist individuals and families as they recover from disaster.²⁵¹

Non-Federal entity: An SLTT government, or a private organization that carries out a Federal award as a recipient or subrecipient, or as referenced in previous guidance, a grantee or sub-grantee.

Nonprofit organization: Nonprofit organization means any corporation, trust, association, cooperative, or other organization, not including Institutes of Higher Education, that is operated primarily for scientific, educational, service, charitable, or similar purposes in the public interest, is not organized primarily for profit and uses net proceeds to maintain, improve, or expand the operations of the organization.

Pass-through entity: An STT government that provides a subaward to a subrecipient to carry out part of a Federal program.

Performance goal: A target level of performance expressed as a tangible, measurable objective, against which actual achievement can be compared, including a goal expressed as a quantitative standard, value, or rate. In some instances (e.g., discretionary research awards), this may be limited to the requirement to submit technical performance reports (to be evaluated in accordance with agency policy).

Period of Performance: Per 2 C.F.R. § 200.77, period of performance for a Federal award means the time during which the non-Federal entity may incur new obligations to carry-out the work authorized under the Federal Award.

Pre-Award Costs: Per 2 C.F.R. § 200.209, pre-award costs for a Federal award are costs incurred by the applicant prior to the start date of the period of performance.

Reasonable Accommodations or Modifications: Under Section 504 of the Rehabilitation Act of 1973 and Section 308 of the Stafford Act, FEMA is required to provide reasonable accommodations or modifications to policies, practices, and procedures to ensure equal access to qualified applicants with disabilities. Reasonable accommodations may include the provision of technologies and services to ensure equal access to disaster assistance. Disaster survivors with disabilities have a right to equal access to FEMA programs and activities, including FEMA's registration process and housing inspections, physical access to facilities, and effective communication.

Recipient: An STT government mental health agency, or other local or private mental health organization which is designated by the Governor, Governor's Authorized Representative (GAR), or Tribal Chief Executive, or Tribal Chief Executive's Authorized Representative (TAR) to receive funds under Section 416 of the Stafford Act. This definition aligns with the program specific definition of a grantee, as per 44 C.F.R. § 200.171 (b)(5), and the Federal award definition of a recipient, as per 2 C.F.R. § 200.86.

Service Providers: Any entity providing DCM services at the local level. These agencies include, but are not limited to, nonprofit, voluntary, faith-based, and/or private not-for-profit organizations that provide DCM services to disaster survivors.

Subaward: An award provided by a pass-through entity to a subrecipient for the subrecipient to carry out part of a Federal award received by the pass-through entity. It does not include payments to a contractor or payments to an individual that is a beneficiary of a Federal program. A subaward may be provided through any form of legal agreement, including an agreement that the pass-through entity considers a contract.

Subrecipient: An STT government that receives a subaward from a pass-through entity to carry out part of a Federal program; does not include an individual that is a beneficiary of such program.

Supplant: STT governments may not use Crisis Counseling Assistance and Training Program (CCP) funds to take the place of or serve as a substitute for previously existing state or local activities.

Supplemental: If sufficient justification is provided by the state workforce agency, requests for supplemental funding may be approved by the RA.

Appendix I: Abbreviations and Acronyms

Abbreviation/Acronyms	Definition
AA	Assistant Administrator
ABFE	Advisory Base Flood Elevation
ACS	Adventist Community Services
ADA	Americans with Disabilities Act
ADAAG	Americans with Disabilities Act Accessibility Guidelines
ADL	Activities of Daily Living
AFHI	Advisory Flood Hazard Information
AFMV	Adjusted Fair Market Value
ALAN	American Logistics Aid Network
ALE	Additional Living Expense
ASL	American Sign Language
ASPR	Assistant Secretary for Preparedness and Response
AT	Advanced Technology
AWG	Administrative Wage Garnishment
BFE	Base Flood Elevation
BPA	Blanket Purchase Agreements
CARB	California Air Resources Board
CART	Communication Access Real-time Translation
CBRA	Coastal Barrier Resources Act
CBRS	Coastal Barrier Resources System
CCP	Crisis Counseling Assistance and Training Program
CDC	Centers for Disease Control and Prevention
C.F.R.	Code of Federal Regulations
CMHS	Center for Mental Health Services

Appendix I: Abbreviations and Acronyms

Abbreviation/Acronyms	Definition
CMS	Consumable Medical Supplies
CNA	Critical Needs Assistance
CNCS	Corporation for National and Community Service
CRA	Clean and Removal Assistance
CTN	Critical Transportation Needs
CUSI	Commonly Used Shelter Items
DCIA	Debt Collection Improvement Act
DCM	Disaster Case Management
DFA	Direct Federal Assistance
DHAP	Disaster Housing Assistance Program
DHAT	Direct Housing Assessment Team
DHS	Department of Homeland Security
DHTF	Disaster Housing Task Force
DLS	Disaster Legal Services
DME	Durable Medical Equipment
DOB	Duplication of Benefits
DOD	Department of Defense
DOJ	Department of Justice
DOL	Department of Labor
DRC	Disaster Recovery Center
DSA	Disaster Survivor Assistance
D-SNAP	Disaster Supplemental Nutrition Assistance Program
DTAC	Disaster Technical Assistance Center
DUA	Disaster Unemployment Assistance
EHP	Environmental Planning and Historic Preservation
EMI	Emergency Management Institute
EOC	Emergency Operations Center

Abbreviation/Acronyms	Definition
EOP	Emergency Operations Plan
EOs	Executive Orders
ESF	Emergency Support Function
ESF6-SS	Emergency Support Function #6-Support Systems
FAQ	Frequently Asked Questions
FAR	Federal Acquisition Regulation
FCO	Federal Coordinating Officer
FEMA	Federal Emergency Management Agency
FFC	FEMA Finance Center
FIID	Fraud and Internal Investigations Division
FIOP	Federal Interagency Operational Plan
FIRM	Flood Insurance Rate Map
FMR	Fair Market Rent
FODAC	Friends of Disabled Adults and Children
FOIA	Freedom of Information Act
FVL	FEMA-Verified Loss
GAO	Government Accountability Office
GAR	Governor's Authorized Representative
GFIP	Group Flood Insurance Policy
GIS	Geographic Information System
GMO	Grants Management Officer
GSA	General Services Administration
HA	Housing Assistance
HHS	Health and Human Services
HPSA	Household Pets and Service and Assistance Animals
HQ	Headquarters
HQS	Housing Quality Standards

Appendix I: Abbreviations and Acronyms

Abbreviation/Acronyms	Definition
HUD	Department of Housing and Urban Development
HVAC	Heating, Ventilation, and Air Conditioning
IA	Individual Assistance
IAA	Interagency Agreement
IADD	IA Division Director
IAPPG	Individual Assistance Program and Policy Guide
IAS	International Assistance System
IASC	Individual Assistance Support Contracts
IDCM	Immediate Disaster Case Management
IDEA	Individuals with Disabilities Education Act
IDIQ	Indefinite Delivery Indefinite Quantity
IEP	Individualized Educational Plan
IHP	Individuals and Households Program
IOF	Initial Operating Facility
IPERA	Improper Payments Elimination and Recovery Act
IPERIA	Improper Payments Elimination and Recovery Improvement Act
IPIA	Improper Payments and Information Act
I&R	Information and Referral
ISP	Immediate Services Program
JFO	Joint Field Office
LEP	Limited English Proficiency
LER	Lodging Expense Reimbursement
LOU	Loss of Use
MASTF	Multi-agency Sheltering Task Force
MC/EA	Mass Care/Emergency Assistance
MHU	Manufactured Housing Unit
MLR	Multi-Family Lease and Repair

Appendix I: Abbreviations and Acronyms

Abbreviation/Acronyms	Definition
MOA	Memorandum of Agreement
MOU	Memorandum of Understanding
N/A	Not Applicable
NAMB	North American Mission Board
NARSC	National Animal Rescue and Sheltering Coalition
NASAAEP	National Alliance of State Animal and Agriculture Emergency Programs
NASDoVoC	National Association of State Emergency Donations and Volunteer Coordinators
NCIL	National Council on Independent Living
NDL	Notice and Demand Letter
NDMS	National Disaster Medical System
NDRF	National Disaster Recovery Framework
NDRN	National Disability Rights Network
NECLC	National Emergency Child Locator Center
NEMIS	National Emergency Management Information System
NETC	National Emergency Training Center
NFIP	National Flood Insurance Program
NFIRA	National Flood Insurance Reform Act
NGO	Non-Governmental Organization
NMCE	National Mass Care Exercise
NOA	Notice of Award
NOR	Notice of Revocation
NPG	National Preparedness Goal
NRCC	National Response Coordination Center
OIG	Office of Inspector General
OMB	Office of Management and Budget

Appendix I: Abbreviations and Acronyms

Abbreviation/Acronyms	Definition
ONA	Other Needs Assistance
OPA	Otherwise Protected Area
PA	Public Assistance
PAPPG	Public Assistance Policy and Program Guide
PAS	Personal Assistance Services
PHC	Permanent Housing Construction
PHP	Permanent Housing Plan
PII	Personally Identifiable Information
PKEMRA	Post-Katrina Emergency Management Reform Act
PMS	Payment Management System
PNP	Private Non-Profit
PO	Program Officer
POD	Proof of Debt
POP	Period of Performance
PPD	Presidential Policy Directive
PSMA	Pre-Scripted Mission Assignments
RA	Regional Administrator
ROE	Right of Entry
RRCC	Regional Response Coordination Center
RSF	Recovery Support Function
RSP	Regular Services Program
RSVP	Retired and Senior Volunteer Program
RV	Recreational Vehicle
SAMHSA	Substance Abuse and Mental Health Services Administration
SAP	State Administrative Plan
SBA	U.S. Small Business Administration
SBDR	Southern Baptist Disaster Relief

Appendix I: Abbreviations and Acronyms

Abbreviation/Acronyms	Definition
SCO/TCO	State or Territorial Coordinating Officer
SFHA	Special Flood Hazard Area
SLTT	State, local, territorial, or tribal
SME	Subject Matter Expert
SPOC	Single Point of Contact
SSA	Social Security Administration
SSN	Social Security Number
STT	State, territorial, or tribal
THU	Temporary Housing Unit
TPS	Tank and Pump System
TSA	Transitional Sheltering Assistance
TTHU	Transportable Temporary Housing Unit
TTY	Text Telephone
UFAS	Uniform Federal Accessibility Standards
UI	Unemployment Insurance
UMR	Unaccompanied Minor Registry
USACE	United States Army Corps of Engineers
USDA	United States Department of Agriculture
VA	Department of Veterans Affairs
VAL	Voluntary Agency Liaison
VISTA	Volunteers in Service to America
VOAD	Voluntary Organizations Active in Disasters
VRI	Video Remote Interpreting
VRS	Video Relay Service
YLD	Young Lawyers Division

This page is intentionally blank.

Endnotes

- ¹ Stafford Act § 102(4), 42 U.S.C. § 5122 and Title 44 of the Code of Federal Regulations (C.F.R.) § 206.2(a)(22), state governments include the District of Columbia, American Samoa, the Commonwealth of the Northern Mariana Islands, Guam, Puerto Rico, and the U.S. Virgin Islands.
- ² Stafford Act § 102(8), 42 U.S.C. § 5122, and 44 C.F.R. § 206.2(a)(16), local governments include counties or parishes, municipalities, cities, towns, townships, local public authorities, school districts, special districts established under state law, intrastate districts, councils of governments (regardless of whether the council of governments is included as a nonprofit corporation under State law), regional or interstate government entities, agencies or instrumentalities of a local government; state-recognized tribes; and rural communities, unincorporated towns or villages, or other public entities, for which an application for assistance is made by a state or political subdivision of a state.
- ³ Stafford Act § 102(6), 42 U.S.C. § 5112, and 44 C.F.R. § 206.201(i), a Tribal Government refers to any Native American tribe, band, nation, pueblo, village, or community in the continental U.S. and Alaska that is listed as a tribe under the Federal Recognized Native American Tribe List Act of 1994.
- ⁴ See [Robert T. Stafford Disaster Relief and Emergency Assistance Act](#).
- ⁵ Stafford Act § 102(12), 42 U.S.C. § 5122
- ⁶ 44 C.F.R. § 206.35(a) and 206.36(a)
- ⁷ 44 C.F.R. § 206.110(c)
- ⁸ Voluntary Agency Coordination may take place prior to and during Emergency Declarations and Major Disaster Declarations.
- ⁹ Stafford Act § 408(g), 42 U.S.C. § 5174(g) and 44 C.F.R. § 206.110(i).
- ¹⁰ TSA is authorized under Sections 403 or 502 of the Stafford Act and implemented under Section 408.
- ¹¹ *Id.*
- ¹² Stafford Act Section 102(1), 42 U.S.C. § 5122
- ¹³ Stafford Act § 102(1), 42 U.S.C. § 5122, and 44 C.F.R. § 206.2(a)(17)
- ¹⁴ 44 C.F.R. § 206.32(d)
- ¹⁵ 44 C.F.R. § 206.44
- ¹⁶ 44 C.F.R. § 206.32(f)
- ¹⁷ 44 C.F.R. § 206.2(a)(6)
- ¹⁸ 44 C.F.R. § 206.32(d)
- ¹⁹ See also 44 C.F.R. § 206.11(c) (requiring organizations or governments receiving assistance under the Stafford Act to provide a written assurance of their intent to comply with regulations relating to nondiscrimination).
- ²⁰ 44 C.F.R. § 206.110(f)
- ²¹ 44 C.F.R. § 206.110(g)
- ²² 44 C.F.R. § 206.119(b)
- ²³ 44 C.F.R. § 206.117(b)(ii)
- ²⁴ 44 C.F.R. § 206.119(a)
- ²⁵ 44 C.F.R. § 206.110(e)
- ²⁶ Stafford Act Section 426, 42 U.S.C. § 5189d
- ²⁷ Stafford Act Section 416, 42 U.S.C. § 5183; 44 C.F.R. § 206.171
- ²⁸ Stafford Act Section 415, 42 U.S.C. § 5182, 44 C.F.R. § 206.164
- ²⁹ Stafford Act Section 410, U.S.C. § 5177, 44 C.F.R. § 206.141
- ³⁰ 44 C.F.R. § 206.191(d)(2)
- ³¹ 29 U.S.C. § 701 et seq.
- ³² 29 U.S.C. § 794 and 42 U.S.C. § 5151, respectively
- ³³ Stafford Act, codified at 42 U.S.C. § 5151; Executive Order 13166, Improving Access to Services for Persons with Limited English Proficiency, August 11, 2000
- ³⁴ Mass Care/Emergency Assistance is authorized under Sections 402, 403, and 502 of the Robert T. Stafford Disaster Relief and Emergency Assistance Act, Public Law 93-288, as amended; 42 U.S.C. § 5121 (Stafford Act); and Title 6 U.S.C. § 774 and 775
- ³⁵ Section 402 (a)(3)(j) authorizes the provision of rescue, care, shelter and essential needs...for individuals and their household pets, service animals, and assistance animals.
- ³⁶ The authorities governing the declaration of a disaster and the ensuing sheltering support by FEMA MC/EA are the Stafford Act (Sections 309, 402, 403, 502, 775).
- ³⁷ The authorities governing the declaration of a disaster and the emergency feeding support by FEMA MC/EA are the Stafford Act (Sections 309, 402, 403, 412, 413, and 502).
- ³⁸ The authority governing the declaration of a disaster and the ensuing distribution of emergency supplies by FEMA MC/EA is the Stafford Act (Sections 309, 402, 403, 502).
- ³⁹ Section 308 of the Stafford Act, 42 U.S.C. § 5151
- ⁴⁰ The authorities governing the declaration of a disaster and the Personal Assistance Services support by FEMA MC/EA are the Robert T. Stafford Disaster Relief and Emergency Assistance Act (Sections 402, 403, 502), The Rehabilitation Act of 1973 (Provisions of 504 and 508), ADA of 1990 (and as amended in 2008), Architectural Barriers Act of 1968, Fair Housing Act of 1968 (and as amended in 1988), Air Carrier

Access Act of 1986, and the UFAS of 1984. FEMA personal assistance contracts are governed by Section 3(2) of the ADA of 1990 (42 U.S.C. 12102(2) and the Stafford Act (Public Law 93-288).

⁴¹ Support to children in disasters was added in the June 2016 (version 3) of the ESF6 Annex.

⁴² The authorities governing the declaration of a disaster and the ensuing deployment of reunification services by FEMA MC/EA are the Stafford Act (Section 403), and Title 6 U.S.C. § 774. NECLC is authorized under the Stafford Act (Sections 403 and 774).

⁴³ The authorities governing the declaration of a disaster and the ensuing household pets, service animals, and assistance animals support by FEMA MC/EA are the Stafford Act (Sections 309, 402, 403, 502, 611, and 613).

⁴⁴ The authorities governing the declaration of a disaster and the ensuing deployment of mass evacuee assistance by FEMA MC/EA are the Stafford Act (Sections 309, 402, 403, 502), and Title 6 U.S.C. § 774 and 775.

⁴⁵ Section 403, 42 U.S.C. § 5170b, Essential Assistance; Section 408, 42 U.S.C. § 5174, Federal Assistance to Individuals and Households; and Section 502, 42 U.S.C. § 5192, Federal Emergency Assistance, of the Robert T. Stafford Disaster Relief and Emergency Assistance Act, as amended.

⁴⁶ IRC Section 61(a), and Sections 139(a),(b)(1), (b)(4), (c)(2), (c)(4), and (h)

⁴⁷ 44 C.F.R. § 206.110(f)

⁴⁸ 44 C.F.R. § 206.110(g)

⁴⁹ Stafford Act § 408(c)(1)(B)(iii), 42 U.S.C. § 5174(c)(1)(B)(iii) and 44 C.F.R. § 206.110(e).

⁵⁰ 44 C.F.R. § 206.110(e).

⁵¹ 44 C.F.R. § 206.110(e)

⁵² Stafford Act § 408(h), 42 U.S.C. § 5174(h) and 44 C.F.R. § 206.110(b)

⁵³ The Disaster Recovery Reform Act (DRRA) of 2018 amends the Stafford Act 408(h) to remove Temporary Housing Assistance from any financial maximum and separates Other Needs Assistance (ONA) so ONA and Home Repair Assistance/Home Replacement Assistance have equal, independent financial maximums.

⁵⁴ This minimum is only limited to initial IHP awards. There is no minimum award amount for secondary awards.

⁵⁵ Stafford Act § 408(b)(2)(B), 42 U.S.C. § 5174(b)(2)(B) and § 206.110(c)

⁵⁶ Stafford Act § 408(h), 42 U.S.C. § 5174(h) and 44 C.F.R. § 206.110(b)

⁵⁷ Stafford Act § 408(c)(1)(A)(i), 42 U.S.C. 5174 (c)(1)(A)(i) and 44 C.F.R. 206.117(b)(1)(i)

⁵⁸ *Id.*; 44 § C.F.R. 206.111

⁵⁹ Stafford Act § 408(c)(2), 42 U.S.C. § 5174 (c)(2) and 44 C.F.R. § 206.117(b)(2)

⁶⁰ Stafford Act § 408(c)(3), 42 U.S.C. § 5174(c)(2) and 44 C.F.R. § 206.117(b)(3)

⁶¹ Stafford Act § 408(c)(1)(B)(i), 42 U.S.C. § 5174(c)(1)(B)(i) and 44 C.F.R. § 206.117(b)(1)(ii)

⁶² Stafford Act § 408(c)(1)(B)(ii), 42 U.S.C. § 5174(c)(1)(B)(ii)

⁶³ Stafford Act § 408(c)(4), 42 U.S.C. § 5174(c)(4) and 44 C.F.R. § 206(b)(4)

⁶⁴ Stafford Act § 408(e), 42 U.S.C. § 5174(e) and 44 C.F.R. § 206.119

⁶⁵ 42 U.S.C. § 5174(i)

⁶⁶ Stafford Act § 408(a)(1), 42 U.S.C. § 5174(a)(1). Disaster Operations Legal Reference, Version 2.0, Department of Homeland Security, June 1, 2013

⁶⁷ *Id.*

⁶⁸ Stafford Act § 408(i), 42 U.S.C. § 5174(i)

⁶⁹ 44 C.F.R. § 206.113(a)(3)

⁷⁰ 44 C.F.R. § 206.113(a)(3)

⁷¹ 44 C.F.R. § 206.111

⁷² 44 C.F.R. § 206.111

⁷³ National Flood Insurance Program, Dwelling Form: Standard Flood Insurance Policy. F-122. October 2015.

⁷⁴ 16 U.S.C. § 3504

⁷⁵ 44 C.F.R. § 206.113(b)(7)

⁷⁶ 44 C.F.R. § 206.113(b)(7)

⁷⁷ 44 C.F.R. § 61, Appendix A(1) and A(3)

⁷⁸ 44 C.F.R. § 61

⁷⁹ 44 C.F.R. § 206.110(k)(3)

⁸⁰ 44 C.F.R. § 61.17 Appendix A.III.6

⁸¹ 44 C.F.R. § 206.115

⁸² 44 C.F.R. § 206.115(a)

⁸³ 44 C.F.R. § 206.115(b)

⁸⁴ 44 C.F.R. § 206.115(f)

⁸⁵ *Id.*

⁸⁶ 42 U.S.C. § 5151(a); 44 C.F.R. § 7

⁸⁷ 44 C.F.R. § 206.112(a)

⁸⁸ 44 C.F.R. § 206.112(c)

⁸⁹ 44 C.F.R. § 206.110(i)

⁹⁰ 44 C.F.R. § 206.111

- ⁹¹ 44 C.F.R. § 206.110
- ⁹² 44 C.F.R. § 206.117(b)(1)(i)
- ⁹³ 44 C.F.R. § 206.110
- ⁹⁴ 42 U.S.C. § 5174(c)(1)(A)(i) and 44 C.F.R. § 206.117(b)(1)(i)
- ⁹⁵ 44 C.F.R. § 206.111
- ⁹⁶ 44 C.F.R. § 206.117(b)(1)(i)(B)
- ⁹⁷ 44 C.F.R. § 206.117(b)(1)(i)(C)
- ⁹⁸ 44 C.F.R. § 206.113(b)(2)
- ⁹⁹ 44 C.F.R. § 206.111
- ¹⁰⁰ 44 C.F.R. § 206.113(b)(3)
- ¹⁰¹ 44 C.F.R. § 206.117(b)(1)(i)(A)
- ¹⁰² 44 C.F.R. § 206.114(a)
- ¹⁰³ 44 C.F.R. § 206.114(b)(3)
- ¹⁰⁴ 44 C.F.R. § 206.111
- ¹⁰⁵ 44 C.F.R. § 206.111
- ¹⁰⁶ 44 C.F.R. § 206.114(b)(2)
- ¹⁰⁷ 44 C.F.R. § 206.114(b)(2)
- ¹⁰⁸ 42 U.S.C. § 5174(c)(2) and 44 C.F.R. § 206.114(b)(2)
- ¹⁰⁹ The definition of the term ‘basement’ comes from 44 C.F.R. § 59.1
- ¹¹⁰ 44 C.F.R. § 206.117(b)(2)(ii)(F)
- ¹¹¹ PHC does not count towards the financial Housing Assistance maximum award, but an applicant is not eligible for financial Home Repair or Home Replacement Assistance if they choose PHC. If accepting PHC, the applicant must disclose and return any funds determined to be a duplication of benefits to FEMA prior to construction, if already awarded Home Repair or Home Replacement Assistance
- ¹¹² 42 U.S.C. § 5174(c)(1)(B) and 44 C.F.R. § 206.117(b)(1)(ii)
- ¹¹³ 42 U.S.C. § 5174(c)(4) and 44 C.F.R. § 206.117(b)(4)
- ¹¹⁴ Stafford Act, codified at 42 U.S.C. § 5174, 408(c)(B)(1)
- ¹¹⁵ This threshold is based on a 2019 statistical analysis of FEMA direct housing operations from 2011 to 2018.
- ¹¹⁶ Resource: Department of Housing and Urban Development (HUD) – Housing Quality Standards.
- ¹¹⁷ 44 C.F.R. § 206.117(b)(1)(ii)(G)
- ¹¹⁸ 44 C.F.R. § 206.117(b)(1)(ii)(H)
- ¹¹⁹ 42 U.S.C. § 5174(c)(1)(B)(iii)
- ¹²⁰ 44 C.F.R. § 206.117(b)(1)(ii)(F)
- ¹²¹ 44 C.F.R. § 206.117(b)(1)(ii)(F)
- ¹²² For example, if the original period of assistance ends on March 24, 2016, and the extension is granted, rent will begin to accrue on April 1, 2016
- ¹²³ For example, if rent begins to accrue on April 1, 2016, the primary occupant’s first monthly rent payment will be due on May 1, 2016
- ¹²⁴ 44 C.F.R. § 206.117(b)(1)(ii)(G)
- ¹²⁵ 42 U.S.C. § 5174(c) (1)(B)(ii)
- ¹²⁶ <https://www.access-board.gov/guidelines-and-standards/buildings-and-sites/about-the-ada-standards/background/adaag>
- ¹²⁷ https://www.huduser.gov/portal/publications/destech/design_details.html
- ¹²⁸ Landlords may not prohibit service animals or charge “pet rent” or a pet deposit for service animals (Fair Housing Act, 42 U.S.C. § 3601 – 3619)
- ¹²⁹ 24 C.F.R. § 3280, Manufactured Home Construction and Safety Standards.
- ¹³⁰ In accordance with 44 C.F.R. § 9.13
- ¹³¹ 44 C.F.R. § 9.13, Executive Order 11988 - Floodplain Management, Executive Order 11990 - Protection of Wetlands, and FEMA Instruction 108-1-1.
- ¹³² Dispose means to release a unit from FEMA’s inventory
- ¹³³ 42 U.S.C. § 5174(d)(2)(B); 44 C.F.R. § 206.118
- ¹³⁴ 42 U.S.C. § 5174(d)(2)(A)(i); 44 C.F.R. § 206.118(a)(1)(i)
- ¹³⁵ FEMA will use the MHU Depreciation Calculator to identify the AFMV of a unit.
- ¹³⁶ 42 U.S.C. § 4012(a)
- ¹³⁷ 44 C.F.R. § 9.6
- ¹³⁸ 42 U.S.C. § 5174(d)(2)(B)(ii); 44 C.F.R. § 206.118(a)(2)(i)
- ¹³⁹ 42 U.S.C. § 5174(d)(2)(B)(ii); 44 C.F.R. § 206.118(a)(2)(i)
- ¹⁴⁰ 42 U.S.C. § 5174(d)(2)(B)(ii)(b); 44 C.F.R. § 206.118(a)(2)(i)(B)
- ¹⁴¹ 42 U.S.C. § 5151; 44 C.F.R. § 206.118(a)(2)(i)(A)
- ¹⁴² 42 U.S.C. § 5174(c)(1)(B)(i)
- ¹⁴³ Landlords may not prohibit service animals or charge “pet rent” or a pet deposit for service animals. (Fair Housing Act, 42 U.S.C. § 3601 – 3619)
- ¹⁴⁴ 42 U.S.C. § 5174(c)(4) and 44 C.F.R. § 206.117(b)(4)

- ¹⁴⁵ 44 C.F.R. § 206.117(2)(ii)
- ¹⁴⁶ 44 C.F.R. § 206.110(k)(3)
- ¹⁴⁷ 42 U.S.C. § 5174(e)
- ¹⁴⁸ 42 U.S.C. § 5174(g)
- ¹⁴⁹ Refer to *Chapter 1: Introduction*, for further information on the relationship between IHP and other forms of assistance, including SBA.
- ¹⁵⁰ 42 U.S.C. § 5174(h)
- ¹⁵¹ 44 C.F.R. § 206.120(b)
- ¹⁵² 44 C.F.R. § 206.120(a) and (b)
- ¹⁵³ 44 C.F.R. § 206.120(d)
- ¹⁵⁴ 44 C.F.R. § 206.120(a)
- ¹⁵⁵ 44 C.F.R. § 206.120(c)(1)
- ¹⁵⁶ 44 C.F.R. § 206.120(b)
- ¹⁵⁷ 44 C.F.R. § 206.120(c)(1).
- ¹⁵⁸ 44 C.F.R. § 206.120(c) and (d)
- ¹⁵⁹ *Id*
- ¹⁶⁰ 44 C.F.R. § 206.120(c)(3)(i) and 44 C.F.R. § 206.120(c)(3)(ii)
- ¹⁶¹ 44 C.F.R. § 206.119(c)(4)
- ¹⁶² <https://www.cdc.gov/nchs/data/nvss/vsrg/vsrg01.pdf>
- ¹⁶³ 44 C.F.R. § 206.119(c)(3)(i) and (ii)
- ¹⁶⁴ 42 U.S.C. § 5174 (e)(1)
- ¹⁶⁵ 42 U.S.C. § 12102(1) defines disability to mean, “(A) a physical or mental impairment that substantially limits one or more major life activities of such individual; (B) a record of such an impairment; and (C) being regarded as having such an impairment...”
- ¹⁶⁶ 34 C.F.R. § 104.
- ¹⁶⁷ 44 C.F.R. § 206.119(c)(6)(ii)
- ¹⁶⁸ 44 C.F.R. § 206.120(c)(3)(i) and (ii)
- ¹⁶⁹ 44 C.F.R. § 206.119(c)(5)
- ¹⁷⁰ *Id*
- ¹⁷¹ 44 C.F.R. § 206.119(c)(1)
- ¹⁷² 44 C.F.R. § 206.119(c)(2)
- ¹⁷³ 44 C.F.R. § 206.119(c)(6)(ii)
- ¹⁷⁴ 44 C.F.R. § 206.119(d) and 44 C.F.R. § 61.17
- ¹⁷⁵ 44 C.F.R. 61.17(b)
- ¹⁷⁶ 44 C.F.R. § 206.119(c)(6)(i) and (d)(2)
- ¹⁷⁷ 44 C.F.R. § 61, Appendix A (1)
- ¹⁷⁸ Section 312(c) of the Stafford Act, 42 U.S.C. § 5155(c) and 44 C.F.R. § 206.191
- ¹⁷⁹ Stafford Act § 312, 42 U.S.C. § 5155
- ¹⁸⁰ 44 C.F.R. § 206.116
- ¹⁸¹ Examples of “Certain Federal benefit payments” include Social Security (other than Supplemental Security Income), Railroad Retirement (other than tier 2), and Black Lung (part B) benefits, and other Federal payments including certain loans that are not exempt from offset.
- ¹⁸² Section 426 of the Robert T. Stafford Disaster Relief and Emergency Assistance Act, 42 U.S.C. § 5189d.
- ¹⁸³ 2 C.F.R. § 200.458
- ¹⁸⁴ 2 C.F.R. § 200.303
- ¹⁸⁵ Section 423 of the Stafford Act (42 U.S.C. § 5189(a))
- ¹⁸⁶ 42 U.S.C. § 5189(a)
- ¹⁸⁷ 2 C.F.R. § 200.339
- ¹⁸⁸ 2 C.F.R. § 200.327-328
- ¹⁸⁹ 2 C.F.R. § 200.327
- ¹⁹⁰ 2 C.F.R. § 200.343 and 200.309
- ¹⁹¹ 2 C.F.R. § 200.333
- ¹⁹² 2 C.F.R. § 200.333(c)
- ¹⁹³ 2 C.F.R. § 200.333(a)
- ¹⁹⁴ 2 C.F.R. § 200.333(b)
- ¹⁹⁵ 2 C.F.R. § 200.333(e)
- ¹⁹⁶ 2 C.F.R. § 200.333(f)
- ¹⁹⁷ 44 C.F.R. § 206.171
- ¹⁹⁸ Section 416 of the Robert T. Stafford Disaster Relief and Emergency Assistance Act, 42 U.S.C. § 5183.
- ¹⁹⁹ 44 C.F.R. § 206.171
- ²⁰⁰ 44 C.F.R. § 206.171 (f)(1)(i)(ii)

- 201 2 C.F.R. § 200.458
- 202 44 C.F.R. § 206.171(f)(3)
- 203 44 C.F.R. § 206.171(f)(3)
- 204 2 C.F.R. § 200.333
- 205 2 C.F.R. § 200.333(c)
- 206 2 C.F.R. § 200.333(a)
- 207 2 C.F.R. § 200.333(b)
- 208 2 C.F.R. § 200.333(e)
- 209 2 C.F.R. § 200.333(f)
- 210 44 C.F.R. § 206.171 (g)(4)(i)
- 211 44 C.F.R. § 206.171 (g)(4)(i)
- 212 2 C.F.R. § 200.333
- 213 2 C.F.R. § 200.333(c)
- 214 2 C.F.R. § 200.333(a)
- 215 2 C.F.R. § 200.333(b)
- 216 2 C.F.R. § 200.333(e)
- 217 2 C.F.R. § 200.333(f)
- 218 2 C.F.R. § 200.113; see also 2 C.F.R. § 180.335, 180.350
- 219 Section 423, Stafford Act (42 U.S.C. § 5189a)
- 220 42 U.S.C. § 5182
- 221 42 U.S.C. § 5177
- 222 Published weekly by DOL
- 223 20 C.F.R. § 625.6
- 224 20 C.F.R. § 625.4 Eligibility requirements for Disaster Unemployment Assistance.
- 225 The Americans with Disabilities Act of 1990 prohibits applicable recipients from discriminating on the basis of disability in employment, the operation of public entities, public and private transportation systems, places of public accommodation, and certain testing entities. In order to ensure compliance, recipients must provide program access, ensure effective communication, and provide physical access for persons with disabilities in developing budgets and in conducting programs and activities.
- 226 <https://www.fema.gov/media-library/assets/documents/32282>
- 227 44 C.F.R. § 206.111
- 228 FEMA itself has similar civil rights responsibilities for the public-facing programs and activities it conducts, such as providing disaster assistance, temporary housing, home inspections, National Flood Insurance Program and Flood Insurance Advocate, public messaging and information, training to state, territorial, and tribal officials, among others. See, e.g., 44 C.F.R. § 16.
- 229 42 U.S.C. § 3601 et seq.
- 230 24 C.F.R. § 100.201
- 231 16 U.S.C. § 470f
- 232 <http://nps.gov/nr/>
- 233 16 U.S.C. § 1531, Section 7
- 234 33 U.S.C. § 1251 et seq.
- 235 42 U.S.C. § 7401 et seq.
- 236 16 U.S.C. § 3501 et seq.
- 237 16 U.S.C. § 3501 and 3503. CBRS maps: www.fws.gov/ecological-services/habitatconservation/cbra/Maps/index.html.
- 238 16 U.S.C. § 3505
- 239 16 U.S.C. § 703–712
- 240 42 U.S.C. § 6901 et seq.
- 241 16 U.S.C. § 1451 et seq.
- 242 7 U.S.C. § 4201 et seq.
- 243 16 U.S.C. § 661–667e
- 244 16 U.S.C. § 1271 et seq.
- 245 16 U.S.C. § 1801–1884
- 246 43 C.F.R. § 10.4(g)
- 247 44 C.F.R. § 9.6, Decision-making process.
- 248 PPD-8 Access and Functional Needs Working Group 2014
- 249 2 C.F.R. § 200.300
- 250 44 C.F.R. § 206.111
- 251 http://www.nvoad.org/wp-content/uploads/2014/05/long_term_recovery_guide_-_final_2012.pdf